

2014/2015

**Passenger Cars
Light trucks**

CATALOGUE CÂBLES

*Câbles automobiles
Automotive cables
Cables para automotores
Cavi per automobili
Kabels voor automobilen*



ACCELERATOR

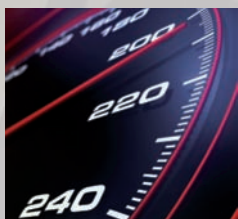

SPEEDOMETER



CLUTCH



BRAKE

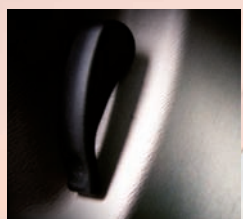

BONNET



SHOKE



NEW : GEAR SHIFTER

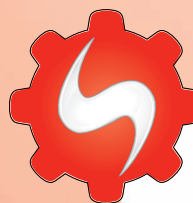

seim

MGJ COUTIER

www.seim.fr



A global automotive supplier offering superior support to independant aftermarket



SEIM

MGI COUTIER

**UN ÉQUIPEMENTIER
MONDIAL
AU SERVICE DE LA
RECHARGE
INDEPENDANTE**

www.seim.fr
www.mgicoutier.com



CÂBLES
CABLES

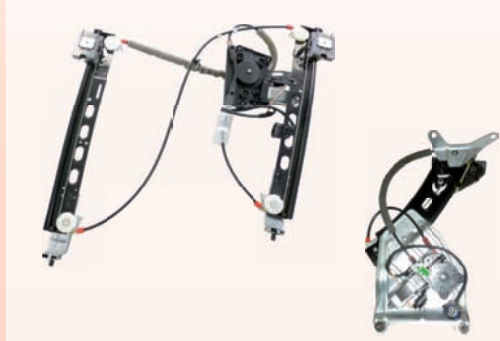

LÈVE - VITRES
POWER WINDOW



LAVAGE
WASHING PARTS



PIÈCES TECHNIQUES
TECHNICAL PARTS

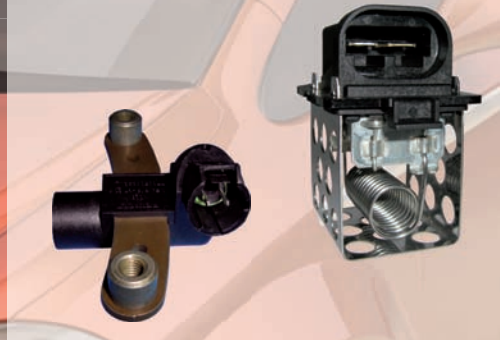

TRANSFERT DE FLUIDES



MGI COUTIER

AVON
AUTOMOTIVE

MÉCANISMES



*Deux domaines
d'expertise, pour des
gammes aftermarket
complètes et innovantes.*



2014-2015

Plus de 430 nouveautés Over 430 news items



Câble de boîte à vitesses
Gear shift cables



**Faites confiance au leader
du marché français !**

Trust the French market leader !

MGI COUTIER SEIM (www.seim.fr) accompagne les plus grands constructeurs mondiaux depuis plus de 60 ans pour leur apporter des solutions fiables et innovantes. Son expertise produit est mondialement reconnue auprès de tous les constructeurs et équipementiers automobiles. Leader sur le marché français, SEIM vous apporte l'ensemble de ses compétences industrielles et techniques pour vous offrir des produits conformes à toutes les plus hautes exigences automobiles.

MGI COUTIER SEIM (www.seim.fr) has been offering to Global Car & Truck Manufacturers for more than 60 years, reliable, innovating and high Value for Money solutions. Both its long, valuable experience and expertise in Cars and Trucks parts production are internationally reknown and appreciated by each and every Car and Truck Makers as well as by System Suppliers. Hence, it enables MGI COUTIER SEIM, the aftermarket division of the MGI COUTIER Group, to leverage this long lasting experience to bring high quality standard for all the product range offered to its IAM distributors.



Sommaire Contents

INFORMATIONS TECHNIQUES TECHNICAL INFORMATION	2
CABLES D'ACCELERATEUR ACCELERATOR CABLES	11
CABLES DE COMPTEUR SPEEDOMETERS CABLES.....	23
 CABLES DE BOÎTE A VITESSES GEAR SHIFT CABLES.....	37
CABLES DE DEBRAYAGE CLUTCH CABLES	45
CABLES DE FREIN BRAKE CABLES	73
TIRETTES DE CAPOT BONNET CABLES.....	165
TIRETTES DE STARTER SHOKE CABLES	169
TIRETTES UNIVERSELLES UNIVERSAL CABLES	173
TABLE DE CORRESPONDANCE CROSS REFERENCE TABLE.....	177

Le câble d'accélérateur Accelerator cable

Le câble d'accélérateur permet, par l'impulsion du pied sur la pédale, de commander l'accélération du moteur.

The accelerator cable allows, the pulse of the foot on the pedal, to control the engine throttle

Il existe deux types de câbles d'accélérateur :

There are two types of accelerator cables :

- Le câble spécifique adapté à un véhicule ou à une motorisation.

- *The specific cable for a vehicle or engine.*

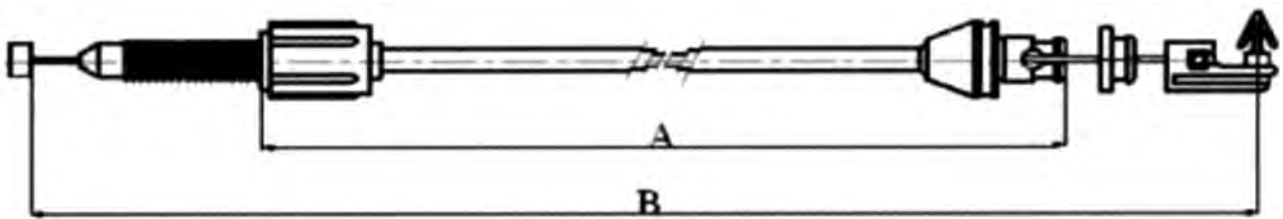

- Le kit de câble comprend plusieurs éléments non assemblés, ce qui lui permet de s'adapter à plusieurs véhicules ou motorisations. Une notice de montage est jointe dans l'emballage en cas de kits compliqués.

- *The cable kit comprises several elements not assembled, which allows it to adapt to various vehicles or engines. A manual is included in the package in case of complicated kits.*

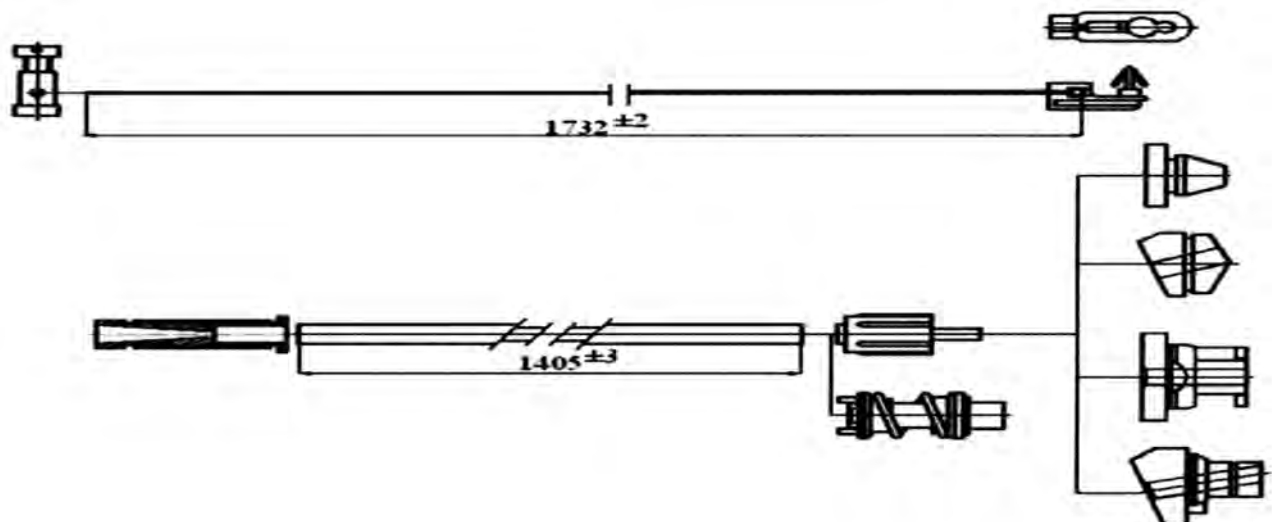

Le câble de compteur Speedometers cable

Le câble de compteur permet de fournir au compteur le nombre de rotations réalisées par la boîte à vitesse afin de calculer la vitesse théorique.

Attention sur certains véhicules les câbles de compteur sont remplacés par des tachymètres électriques.

The speedometer cable provides for the counter the number of rotations made by the gear box in order to calculate the theoretical speed

Caution to certain vehicles speedometer cables are replaced by electric speedometers.

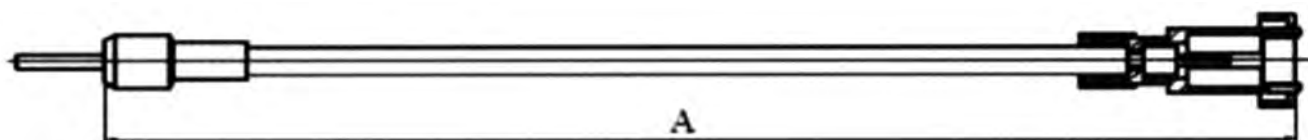

Le câble de boîte à vitesse Gear shift cable

- 1 - Rotule de commande de marche arrière
- 2 - Câble de commande de marche arrière
- 3 - Levier de vitesses
- 4 - Câble de commande de sélection de vitesses
- 5 - Rotule de commande de sélection de vitesses

- 1 - Ball joint reverse control
- 2 - Control reverse cable
- 3 - Gear shift lever
- 4 - Gear shift cable
- 5 - Ball joint gear shift

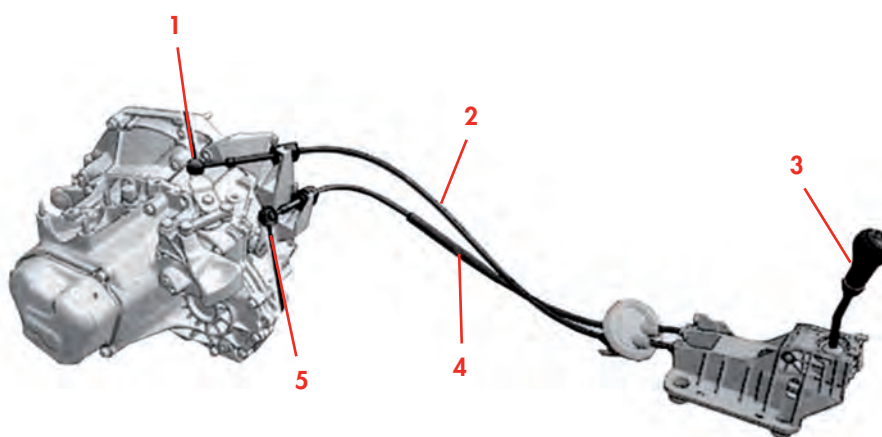

Le câble de boîte à vitesse permet par l'impulsion du levier, d'enclencher les différents rapports de vitesse. C'est un câble spécifique appelé également câble push-pull car il fonctionne en traction et en compression contrairement au câble classique qui ne travaille qu'en traction. Le câble de commande de boîte à vitesse est composé de 2 câbles assemblés ou de deux câbles séparés l'un pour les rapports de marche avant et l'autre pour le rapport de marche arrière.

Gear shift cable allows by the pulse of the lever to engage the different speed ratios. This is a specific cable also called push-pull cable because it works in tension and compression unlike the traditional cable only works in traction. Gear shift cable consists of two cables together or two separate one for the forward gears and one for the reverse gear.

Le câble de débrayage Clutch cable

Le câble de débrayage comme son nom l'indique permet par l'impulsion du pied sur la pédale, de débrayer (désolidariser l'embrayage du volant moteur) pour permettre le changement de rapport de vitesses.

Il existe deux types de câble de débrayage :

- Le câble à rattrapage manuel :

Le réglage de la course se réalise soit en bout de câble, soit en milieu de gaine ou soit en bout de gaine. Il est nécessaire dans le temps de réaliser un nouveau réglage en fonction de l'usure du disque d'embrayage.



- Le câble à rattrapage automatique :

Le réglage de la course se réalise automatiquement et ceci à chaque levée de pédale grâce à un compensateur. Il n'est donc plus nécessaire de réaliser un nouveau réglage en fonction de l'usure du disque d'embrayage.



The clutch cable allows the pulse of the foot on the pedal to disengage (disengage the clutch flywheel) to allowing the change of gear.

There are two types of clutch cables :

- The manual adjusting clutch cable :

The stroke adjustment is carried out either at the end of the cable, either in middle of girdle or either in the end of girdle. It is necessary in the time to make a new setting depending on the wear of the clutch disc.



- The automatic adjusting clutch cable :

The stroke adjustment is performed automatically at each lift and this pedal through a compensator. It is therefore not necessary to make a new setting in depending on the wear of the clutch disc.

Pour ce type de câble il existe trois technologies.

- La première est dite « système à crans ».
- La deuxième est dite « système à billes ».
- Principalement utilisée par Renault et Volkswagen.
- La troisième est dite à « système à galets ».
- Principalement utilisée par Peugeot et Citroën.

Certains câbles à rattrapage automatique sont équipés d'un système de déverrouillage. Ce dispositif doit impérativement être enlevé **après le montage** du câble, ce qui permet de décompresser le compensateur pour que la course du câble s'ajuste automatiquement. Il est tout de même nécessaire d'appuyer plusieurs fois sur la pédale pour l'ajustage.

For this type of cable there are three technologies.

- The first is called « toothed system »
- The second is called « balls system » mainly used on Renault and Volkswagen vehicles.
- The third is called « roller system » mainly used on Peugeot and Citroën vehicles.

Some cables are equipped with an unlocking device. This device must be removed **after the installation** of the cable, which allows, to decompress the compensator so that the cable run is automatically adjusted. It is still necessary to repeatedly press the pedal adjustment.

VERROUILLÉ / LOCKED



DÉVERROUILLÉ / UNLOCKED



Attention
 le dispositif ne doit pas être conservé
 après le montage du câble.

Caution
 device should not be kept
 after the installation of the cable.

En cas d'ouverture accidentelle avant le montage du câble, le dispositif de verrouillage peut être remis en comprimant le compensateur soit en tirant le câble côté pédale, soit côté boîte à vitesses. Nous vous conseillons d'utiliser un étiau pour bloquer le câble afin d'avoir une main libre pour remonter le dispositif de verrouillage.

In case of accidental opening before installing the cable, the locking device can be reset by pressing the compensator either by pulling the cable in the pedal side or in the gearbox side. We recommend to you to use a vise to secure the cable to have a free hand to raise the locking device.

Le câble de frein manuel Manual brake cable

Le câble de frein permet, par l'action exercée sur le frein à main, d'actionner les freins à tambours ou freins à disques afin d'immobiliser le véhicule.

The brake cable, allows the action exerted by the handbrake, activate the drum brakes or disc brakes to stop the vehicle.

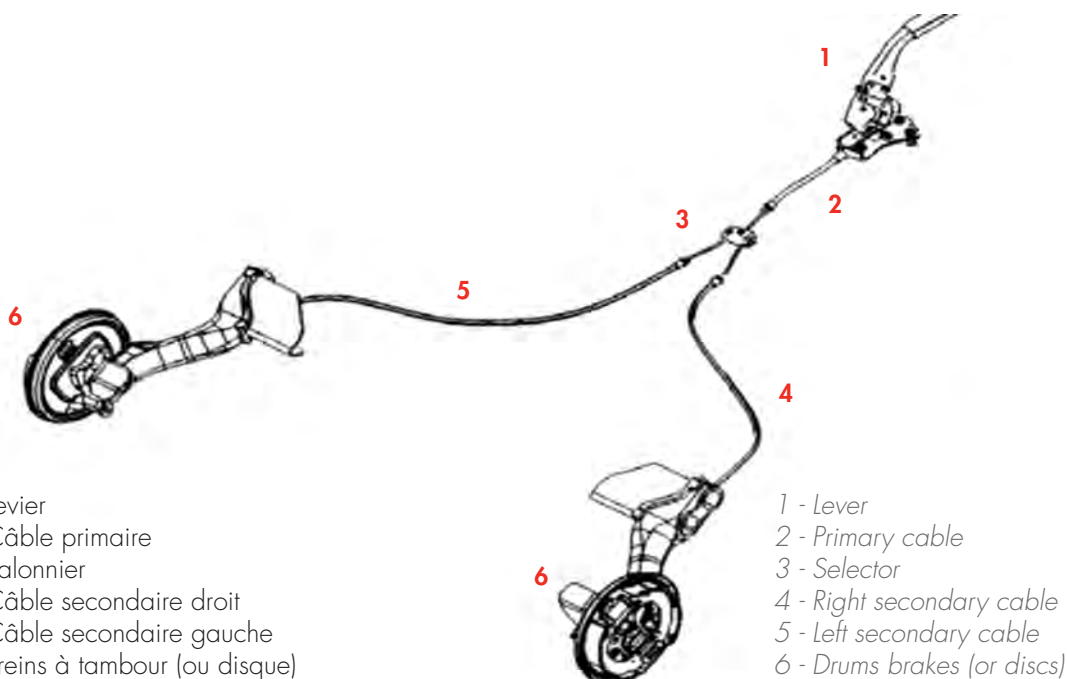

- 1 - Levier
- 2 - Câble primaire
- 3 - Palonnier
- 4 - Câble secondaire droit
- 5 - Câble secondaire gauche
- 6 - Freins à tambour (ou disque)

- 1 - Lever
- 2 - Primary cable
- 3 - Selector
- 4 - Right secondary cable
- 5 - Left secondary cable
- 6 - Drums brakes (or discs)

Généralement le système de câble de freinage dit « frein de parking ou frein de stationnement » se compose de :

Usually the brake cable device called "parking brake" consists of :

- D'un câble de frein primaire relié au frein à main.

- A primary brake cable connected to the handbrake.



De câbles de freins secondaires, reliés ou non au câble de frein primaire. Ils peuvent être composés :

Of secondary brake cables, whether or not related to the primary brake cable. They can be made:

- D'un câble unique articulé à un palonnier

- In a single cable articulated to a brake compensator.



- D'un câble unique sans palonnier

- A single cable without a brake compensator



- De deux câbles identiques ou différents côté gauche et côté droit.

- Two identical cables or different cables in left side and in right side.

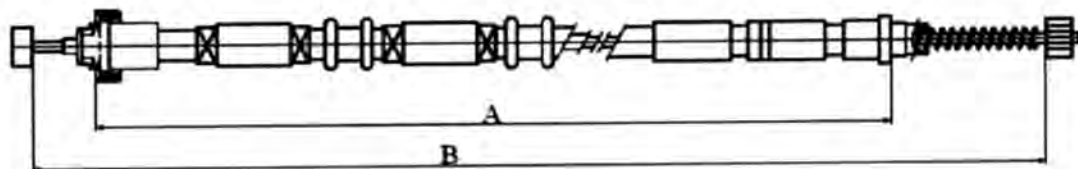

Un câble secondaire unique peut également devenir un câble de frein intermédiaire si un même véhicule est équipé de deux systèmes de freinage. Dans ce cas les constructeurs ajoutent généralement un petit câble dit « câble de liaison » pour pouvoir adapter le câble secondaire au frein à tambours ou au frein à disques.

A single secondary cable may also become an intermediate brake cable even if a vehicle is equipped with two brake devices. In this case manufacturers usually add a small cable says "connection cable" to be able to adapt the secondary cable to the drum brake drum or disc brake.

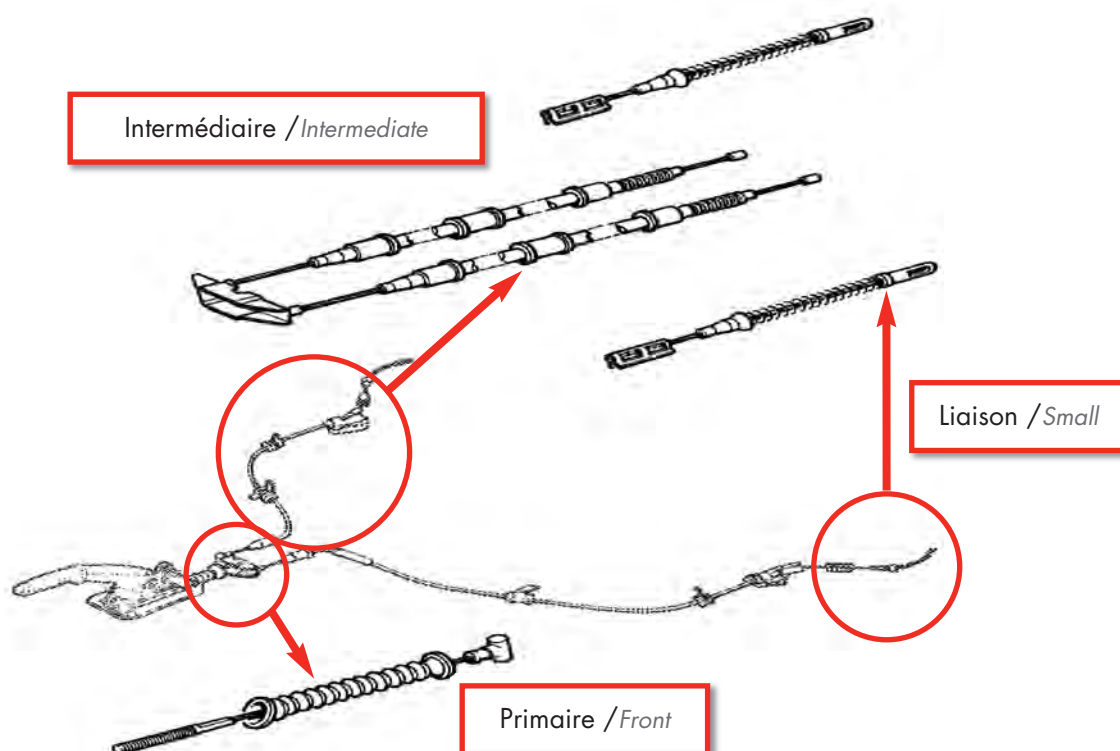

Le câble de frein automatique Automatic brake cable

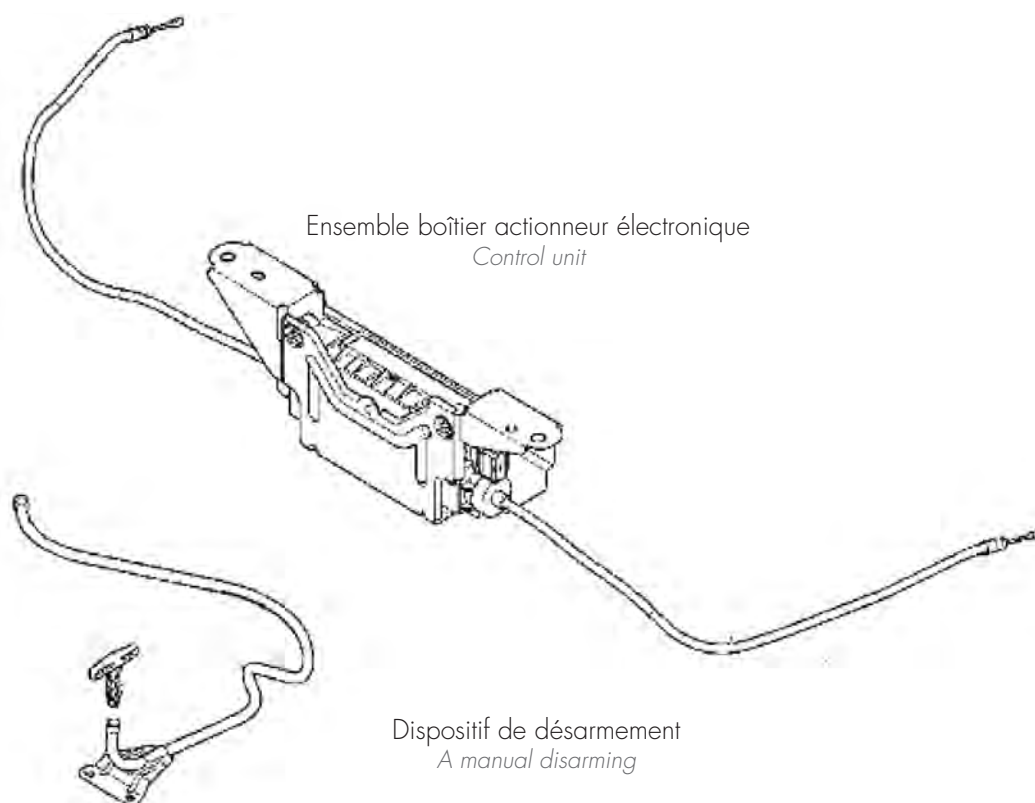

Les freins automatiques ou électriques plutôt réservés aux véhicules haut de gamme ont tendance aujourd'hui à se démocratiser sur tous les véhicules de moyenne gamme. Le principe de freinage reste identique, le frein à main est simplement remplacé par un boîtier actionneur électronique situé généralement à l'arrière du véhicule. Un dispositif de désarmement manuel d'urgence est tout de même conservé en cas de défaillance du boîtier électronique. Sur certains véhicules il est possible de changer uniquement les câbles sans changer l'ensemble câble et boîtier électronique. Les références OE utilisées dans notre catalogue correspondent aux références de l'ensemble boîtier. Dans les réseaux constructeurs les câbles utilisés pour les freins de parking automatiques ne sont pas vendus au détail.

Automatic or electric brakes rather reserved for premium vehicles today tend to democratize all mid-range vehicles. The principle remains the same braking; the handbrake is simply replaced by an electronic control unit located generally at the rear of the vehicle. A device for emergency manual disarming is still preserved in the event of failure of the control unit. In some vehicles it is possible to change only the cables without changing the control unit assembly. OE used in this catalog corresponds to the OE control unit. In manufacturer networks, cables used for a car who is equipped by automatic brakes is not sold at retail.

Les n° OPR et n° DAM

SA key help to identify the right part: OPR & DAM id number

DAM : Date d'Application de Modification / *Date of Application Change*

Les N° DAM et OPR sont des repères utilisés par les constructeurs pour connaître la date et le lieu de fabrication d'un véhicule. Ils servent, entre autres, à identifier les pièces de rechange qui correspondent au véhicule.

Le N° OPR est une référence avec 7 caractères qui peut se trouver dans la portière de votre voiture, dans le coffre ou sous le capot (sur la sphère d'amortisseur ou à la base du pare brise). Il contient le n° DAM, les 5 premiers chiffres, suivi de 2 chiffres ou lettres qui correspondent au code usine.

The serial number is a unique code assigned for identification of the place and the date of the vehicle's production. According to these numbers, one can easily identify the right parts which fit to the vehicle. The serial number normally features 7 alphanumeric codes and it can be found on the door panel, alternatively on the trunk panel or under the bonnet (on the shock absorber spring or at the windshield bottom). The first 5 digits are the Modification Application Date and the following 2 numerals or letters identify the factory's place.



Ici le N° **08524FV**
 here **08524FV** code

08524

Indique la date de production
 Features the production date.

FV

Indique le lieu de production
 Features the production place.

Attention : Le n° OPR correspond à la date de fabrication du véhicule et non à la date de 1^{ère} mise en circulation. En effet, il se peut qu'il y ait plusieurs mois de différence, voire une année en fonction du stock des parcs de véhicules. Pour les produits munis d'un n° OPR les dates mentionnées dans notre catalogue correspondent aux dates de fabrication et non aux dates de mise en circulation.

Reminder : This serial number features the production date only and not the initial entry into service date. It may have several months of difference or even a year between these 2 dates. In the next pages and as explained above, whenever an OPR number is shown, please take into account that it mentions the production date.

Les n°PR, n° de châssis et code moteur AUDI, SEAT, SKODA, VW

A key help to identify the right part: AUDI, SEAT, SKODA, VW PR id number, serial number & motor id

Les N° PR, les numéros de châssis et les codes moteur sont des repères utilisés par **AUDI, SEAT, SKODA et VW** pour identifier, de façon fiable, les pièces de rechange qui correspondent au véhicule. Le n° PR et le n° de code moteur sont des références à 3 caractères par contre le n° de châssis est composé de 8 caractères. Toutes ces références sont imprimées sur une étiquette collée dans le coffre et dans le carnet d'entretien de votre voiture.

The PR code, engine code and also the serial number are an unique code assigned by **AUDI, SEAT, SKODA and VW** for identifying the right parts which fit with the vehicle. PR code and also engine code normally feature 3 or 4 alphanumeric codes contrariwise the serial number normally features 8 alphanumeric codes and it can be found on you boot, alternatively in you maintenance booklet.

FAHRZG-IDENT-NR.			
VEHICLE-IDENT-NO.	WVWZZZ	1J z	2B064549
TYP/TYPE	1J10 E4		
	GOLF 1,6	BASIS	
MOTORK. / GETR.KB	77	5-G	
ENG.CODE / TRANS .CODE	AZD	ERT	
LAKE NR. / INNENAUSST.			
PAINT NO. / INTERIOR	LC6X	----	----
	2A0	B0C	C6D G0C H1T 1JL D3H Q1A
	—	1AC —	1MP 1NC 5RQ 5SL T27
		OBC —	3V1 QG1 0G3 — 8GD 8L3
		—	— 1KK 1LQ — — G27 0GG —
		—	— 4VE 4X1 4R4 4F1 N4C 5MA
	1JA	L17	OYZ — — — — —

- N° de châssis
Chassis code
- Code moteur
Engine code
- N°PR freinage AR
Rear brake id number

Liste code PR / PR code list

- 1KA** : Frein arrière à tambours / *Rear drum brake*
- 1KD** : Frein arrière à disques / *Rear disc brake*
- 1KE** : Frein arrière à disques / *Rear disc brake*
- 1KF** : Frein arrière à disques / *Rear disc brake*
- 1KK** : Frein arrière à disques / *Rear disc brake*
- 1KW** : Frein arrière à disques / *Rear disc brake*
- 1KT** : Frein arrière à disques / *Rear disc brake*

2014-2015

Câbles d'accélérateur



Accelerator cables
Cavi acceleratore
Mando de acelerador
Gasseile

Sommaire Contents

AUDI	13
CITROËN	13
DACIA	14
FIAT	14
FORD	15
IVECO	16
LADA	16
LANCIA	16
NISSAN	16
OPEL	17
PEUGEOT	17
RENAULT	18
SEAT	20
SKODA	20
SUZUKI	21
TALBOT	21
TOYOTA	21
VOLKSWAGEN	21

Comment utiliser l'onglet câble d'accélérateur ?

How to use accelerator cable tab ?

Véhicule Vehicle	Année Year	SEIM P/n	Kit P/n	Longueur Length	OE
RENAULT Suite...					
R4					
R4 Type R1120	Orig>	084070	KIT	1700/770	855675800
R4 type R1123	> 07/83	084070	KIT	1700/770	7701349843-7701349844
R4 Type R1126-R2109-R2392-R2430	Orig>	084070	KIT	1700/770	7701349843-7701349844
R4 Type R1128 jusqu'à n° de série 461100	Orig > 07/83	084070	KIT	1700/770	7701349843-7701349844
R4 Type R1128 depuis n° de série 461101	08/83 >	081720	084070	1000/550	7701349814-7700755027
R4 Type R2106	07/84 >	081720	084070	1000/550	7701349814-7700755027
R4 type R2370 210B & 239B	> 07/83	084070	KIT	1700/770	7701349843-7701349844
R4 Type R2370 210B & 239B	07/83 >	081720	084070	1000/550	7701349814-7700755027
R4 Type R2391 jusqu'à n° de série 9430	Orig> 07/83	084070	KIT	1700/770	7701349843-7701349844
R4 Type R2391 depuis n° de série 9431	08/83 >	081720	084070	1000/550	7701349814-7700755027
R4 fourg F4 (R1120 R1123 R1180 R1181)	08/84 >	062150	084070	1700/770	7700755025
R4 fourg F6	Orig > 07/83	033030	084070	1700/770	48617-7700625845
R4 all model	Orig>	084070	KIT	1700/770	Toutes
R5					
R5 all model sauf/except Alpine turbo & Turbo II	01/74 > 06/86	052150		1020/630	7704002453
R5 Alpine & Alpine turbo	01/74 > 06/86	082310	KIT	-	6001001468
R9 & R11					
R9 & R11 all model ESSENCE	07/81 > 07/85	084320	KIT	-	7701349422-7704001509 7704001513
R9 & R11 all model DIESEL	07/81 > 07/85	084340	KIT	-	7704001782
R9 & R11 all model	07/85 > 06/89	082310	KIT	-	7701349815
R14					
R14					
R18					
R18 & FUEGO Diesel all model					
R18 & FUEGO GTS-TS-Amercain	04/78 > 12/87	054460		660/429	7700641399
R18 & FUEGO L-TL-GTL	04/78 > 12/87	Not available		750/509	7700641401
R18 & FUEGO all model	04/78 > 07/85	Not available	KIT	-	7701348894
R18 & FUEGO TX GTX TD GTD	07/85 > 12/87	082310	KIT	-	7701349815
R19					
R19 & CHAMADE TR TD GTD TDE sauf/except Turbo	07/89 > 04/97	082310	KIT	-	7701349815
R20 TD-GTD-Turbo diesel	12/79 > 12/84	084340	KIT	-	7704001882
R21					
R21 TL GTL	01/86 > 06/89	062045	084330	580/440	7700765884
R21 TD GTD SD GSD TURBO D DX	01/86 > 12/95	062047	084330	830/710	7700765883
R21 all model sauf/except TXI & 2.0 Turbo	01/86 > 07/86	084330	KIT	-	7700799257
R21 all model sauf/except TXI & 2.0 Turbo	07/86 > 12/95	082310	KIT	-	7701349815
		084330	KIT	-	7700799257
		Not available		1150/930	7700798013
R25 GTS-TS-GTX	03/84 > 06/92	062042		1220/910	7700759758
		064100		1220/910	7700767945

 Modèle
 Model

 Date de fabrication
 Date of manufacture

 Référence Seim
 Seim P/n

 Longueur en mm :
 Câble/Gaine
 Length in mm
 Cable/girdle

 Référence d'origine
 OE P/n

Toutes les références portant la mention « KIT » sont des kits d'accélérateur
All references marked "KIT" are kits accelerator

Référence du kit d'accélérateur :
 Le kit est composé de plusieurs composants permettant une adaptation à plusieurs véhicules ou motorisations.
Reference accelerator kit :
 The kit is composed of several components to enable an adaptation to car or engine.

Référence du câble d'accélérateur spécifique
Cable reference specific accelerator

**Pour toutes questions notre service technique est disponible
 du lundi au vendredi de 8H00 à 12H15 et de 13H15 à 17H00
 Tél. 04 74 46 07 36**

Véhicule Vehicle	Année Year	SEIM P/n	Kit P/n	Longueur Lenght	OE
AUDI					
A3					
A3 all model sauf/except 1.8 Turbo	09/96 -> 10/00	554614		1735/1455	1J0721555Q-1J0721555T
A3 1.8 Turbo	09/96 -> 10/00	554615		1262/980	1J0721555D-1J0721555M
A3 all model	09/96 -> 10/00	122107		1130/900	1J0721555T
CITROËN					
AX					
AX 954 - 1124 CC-SPORT	09/86 -> 06/98	084130	KIT	-	162986
AX Diesel	09/86 -> 06/98	081522		1130/990	96016641
AXEL					
AXEL	07/84 -> 06/90	084140	KIT	-	95495918
BX					
BX all model	10/82 -> 12/93	084390	KIT	-	1629G0
BERLINGO					
BERLINGO		084390	KIT	-	1629G0
C1					
C1 1.0	06/05 ->	554616		1325/1135	1629G4-781800H010
C2					
C2 all model	09/03 ->	084310	KIT	-	1629F9
C3					
C3 all model	09/02 ->	084310	KIT	-	1629F9
C5					
C5 all model	10/00 -> 04/08	084610		2500/2300	1629F8
C8					
C8 all model	06/02 ->	084310	KIT		1629F9
C15					
C15 Essence	10/84->06/96	084390	KIT	-	1629G0
C15 Diesel		084130	KIT	-	162986
C25					
C25 all model essence	09/81 -> 06/95	084410		1150/900	163091-4477021
C25 all model diesel	09/81 -> 06/95	084011		770/614	163090-5929979
C35					
C35 all model essence/gasoline	01/73 -> 12/91	084420		890/690	5436394
C35 all model 2.2 Diesel	01/73 -> 12/91	084430		1040/850	5441578
C35 all model 2.5 Diesel	01/73 -> 12/91	062210		1288/1098	5455064
CX					
CX all model	01/79 -> 12/89	084140	KIT	-	
EVASION					
EVASION all model	07/94 -> 07/02	084310	KIT	-	1629F9
GS & GSA					
GS & GSA all model	11/78 -> 07/86	084140	KIT	-	
JUMPER					
JUMPER all model	02/94 ->	122098	KIT	-	1629E6-1629G3
JUMPY					
JUMPY I all model	09/95 -> 01/07	084310	KIT		1629F9
SAXO					
SAXO all model	03/96 -> 12/04	084310	KIT	-	1629F9
VISA					
VISA Diesel	03/84 -> 06/88	061882		1000/890	95595357-9559535780
VISA all model essence/gasoline	07/82 -> 06/88	084390	KIT	-	1629G0
VISA 1.7D	09/78 -> 06/88	084130	KIT	-	162986
XANTIA					
XANTIA all model	05/93 -> 09/02	084390	KIT	-	1629G0

Véhicule Vehicle	Année Year	SEIM P/n	Kit P/n	Longueur Lenght	OE
CITROËN					
<i>Suite...</i>					
XM					
XM all model	07/89 -> 03/01	084310	KIT	-	1629F9
XSARA & XSARA PICASSO					
XSARA all model	07/97 -> 11/04	084390	KIT	-	1629G0
XSARA PICASSO all model	12/99 ->	084390	KIT	-	1629G0
ZX					
ZX all model	03/91 -> 06/98	084390	KIT	-	1629G0
DACIA					
LOGAN & LOGAN MCV					
LOGAN & LOGAN MCV all model	06/05 ->	122185		-	6001546868-8200215959
SANDERO					
SANDERO all model 1.4 1.6	06/08 ->	122185		-	6001546868-8200215959
FIAT					
BRAVA & BRAVO					
BRAVA / BRAVO 1.4 12V	09/94 -> 03/97	122109		590/440	46431041
BRAVA / BRAVO 1.4 12V	03/97 -> 12/01	Not available		810/670	46455149
BRAVA / BRAVO 1.6 16V	09/94 -> 12/01	122100		610/430	7776549
BRAVA / BRAVO 1.8 16V	09/94 -> 12/01	122132		1220/1055	46469068-46446692-7777632
BRAVA / BRAVO 2.0 20V	09/94 -> 12/01	122133		695/500	7772034
BRAVA / BRAVO 1.9 D	09/94 -> 12/01	084450		1050/860	7777663
BRAVA / BRAVO TD 75CV	09/94 -> 12/01	122134		910/730	46475311-46468658
BRAVA / BRAVO TD 100CV	09/94 -> 12/01	122135		705/520	46469731-46410902
CINQUECENTO					
CINQUECENTO all model	07/92 -> 09/98	554623		-	7749741-46406434
CROMA					
CROMA 2.5 Turbo D	01/91 -> 09/96	554617		1368/1138	82473850
CROMA Turbo ID	01/91 -> 09/96	554618		1190/959	82446865-82484339
DOBLO					
DOBLO all model 1.2	03/01 -> 01/10	700230		720/490	46796027
DUCATO					
DUCATO essence	09/81 -> 06/95	084410		1150/900	163091-4477021
DUCATO diesel	09/81 -> 06/95	084011		770/614	163090-5929979
DUCATO all model	02/94 ->	122098	KIT	-	1629E6-1629G3
MAREA					
MAREA all model 1.4	09/96 -> 03/97	122109		590/440	46431041
MAREA all model 1.4	03/97 -> 12/02	Not available		750/550	46463149
MAREA all model 1.5 & 1.6	09/96 -> 12/02	Not available		750/550	46463149
MAREA all model 1.8	09/96 -> 12/02	122132		1130/960	46446692
MAREA all model 1.9 TD	09/96 -> 12/02	122135		705/520	46469731-46410902
MULTIPLA					
MULTIPLA all model	01/99 -> 09/08	084460		710/530	46510552
PALIO					
PALIO & SIENA all model 1.2 & 1.6 16V	03/98 -> 12/02	084660		750/550	46419108
PALIO & SIENA all model 1.7TD	03/98 -> 12/02	084661		1110/920	46440558
PANDA					
PANDA FIRE 750 1000 4X4	03/86 -> 88	700150		850	7699907-7562094
PANDA FIRE 750 1000 4X4	88 -> 05/90	700220		950/720	7639374
PANDA FIRE 750 1000 4X4	06/90 ->	084672		1000/700	7699907
PANDA all model	88 -> 92	084671		1150/950	7702064
PANDA all model & 4X4	92 -> 08/03	554619		815/560	46783014
PANDA II 1.1 1.2	09/03 ->	554620		767/500	46800470-51733652-51739117

Véhicule Vehicle	Année Year	SEIM P/n	Kit P/n	Longueur Lenght	OE
FIAT					
PUNTO					
PUNTO 55-60-75 1.1 1.2 1.2L	11/93 -> 97	700200		830/700	7736507-7775116
PUNTO GT	11/93 ->	700201		720/560	7722083
PUNTO 55-60-75	97 -> 09/99	554621		880/718	7780024-7736507
PUNTO Diesel & Turbo Diesel	97 -> 09/99	700202		1090/920	7780028
PUNTO 85 1.2L 16V	97 -> 09/99	084682		690/530	46473223
PUNTO II 60	10/99 à 05/03	554622		808/631	46749873-46749874
PUNTO II 1.2 60-1.2 GNV	05/03 à 10/09	554622		808/631	46749873-46749874
PUNTO II 1.8L 16V	99 -> 09/99	084690		860/700	46540245
SCUDO					
SCUDO TT	De 09/95 à 10/07	084310	KIT		1629F9
SEICENTO					
SEICENTO 900	03/98 ->	554623		708/530	7749741
SEICENTO 900 avec/with ABS	03/98 ->	554624		670/540	46737306
SEICENTO 1100 SPORTING	03/98 ->	554625		805/529	46557485-46841644
SEICENTO 1100 SPORTING avec/with ABS	03/98 ->	554626		850/710	46737307
SEICENTO 1108 CC	03/98 ->	554627		833/663	46406434
TIPO & TEMPRA					
TIPO/TEMPRA 1.4 1.6	05/88 -> 02/96	700130		-	75993345
TIPO/TEMPRA D DT 2eme modele	05/88 -> 02/96	084661	KIT	-	7601050
TIPO/TEMPRA 1.8	05/88 -> 02/96	084734		-	7630757
ULYSSE					
ULYSSE all model	09/95 -> 09/02	084310	KIT		1629F9
UNO					
UNO 45 all model (mot FIRE)	05/85 -> 90	700180		1140/900	7556948
UNO 60-70 all model	05/85 -> 89	700030		1270/1011	7563347
UNO CS 1.1	87 ->	Not available		-	7665628
UNO 1.4D (1367cm3)	05/83 ->	084730		760/580	5970581
UNO 1.1ie	88 ->	084671		-	7620591
UNO 1.1 FIRE (1108 cm3)	06/90->	084672	KIT	-	7706323

FORD					
ESCORT & ORION					
ESCORT ORION all model Essence	08/90 ->	Not available		1500/1300	6630810
ESCORT ORION all model Diesel	86 ->	600411		1120/1020	6177044-1644531-86AB9C799CB
ESCORT ORION all model Diesel BOSCH	09/90 -> 95	122108		1780/1650	6596400
ESCORT ORION all model Diesel C.A.V	09/90 -> 95	122105		1710/1550	6624412
COURRIER (FIESTA)					
COURRIER (FIESTA)	10/96 ->03/00	084630		1158/954	1075712-1149532-1018293
FIESTA					
FIESTA 900 & 1.1	76 ->	600320		735/600	6048102-6107734-77FB9C799FB
FIESTA 1.1	06/89 ->	600330		960/810	6168454-89FB9C799CB
FIESTA 1.3	76 -> 83	Not available		1060/870	6049458-78FB9C799AA
FIESTA 1.3	83 -> 86	600410		920/720	6049459-78FB9C799BA
FIESTA 1.4	86 -> 89	Not available		1105/915	1640735-86FB9C799
FIESTA 1.4	06/89 ->	600340		1380/1255	6168458-89FB9C799HA
FIESTA 1.2 16V 1.4 16V	09/95 -> 09/99	Not available		-	1018880
FIESTA 1.8D	09/95 -> 09/99	122164		-	1018293 -1207867
FIESTA 1.8D	09/99 -> 09/02	084630		1158/954	1075712-1149532-1018293
FOCUS					
FOCUS 1.8 16V all model	10/98 -> 09/04	Not available	KIT	1860	1124279
GALAXY					
GALAXY all model sauf/except TDI	09/95 -> 08/00	122107		1130/900	7240132
SIERRA					
SIERRA 1.6 L	09/82 ->	600200		1110	1634278
SIERRA 2.0 2.3	10/82 ->	600412		695/555	1613178

Véhicule Vehicle	Année Year	SEIM P/n	Kit P/n	Longueur Lenght	OE
FORD					
<i>Suite...</i>					
SIERRA 1.8 (OHC)	87 -> 92	600413		1475/1350	6157360
SIERRA all model DIESEL	09/82 -> 87	600260		730/560	6130797
SIERRA all model DIESEL	87 ->	600350		627	6172325
TRANSIT					
TRANSIT all model Diesel	74 ->	Not available		1560/1410	7045221
TRANSIT all model Diesel	01/78 -> 83	600190		1175/1030	6109399
TRANSIT all model Essence	01/78 ->	Not available		1560/1410	7045221
TRANSIT all model	11/85 ->	554628		1323/1183	6152628-86VB9A758CA
TRANSIT 2.5D	11/85 ->	554629		1217/1015	6142769
IVECO					
DAILY					
DAILY I 30.8-35.8-40.8	91 ->	554630		1140/887	93813566
DAILY I 35.10-45.10-49.10	91 ->	554631		1078/897	93810251
LADA					
SAMARA & SAGONA					
SAMARA & SAGONA all model	86 ->	760010		1276	21081108054
LANCIA					
KAPPA					
KAPPA 2.0	12/94 ->	554632		835/580	60603127
LYBRA					
LYBRA 1.6	09/99 ->	554633		792/500	46524128
LYBRA 1.8	09/99 ->	Not available		1070/894	46764471
Y & YPSILON					
Y 1.2	97 ->	122137		860/696	46454010
Y 1.4	97 ->	122138		900/738	46430821
Y 1.4	97 ->	554635		800/610	46455495
Y all model	00 ->	554636		803/540	46742243
YPSILON 1.2	03 ->	554637		763/507	46813931
NISSAN					
ALMERA					
ALMERA I (N15) 1.4 & 1.6 all model	10/95 -> 03/00	710010		1344/1105	182011M200
ALMERA I (N15) 2.0D	10/95 -> 03/00	710011		1338/1160	182016QJ01
ALMERA II (N16) 1.5 1.8 & 2.2 VDI	03/00 -> 02/02	710012		-	18201BN000
ALMERA TINO	07/00 -> 04/03	710012		-	18201BN000
MICRA					
MICRA 1.0 - 1.3	10/92 -> 09/96	710000		1225	182015F200
PRIMERA					
PRIMERA 1.6 LX SIX	10/90 -> 09/96	710001		1285	1820199J02
PRIMERA 1.6 LX Kombi (break)	10/90 -> 09/96	710008		-	1820181N00
PRIMERA 2.0	10/90 -> 09/96	710002		1330	1820199J11
PRIMERA 2.0 SIX	10/90 -> 09/96	710003		1395	1820193J01
PRIMERA 2.0 GT	10/90 -> 09/96	710004		2040	1820194J01
PRIMERA 1.6 GX SIX	10/96 -> 09/99	710006		-	182012010-182012070
PRIMERA 2.0 GT SE SIX	10/96 -> 09/99	710007		-	182012F210-182012F270
PRIMERA 1.8 P	09/99 -> 03/02	710005		-	182019F610
SERENA					
SERENA	93 ->	710013		-	182019C600
SERENA 1.6	93 ->	710014		2240	182019C700

Véhicule Vehicle	Année Year	SEIM P/n	Kit P/n	Longueur Lenght	OE
NISSAN					
SUNNY					
SUNNY (N14) 2.0D	02/91 -> 12/95	710011		1338/1160	1820160J01
VANETTE					
VANETTE	87 ->	710015		2316	18201Y9504
VANETTE	87 ->	710016		2700	18201Y9600
VANETTE CARGO 1.6	87 ->	710004		2240	182019C700

OPEL					
ASTRA					
ASTRA TT	De 09/91 à 03/98	084350	Kit	1245/950	
ASTRA 1.2	04/98 -> 04/04	554638		671/403	847166-90530802
ASTRA 1.4 1.6 1.8 2.0 16V	04/98 -> 04/04	554639		602/362	847168-90530808
ASTRA 1.6 8V 75cv	04/98 -> 04/04	554640		795/565	847172-90530812
VECTRA A					
VECTRA A 1.7 D	07/92 -> 06/95	084350		1223/952	847007

PEUGEOT					
104					
104 all model	01/76 -> 06/88	084130	KIT	1714/1410	162986
106					
106 all model	09/91 -> 09/03	084310	KIT	1714/1410	1629F9
107					
107 1.0	06/05 ->	554616		1325/1135	1629G4-781800H010
204					
204 all model	65 -> 76	059040	KIT	-	163068
205					
205 only Diesel model	03/83 -> 12/98	061783		1000/920	162909
205 all model	03/83 -> 12/98	084130	KIT	1714/1410	162986
206					
206 all model	09/98 -> 09/02	084390	KIT	2677/2490	1629G0
304					
304 all model	09/69 -> 09/79	059040	KIT	-	163068
305					
305 1.6 GTGL-GR 1.9 GTX	07/77 -> 06/89	084130	KIT	1714/1410	162986
305 all model sauf/except GT GTX	07/77 -> 06/89	084100	KIT	1000/1620	163092
305 GT GTX	07/77 -> 06/89	059040		1365/1645	163068
306					
306 all model	02/93 -> 03/02	084390	KIT	2710/2500	1629G0
307					
307 all model	04/01 -> 06/08	084390	KIT	2710/2500	1629G0
309					
309 only diesel model	10/85 -> 12/93	061783		1000/920	162909
309 all model	10/85 -> 12/93	084130	KIT	1714/1410	162986
404					
404 all model	05/60 -> 10/75	059040	KIT	-	163068
405					
405 all model	07/87 -> 10/96	084130	KIT	1714/1410	162986
406					
406 all model		084390	KIT	2710/2500	1629G0
504					
504 all model sauf/except mot XD2	09/68 -> 96	059040	KIT	-	163068
505					
505 all model sauf/except diesel après 80	07/79 -> 92	059040	KIT	-	163068
605					
605 all model	09/89 -> 07/99	084310	KIT	-	1629F9

Véhicule Vehicle	Année Year	SEIM P/n	Kit P/n	Longueur Lenght	OE
PEUGEOT					
<i>Suite...</i>					
607					
607 all model	11/99 ->	084580	KIT	-	1629G1
806					
806	07/94 -> 09/02	084310	KIT	-	1629F9
EXPERT					
EXPERT TT	De 09/96 -> 10/10	084310	KIT	-	1629F9
BOXER					
BOXER all model	02/94 ->	122098	KIT	-	1629E6-1629G3
J5					
J5 all model diesel	10/81 -> 07/90	084011		770/614	163090-5929979
J5 all model essence	83 -> 06/94	084410	KIT	1150/900	163091-4477021
J7 & J9					
J7 & J9 all model	08/73 -> 06/86	Not available		-	
J7 & J9 all model	07/86 -> 91	084130	KIT	590/380	162986
PARTNER					
PARTNER (M49 & M59) all model	09/96 -> 10/10	084310	KIT	-	1629F9
RENAULT					
CLIO					
CLIO all model 1.4 & 1.4 BACARRA	06/90 -> 03/94	084092		1265/945	7700814767
CLIO 1.1 (1108cm3)	06/90 -> 03/94	084090		760/626	7700802684
CLIO 1.2 (mot E5F 1171cm3)	06/90 -> 03/94	084091	084330	1203	7700802693
CLIO 1.2 (mot E7F) & 1.4	06/90 -> 03/96	084093	084330	1305/884	7700813980
CLIO 1.4 (mot E7J)	03/96 -> 08/98	084093	084330	1305/884	7700813980
CLIO 1.7 1.8	06/90 -> 08/98	084330	KIT	-	7700814895
CLIO DIESEL	06/90 -> 08/98	084053	084330	955/765	7700831505-7700802692
CLIO all model	06/90 -> 08/98	084330	KIT	-	
CLIO II 1.2 16V & 2.0 16V	03/98 ->	084490	084330	690/460	7700427379-7700416622
CLIO II 1.4 & 1.6	03/98 ->	084330	KIT	-	
CLIO II 1.4 16V & 1.6 16V	03/98 ->	084510	084330	1400/1330	7700432309
CLIO II 1.9 Diesel 65cv	03/98 -> 06/01	084520	084330	1130/910	8200039054-7700425600 7700429400
CLIO II all model y compris/include 1.9DTI	03/98 ->	084330	KIT	-	8200700587-77004221527
ESPACE					
ESPACE Turbo D Turbo DX 2000-1D	07/84 -> 04/91	062041	084330	750/590	6025002332
ESPACE II 2.1dT	04/91 -> 02/95	062673	084340	790/660	6025171050-6025102239
ESPACE II 2.0i	03/95 -> 09/02	122149	084330	690/410	6025303659
ESPACE I II & III all model	03/95 -> 09/02	084330	KIT	-	6025314859-6025313729 6025314861-6025305224 6025316517-6025303227
KANGOO					
KANGOO 1.9 Diesel 65cv	03/97 -> 06/03	084520	084330	1130/910	8200039054-7700425600 7700429400
KANGOO all model	09/97 -> 12/07	084330	KIT	-	
LAGUNA					
LAGUNA & NEVADA 1.8	01/94 -> 11/00	084205	084330	1210/1000	7700824077
LAGUNA & NEVADA 2.2 dT	01/94 -> 11/00	084330	KIT	-	7700419415-7700824071
MASTER					
MASTER Essence	07/86 ->	082310	KIT	-	7701349815
MASTER 2.1DT-2.5 Diesel	10/97 -> 11/03	084530	084340	1510/1170	7700310777
MASTER 2.8 Turbo Di	05/89 -> 11/03	084540	084330	1315/995	7700302301
MEGANE & SCENIC					
MEGANE & SCENIC all model	11/95 -> 09/02	084330	KIT	-	
SCENIC 1.4 16V & 1.6 16V	11/95 -> 09/02	122123		1256x1076	7700415221
SCENIC 2.0 16V & 1.9DCI	11/95 -> 09/02	122153		610/430	7700437316

Véhicule Vehicle	Année Year	SEIM P/n	Kit P/n	Longueur Lenght	OE
RENAULT					
<i>Suite...</i>					
R4					
R4 Type R1120	Orig>	084070	KIT	1700/770	855675800
R4 type R1123	-> 07/83	084070	KIT	1700/770	7701349843-7701349844
R4 Type R1126-R2109-R2392-R2430	Orig>	084070	KIT	1700/770	7701349843-7701349844
R4 Type R1128 jusqu'à n° de série 461100	Orig > 07/83	084070	KIT	1700/770	7701349843-7701349844
R4 Type R1128 depuis n° de série 461101	08/83 ->	081720	084070	1000/550	7701349814-7700755027
R4 Type R2106	07/84 ->	081720	084070	1000/550	7701349814-7700755027
R4 Type R2370 210B & 239B	-> 07/83	084070	KIT	1700/770	7701349843-7701349844
R4 Type R2370 210B & 239B	08/83 ->	081720	084070	1000/550	7701349814-7700755027
R4 Type R2391 jusqu'à n° de série 9430	Orig> 07/83	084070	KIT	1700/770	7701349843-7701349844
R4 Type R2391 depuis n° de série 9431	08/83 ->	081720	084070	1000/550	7701349814-7700755027
R4 Type 112C & S128	Orig>	081720	084070	1000/550	7701349814-7700755027
R4 fourg F4 (R1120 R1123 R1126)	70 -> 74	011186	084070	793/403	7701348066
R4 fourg F4 (R1120 R1123 R1180 R1181)	75 -> 07/83	015790	084070	548/210	7701348381-7701348383
R4 fourg F4 (R1120 R1123 R1180 R1181)	08/84 ->	062150	084070	1095/685	7700755025
R4 fourg F6	Orig -> 07/83	033030	084070	920/510	7701348617-7700625845
R4 all model	Orig>	084070	KIT	1700/770	Toutes
R5					
R5 all model sauf/except Alpine Alpine turbo & Turbo II 01/74 -> 06/86		052150		1020/630	7704002453
R5 Alpine & Alpine turbo	01/74 -> 06/86	082310	KIT	-	6001001468
R9 & R11					
R9 & R11 all model ESSENCE	07/81 -> 07/85	084320	KIT	-	7701349422-7704001509 7704001513
R9 & R11 all model DIESEL	07/81 -> 07/85	084340	KIT	-	7704001782
R9 & R11 all model	07/85 -> 06/89	082310	KIT	-	7701349815
R14					
R14	07/79>06/83	056880	KIT	-	7701348890
R18					
R18 & FUEGO Diesel all model	07/80 -> 07/85	062670		900/720	7704002293
R18 & FUEGO GTS-TS-Amercain	04/78 -> 12/87	054460		660/429	7700641399
R18 & FUEGO L-TL-GTL	04/78 -> 12/87	Not available		750/509	7700641401
R18 & FUEGO all model	04/78 -> 07/85	Not available	KIT	-	7701348894
R18 & FUEGO TX GTX TD GTD	07/85 -> 12/87	082310	KIT	-	7701349815
R19					
R19 & CHAMADE TR TD GTD TDE sauf/except Turbo D07/89 -> 04/97		082310	KIT	-	7701349815
R19 & CHAMADE all model	07/89 -> 04/97	084330	KIT	-	7700787473-7700806995 7700792189-7700789191 7700792403-7700802870 7700812042-7700813980
R20					
R20 LS-TS-TX (1272, 1277, 1279)	11/75 -> 12/84	056880	KIT	-	7701348890
R20 TD-GTD-Turbo diesel	12/79 -> 12/84	084340	KIT	-	7704001882
R21					
R21 TL GTL	01/86 -> 06/89	062045	084330	580/440	7700765884
R21 TD GTD SD GSD TURBO D DX	01/86 -> 12/95	062047	084330	830/710	7700765883
R21 all model sauf/except TXI & 2.0 Turbo	01/86 -> 07/86	084330	KIT	-	7700799257
R21 all model sauf/except TXI & 2.0 Turbo	07/86 -> 12/95	082310	KIT	-	7701349815
R21 2.0 Turbo & R21 all model BV AUTO	07/86 -> 12/95	084330	KIT	-	7700799257
R21 TXI	05/92 -> 12/95	Not available		1150/930	7700798013
R25					
R25 Diesel (TD-GTD-Turbo D-Turbo DX)	03/84 -> 06/92	062042		1220/910	7700759758
R25 GTS-TS-GTX	03/84 -> 06/92	064100		1220/910	7700767945
R25 V6 INJ AUTO	03/84 -> 06/92	Not available		-	7700759761
R25 all model sauf/except V6	07/85 -> 06/92	082310	KIT	-	7701349815
R30					
R30 Turbo diesel	10/81 -> 12/83	084340		990/830	7704001882
R30 TS (1273 1275)	03/75 -> 12/83	056880	KIT	-	7701348890

Véhicule Vehicle	Année Year	SEIM P/n	Kit P/n	Longueur Lenght	OE
RENAULT					
<i>Suite...</i>					
SAFRANE					
SAFRANE all model	04/92 -> 08/00	084330	KIT	-	7700834531
SUPER CINQ & EXPRESS					
SUPER 5 & EXPRESS all model Diesel	09/84 -> 07/85	062040	084340	785/780	7704001782
SUPER 5 & EXPRESS all model Essence	09/84 -> 07/85	059852	084320	970/860	7701349422
SUPER 5 GT TURBO	09/84 -> 12/96	Not available			7700762380
SUPER 5 & EXPRESS all model	07/85 -> 07/91	082310	KIT	-	7701349815
SUPER 5 & EXPRESS all model	07/91 -> 12/96	084330	KIT	-	
TRAFIC					
TRAFIC all model Diesel (8140, moteur 2445 cm3)	09/80 ->	059852	084320	990/815	7700704805
TRAFIC all model Diesel (847, moteur 2068 cm3)	09/80 ->	062060	084320	1350/1188	7704002206
TRAFIC all model Essence mot 847	09/80 ->	059852	084320	900/710	7701349422
TRAFIC all model Essence & Diesel	07/85 -> 09/01	082310	KIT	-	7701349815
TWINGO					
TWINGO all model	04/93 -> 02/95	084210	084340	1270/1080	7700823051
TWINGO 1239 cm3	02/95 -> 08/98	084280	084330	1270/1080	7700847796
TWINGO all model	02/95 ->	084330	KIT	-	
SEAT					
ALHAMBRA					
ALHAMBRA all model sauf/except TDI	05/96 -> 07/00	122107		1130/900	
CORDOBA					
CORDOBA 1.6i & 1.8i	05/93 -> 10/02	122107		1130/900	1H0721555Q-6N1721555L
IBIZA					
IBIZA 1.2 & 1.7D	04/83 -> 05/93	720010		370/255	SE021110501C-X03949848
IBIZA Diesel	04/83 -> 05/93	720030		855/690	X039390870
IBIZA II all model sauf/except TDI	05/93 -> 09/99	122107		1130/900	1H0721555B-1H0721555Q 6K0721555B-6N1721555L
INCA					
INCA all model	01/96 -> 12/04	122107		1130/900	1H0721555Q-6N1721555L
LEON					
LEON 1.4i & 1.6i	02/00 ->	122107		1130/900	1J1721555N-1J0721555T
MALAGA					
MALAGA 1.2 & 1.7D	85 -> 12/92	720010		370/255	SE021110501C-X03949848
MALAGA Diesel	85 -> 12/92	720030		855/690	X039390870
MALAGA all model	85 -> 12/92	Not available	KIT	910	X03970398C
MALAGA all model	05/93 -> 02	122107		1130/900	
MARBELLA					
MARBELLA 0.9 1.3D & 1.4D	11/86 -> 12/98	122141		790	SE141110501A
RONDA					
RONDA 1.2 & 1.7D	82 -> 92	720010		370/255	SE021110501C-X03949848
RONDA Diesel	82 -> 92	720030		855/690	X039390870
RONDA all model	82 -> 92	Not available	KIT	910	X03970398C
RONDA all model		122107		1130/900	
TERRA					
TERRA 0.9 1.3D & 1.4D	86 ->	122141		790	SE141110501A
TOLEDO					
TOLEDO all model	07/91 -> 02/99	Not available		-	
TOLEDO II 1.6i	04/98 -> 09/04	122107		1130/900	1J0721555T
SKODA					
OCTAVIA					
OCTAVIA 1.6i	05/97 ->	122107		1130/900	1J0721555T
OCTAVIA 1.8i	91 ->	Not available		-	
FELICIA					
FELICIA all model	95 ->	Not available		-	

Véhicule Vehicle	Année Year	SEIM P/n	Kit P/n	Longueur Lenght	OE
SUZUKI					
SANTANA					
SANTANA SJ410	84 ->	731000		1265	15910A80011
SANTANA SJ413	85 ->	731001		1000	15910A83010
VITARA					
VITARA 1.6 all model	89 ->	731004		1007/853	1591085C20-1591085C30
TALBOT					
HORIZON					
HORIZON GL GLS Jubile S SPL (carbu double corps)	78 -> 86	Not available		1439/1213	57186700
HORIZON LS GL GLS EX (carbu simple corps)	78 -> 86	051611		1300/1144	13897300
SAMBA					
SAMBA all model	82 -> 86	084130	KIT	-	162986
TOYOTA					
AYGO					
AYGO 1.0	06/05 ->	554616		1325/1135	1629G4-781800H010
YARIS					
YARIS 1.0 1.3 Japanese model	04/99 -> 12/05	Not available		1223/1040	7818052050
YARIS 1.0 1.3 French model	04/99 -> 12/05	Not available		1223/1040	7818052010-7818052020
YARIS 1.0 French model	12/05 ->	554642		1295/1097	781800D010
YARIS 1.3 French model	12/05 ->	554643		1332/1145	781800D040
VOLKSWAGEN					
BORA					
BORA 1.4i & 1.6i	10/98 -> 12/05	122107		1130/900	1J1721555N-1J0721555T
GOLF					
GOLF GTI	77 ->	550100		1068/800	171721555T
GOLF II 1.1 1.3 1.5	10/83 -> 08/91	550100		1068/800	17172 555T
GOLF II GTI 1.6 1.8	10/83 -> 08/91	550380		600/790	191721555
GOLF I & II all model	-> 08/91	Not available		-	
GOLF III all model sauf/except TDI	01/92 ->	122107		1130/900	1H0721555Q-1H0721555R 1H0721555B-1H0721555D 1H0721555E
GOLF IV 1.4i & 1.6i	01/98 -> 05/04	122107		1130/900	1J1721555N-1J0721555T
NEW BEETLE					
NEW BEETLE all model	01/99 ->	084650	KIT	1200/1000	1J1721555K
PASSAT					
PASSAT 1.8	09/83 -> 88	Not available		892/585	321721555AA
PASSAT 1.6 1.8	88 ->	550380		600/790	191721555
SHARAN					
SHARAN all model sauf/except TDI	10/95 -> 06/00	122107		1130/900	7M1721555M-7M1723555D
TRANSPORTER					
TRANSPORTER Diesel	80 ->	550410		3945/1280	251721555C
TRANSPORTER 1.9 TDI	90 ->	550411		1230/1000	701721555K-701721555A
TRANSPORTER 2.0	96 ->	122144		1125/875	701721555J
VENTO					
VENTO all model sauf/except TDI	04/92 -> 12/97	122107		1130/900	1H0721555B-1H0721555D 1H0721555E



Lined area for notes with horizontal dotted lines.

Câbles de compteur



Speedometer cables
Transmissioni
Contachilometri
Mando cuenta

Sommaire Contents

CITROËN.....	25
FIAT	27
FORD.....	28
LADA	28
NISSAN	29
OPEL.....	29
PEUGEOT	29
RENAULT	31
SEAT	32
SUZUKI	32
TALBOT	33
VOLKSWAGEN	33
EMBOUT DE COMPTEUR SPEEDOMETER END FITTING	33

Comment utiliser l'onglet câble de compteur ?

How to use speedometer cable tab ?

Véhicule Vehicle	Type	Année Year	SEIM P/n	Longueur Lenght	OE
PEUGEOT Suite...					
305					
305 all model sauf/except GT-GTX		07/77 -> 07/82	500810	810 DJ	612283
305 all model sauf/except GT-GTX		07/82 -> 06/89	500800	800 DJ	612320
305 GT GTX		07/77 -> 06/89	501020	1020 CP	612374
306					
306 all model		> 96	500896	900 CL	6123H3-9621631180
309					
309 all model sauf/except GTI & GTI 16S		10/85 -> 12/93	500892	890 CJ	6123C4-612379
309 all model sauf/except GTI & GTI 16S		10/85 -> 12/93	500902	890 CP	6123C4-612379
309 GTI & GTI 16S		10/85 -> 12/93	500871	870 CJ	6123C3
405					
405 all model essence/gasoline sauf/except 4x4 & Taxi		07/87 -> 06/92	500892		
405 all model essence/gasoline sauf/except 4x4 & Taxi		07/87 -> 06/92	500902		
405 all model Diesel sauf/except Taxi			500971		
405 all model 4x4			Not available		
405 all model sauf/except 4x4 & Taxi			500943		
405 4x4 all model sauf/except Turbo 16			Not available		
405 Turbo 16		07/92 -> 10/96	500913	910 CL	6123H8-6123F2
504					
504 GL		09/68 -> 09/76	501811	1810 AG	612238
504 GL		09/68 -> 79	501810	1810 DG	612270
504 L GR SR		10/83 ->	501813	1810 DJ	612350
505					
505 all model 4 vitesses/4 speed sauf/except TI GTI STI & Turbo i		07/79 -> 06/83	501321	1620 DI 3	612316-612291-7920076423
505 all model 4 vitesses/4 speed sauf/except TI GTI STI & Turbo i		07/83 -> 92	501326	1620 DI 2,6	612348
505 all model 5 vitesses/5 speed sauf/except TI GTI STI & Turbo i		07/79 -> 06/83	501340	1340 DI 3	612314
505 all model 5 vitesses/5 speed sauf/except TI GTI STI & Turbo i		07/83 -> 92	501942	1940 DI 2,6	612346
505 all model TI GTI STI & Turbo i			Not available		
605					
605 all model sauf/except Taxi			500972	970 CL	6123F4-9616683680
806					
806 version emboîté/followed suit version	Version emboîté Followed suit version	07/94 -> OPR 06778 (05/95)	501120	1120 CN	6123H0
806 version clipsée/clipped version	Version clippé Clipped version	OPR 06778 (06/95) > 07/02	554654	1120CJ	6123L1-9618182680
BOXER					
BOXER 1000 & 1400 kg sans compteur /without tachometer boîte/gear box MLGU & ML5T	Encliquetable Click-fit coupling	Sérial n° 15106790 (02/94) >	501510	1513 CM	6123K6-6123L3-6123G6 1306982080-1315809080
BOXER 1800 kg sans compteur /without tachometer	Encliquetable Click-fit coupling	02/94 ->	501400	1420 JC	6123K7
BOXER sans compteur /without tachometer boîte/gear box MEST	Vissé Screw-on coupling	02/94 ->	501530	1530 KM	6123K2-6123G8
BOXER sans compteur /without tachometer boîte/gear box MG5T	Vissé Screw-on coupling	02/94 ->	501534	1420 KM	6123K3-1315807080
EXPERT					
EXPERT all model	Version emboîté Followed suit version	09/95 -> OPR 08210 (05/99)	501120	1120 CN	6123H0

Date de fabrication
Date of manufacture

760=Longueur du câble en mm
DB= Types d'embouts voir page 33
760=Lenght in mm
DB= Fitting type see page 33

Modèle
Model

Référence Seim
Seim P/n

Référence d'origine
OE P/n

**Pour toutes questions notre service technique est disponible
du lundi au vendredi de 8H00 à 12H15 et de 13H15 à 17H00
Tél. 04 74 46 07 36**

Véhicule Vehicle	Type	Année Year	SEIM P/n	Longueur Length	OE
CITROËN					
2CV					
2 CV4 AK - AZ		63 ->	500790	790 DB	95493346-5491160
2 CV Berline		Orig -> 06/79	500900	900 DB	AZ52139-95495507
2 CV6 all model		06/79 ->	500761	760 DB	AK5213B-5444200
AX					
AX all model sauf/except 1.4 GT, SPORT & Diesel	Côté Compteur Counter side	09/86->OPR 05284 (04/91)	500550	550 HP	95630473-9563047380
AX SPORT	Côté Compteur Counter side	09/86 ->OPR 05284 (04/91)	500410	620 HP	95638113-9563811380
AX 1.4 GT & Diesel	Côté Compteur Counter side	09/86 ->OPR 05284 (04/91)	500580	580 HJ	96002885
AX all model	Côté Boîte Gear box side	09/86 ->OPR 04724 (10/89)	500300	300 CB	95630472
AX all model	Côté Boîte Gear box side	OPR 04725 (10/89)-> 05285 (05/91)	500301	300 CB	6123G9-96089902 96139395-9608980280
AX all model	Côté Compteur Counter side	OPR 05285 (05/91)-> 05317 (06/91)	500302	300 HJ	96090652-9609065280
AX all model	Côté Boîte Gear box side	OPR 05285 (05/91)-> 05317 (06/91)	500621	620 CB	96073712
AX all model	Côté Compteur Counter side	OPR 05318 (06/91)-> 06175 (10/93)	500582	490 HM	96144885
AX all model	Côté Boîte Gear box side	OPR 05318 (06/91)-> 06175 (10/93)	500450	460 CG	96073325-9607332580
AX all model	Monobloc	OPR 06175 (10/93)->06/98	500892	890 CJ	6123G2-9613856680-6123C4
BX					
BX all model	Côté Compteur Counter side	10/82 -> 07/86	500550	550 HP	95630473-9563047380 75513020
BX all model sauf/except 4X4	Côté Compteur Counter side	07/86 -> 06/94	500410	620 HP	95600677-95638113 9563811380
BX all model 4X4 sauf/except 16S	Côté Compteur Counter side	07/86 -> 06/94	Not available	800	96043276
BX14 all model	Côté Boîte Gear box side	10/82 ->OPR 4252 (06/88)	500540	540 DG	95583772-95495845 95496540
BX14 all model	Côté Boîte Gear box side	OPR 4253 (06/88)->10/89	500450	450 CG	95566607
BX16 & 19D	Côté Boîte Gear box side	10/82 ->OPR 4252 (07/86)	500430	430 CG	95494967-95496541
BX16 & 19D	Côté Boîte Gear box side	OPR 4252 (07/86) -> OPR 4724 10/89	500450	450 CG	95566607
BX all model (sauf/except 4x4 16S & SPORT)	Côté Boîte Gear box side	OPR 4725 (10/89) ->06/94	500301	300 CB	96089902-96139395-6123G9 9608980280
BX 16S & SPORT	Côté Boîte Gear box side	10/82 -> 06/94	500260	580 CG	95496555
C15					
C15 all model	Côté Compteur Counter side	10/84 -> 12/05	500550	550 HP	75513020-75491950
C15 all model essence	Côté Boîte Gear box side	10/84->OPR 03978 (09/87)	500925	920 BD	95592655-9559265580
C15 all model essence	Côté Boîte Gear box side	OPR 03979 (10/87)-> OPR 04832 (01/90)	500450	450 CG	96073325-9607332580 95566607
C15 all model essence	Côté Boîte Gear box side	OPR 04833 (02/90) ->12/05	500301	300 CB	96089902-96139395 6123G9-9608980280
C15 Diesel	Côté Boîte Gear box side	10/84 -> 12/05	500620	620 CG	95496646-9549664680

Véhicule Vehicle	Type	Année Year	SEIM P/n	Longueur Lenght	OE
CITROËN Suite...					
C25					
C25 all model		09/81 -> 91	501240	1240 AM	6123E1-7666874-612399
C25 all model		91 -> 06/93	500990	1350 AM	6123C7-7745213-7666874
C25 all model		07/93 -> 06/95	501360	1350 KM	6123G4-7780909
C25 all model avec compte-tour/with tachometer		09/81 -> 06/95	Not available	1020 JG	6123K1-95598433
C25 all model avec compte-tour/with tachometer		09/81 -> 06/95	Not available	630 AG	6123J6
C32 & C35					
C32-C35 all model sans compte-tour/ without tachometer	Côté Compteur Counter side	01/73 -> 10/83	501860	1860 HG	5444201
C32-C35 all model sans compte-tour/ without tachometer	Côté Boîte Gear box side	01/73 -> 10/83	500761	760 BD	5444200
C32-C35 all model sans compte-tour/ without tachometer	Côté Compteur Counter side	10 83 -> 12/91	Not available	1890 JH	95595611
C32-C35 all model sans compte-tour/ without tachometer	Côté Boîte Gear box side	10 83 -> 12/91	500900	900 BD	95495507-AZ52139
C35 all model avec compte-tour/with tachometer	Côté Compteur Counter side	01/73 -> 12/91	Not available	1020 JG	6123K1-95598433
C35 all model avec compte-tour/with tachometer	Côté Boîte Gear box side	01/73 -> 12/91	Not available	1770 AG	95596431
CX					
CX all model 4 vitesses/4 speed	Côté Compteur Counter side	01/79 -> 12/89	500550	550 HP	5490132-95630473 9563047380-75513020
CX all model 4 vitesses/4 speed	Côté Boîte Gear box side	01/79 -> 12/89	500700	690 DG	95494965-76491654
CX all model 5 vitesses/5 speed	Côté Boîte Gear box side	01/79 -> 12/89	500970	970 AG	75491627
DYANE & ACADIANE					
DYANE & ACADIANE all model		09/68 -> 12/83	500700	690 DG	94494965
EVASION					
EVASION all model	Version emboîté Followed suit version	07/94 -> OPR 06778 (05/95)	501120	1120 CN	6123H0
EVASION all model	Version clippé Clipped version	OPR 06778 (06/95)-> 07/02	554654	1120CJ	6123L1
JUMPER					
JUMPER 1000 & 1400 kg sans compte-tour/ without tachometer boîte/Gear box MLGU & MLST	Encliquetable Clickfit coupling	série 15106790 (02/94) ->	501510	1513 CM	6123K6-6123L3-6123G6 1306982080-1315809080
JUMPER 1800 kg sans compte-tour/ without tachometer	Encliquetable Clickfit coupling	02/94 ->	501400	1420 JC	6123K7
JUMPER sans compte-tour/ without tachometer boîte/gear box ME5T	Vissé Screwon coupling	02/94 ->	501530	1530 KM	6123K2-6123G8
JUMPER sans compte-tour/ without tachometer boîte/gear box MG5T	Vissé Screwon coupling	02/94 ->	501534	1420 KM	6123K3-1315807080
JUMPY					
JUMPY all model	Version emboîté Followed suit version	09/95 -> OPR 08210 (05/99)	501120	1120 CN	6123H0
JUMPY all model	Version clippé Clipped version	OPR 08210 (05/99) -> 12/03	554654	1120CJ	6123L1
LN & LNA					
LN & LNA (mot 652cm3)		76 -> 07/82	500790	800 AG	95493346-5491160
LN & LNA (mot 652cm3)		07/82 -> 86	500230	230 HG	5491577
LN & LNA (mot 1124 cm3)		76 -> 06/83	500910	900 DB	612242
LN & LNA (mot 1124 cm3)		06/83 -> 86	Not available	910 DB	92523455
VISA					
VISA all model	Côté Compteur Counter side	09/78 -> 06/88	500550	550 HP	95630473-9563047380 75513020-5490132
VISA Spécial & Club	Côté Boîte Gear box side	09/78 -> 02/80	500790	790 DB	95493346-5491160

Véhicule Vehicle	Type	Année Year	SEIM P/n	Longueur Length	OE
CITROËN Suite...					
VISA Spécial & Club	Côté Boîte Gear box side	02/80 -> 06/88	500870	870 DB	75531334
VISA Super E.L.X 14TRS GT & Chrono	Côté Boîte Gear box side	09/78 -> 02/80	500910	900 DB	95494991
VISA Super E.L.X 14TRS GT & Chrono	Côté Boîte Gear box side	02/80 -> 06/88	500925	920 DB	95496500-95592655 -9559265580
VISA GTI & diesel	Côté Boîte Gear box side	02/80 -> 06/88	500620	620 CG	95496646-9549664680
XANTIA					
XANTIA all model		05/93 -> 09/02	500462	870 CL	96163009
XM					
XM all model sauf/except 3.0i & TD	Côté Compteur Counter side	07/89 -> OPR 05803 (09/92)	500470	470 HM	96041751
XM all model sauf/except 3.0i & TD	Côté Compteur Counter side	OPR 05804 (09/92) -> 03/01	Not available		6113Y4
XM 3.0i & 2.1 & 2.5TD	Côté Compteur Counter side	07/89 -> OPR 04837 (02/90)	500470	470 HM	96041751
XM 2.1 & 2.5TD	Côté Compteur Counter side	OPR 04838 (02/90) -> OPR 05803 (09/92)	500461	460 JB	96102827
XM 2.1 & 2.5TD	Côté Compteur Counter side	OPR 05803 (09/92) ->	Not available		6113Y3
XM 3.0i	Côté Compteur Counter side	OPR 04838 (02/90) -> OPR 05719 (07/92)	500461	460 JB	96102827
XM 3.0i	Côté Compteur Counter side	OPR 05719 (07/92) -> 03/01	Not available		6113Y3
XM all model sauf/except 2.0i & 2.0i Turbo	Côté Boîte Gear box side	07/89 -> 03/01	500450	460 CG	95492738-96073325 -9607332580
XM 2.0i & 2.0i Turbo	Côté Boîte Gear box side	07/89 -> 03/01	500451	460 CG	95566607-96166554
ZX					
ZX all model REFLEX	Côté Compteur Counter side	03/91 -> OPR 06747 (04/95)	500580	580 HJ	96074005-96002885-96147546
ZX all model REFLEX	Côté Boîte Gear box side	03/91 -> OPR 06747 (04/95)	500390	390 BC	96128130-9612813080
ZX all model sauf/except REFLEX	Côté Compteur Counter side	03/91 -> OPR 05347 (06/91)	500580	580 HJ	96074005-96002885-96147546
ZX all model sauf/except REFLEX	Côté Compteur Counter side	OPR 05348 (07/91) -> 04/95	500601	600 JH	96147546
ZX all model (essence/gasoline) sauf/ except REFLEX	Côté Boîte Gear box side	03/91 -> 04/95	500390	390 BC	96128130-9612813080
ZX all model (diesel) sauf/except REFLEX	Côté Boîte Gear box side	03/91 -> 04/95	500561	560 GC	96142943
FIAT					
CINQUECENTO					
CINQUECENTO (900cm3)	Côté Compteur Counter side	07/92 -> 03/94	505322	410	7698255-7791441
CINQUECENTO (900cm3)	Côté Boîte Gear box side	07/92 -> 03/94	505323	610 L1 K1	7698252-7798137
CROMA					
CROMA all model		05/86 -> 09/96	505150	1290 J1 P1	82382699
DUCATO					
DUCATO 1000 & 1400 kg sans compteur/ without tachometer boîte/gear box MLGU & MLST	Encliquetable Clickfit coupling	seria n°: 15106790 (02/94) ->	501510	1513 CM	1306982080-1315809080 1315808080-6123K6-6123L3 6123G6

Véhicule Vehicle	Type	Année Year	SEIM P/n	Longueur Length	OE
FIAT Suite...					
DUCATO 1800 kg sans compte-tour/ without tachometer	Encliquetable Click-fit coupling	02/94 ->	501400	1420 JC	6123K7
DUCATO (sans compte-tour/ without tachometer boîte/gear box ME5T	Vissé Screw-on coupling	02/94 ->	501530	1530 KM	6123K2-6123G8
DUCATO (sans compte-tour/ without tachometer boîte/gear box MG5T	Vissé Screw-on coupling	02/94 ->	501534	1420 KM	1315807080-6123K3
PALIO & SIENA					
PALIO & SIENA all model		03/98 -> 12/02	505327	930 J1 K1	46401201
PANDA					
PANDA all model		-> 03/88	505070	930 K1 L1	4413859
PANDA all model		03/88 -> 08/03	505290	910 J2 K1	7635491
SCUDO					
SCUDO all model	Version emboîté Followed suit version	09/95 -> OPR 08210 (05/99)	501120	1120 CN	6123H0
SCUDO all model	Version clippé Clipped version	OPR 08210 (05/99) -> 12/03	554654	1120 CJ	6123L1
TIPO & TEMPRA					
TIPO/TEMPRA all model sauf compteur digital/ except digital counter	Côté Boîte Gear box side	05/88 -> 02/96	505110	446 O1 J1	7648188-7602006-7679524
TIPO/TEMPRA all model sauf compteur digital/ except digital counter	Côté Compteur Counter side	05/88 -> 02/96	505270	469 E2 K1	7601995
TIPO/TEMPRA all model sauf compteur digital/ except digital counter		05/88 -> 02/96	505271	1010 O1 J1	7601995-7648188-7602006
ULYSSE					
ULYSSE all model	Version emboîté Followed suit version	07/94 -> OPR 06778 (05/95)	501120	1120 CN	6123H0
ULYSSE all model	Version clippé Clipped version	OPR 06778 (06/95) -> 07/02	554654	1120 CJ	6123L1
UNO					
UNO all model sauf/except Turbo ie		83 -> 10/95	505080	930 K1 J1	7635495
FORD					
ESCORT & ORION					
ESCORT ORION		80 -> 86	505060	1000 K1 L1	1591745
ESCORT ORION all model sans ord de bord/ without on-board computer		86 -> 91	505334	860 M1 L1	6159444
ESCORT ORION all model avec ord de bord/ without on-board computer		86 -> 91	505335	790 M1 J1	6159446
ESCORT ORION all model		91 ->	505340	1195 L1 M1	6483328
FIESTA					
FIESTA all model		06/83 -> 03/89	505050	990 I1 J1	6135499
FIESTA all model		04/89 ->	505341	850 I1 J1	6163213
SCORPIO					
SCORPIO			Not available	850 J2 W1	
SIERRA					
SIERRA all model 4 vitesses/4 speed		09/82 ->	505331	2700 G2 N1	6115152
SIERRA all model 5 vitesses/5 speed		87 ->	505100	2850 M1 N1	6151483
TRANSIT					
TRANSIT all model		88 -> 92	505333	2400 J1 M1	6156796
TRANSIT all model		92 -> 95	Not available	2500 B2 I2	6934504
TRANSIT all model		95 -> 00	Not available	2450 H2 I2	1050879
LADA					
NIVA					
NIVA		76 ->	505170	1180 L1 D3	21213819010
NEW NIVA			Not available		212213819010

Véhicule Vehicle	Type	Année Year	SEIM P/n	Longueur Length	OE
NISSAN					
MICRA					
MICRA (K11) all model 1.0-1.3-1.5D		10/92 -> 12/02	504404	869 A1 C1	2505054B65
MICRA (K12) all model 1.0-1.3-1.5D		01/03 ->	Not available	1900	65621AX10

OPEL					
ASTRA					
ASTRA 1.4-1.6-1.7D		89 ->	505190	850J1 Q1	1268282
ASTRA 1.4-1.6-1.7D		91 -> 96	505321	860J2 W1	1268335
ASTRA 2.0-1.7 DTS		92 -> 03/98	505300	860 Q1 G1	1268332-1268091
CORSA					
CORSA (A) 1.1-1.2-1.3		-> 02/93	505040	830 G1 C1	1268030
CORSA (A) 1.0-1.2S-1.3S-1.4S-1.5 D & TD		-> 06/90	Not available	950J2 D2	1268043
CORSA (A) 1.2-1.4 & 1.5D		06/90 -> 02/93	505324	750J2 W1	1268041
CORSA (B) 1.4-1.6 1.5TD		03/93 -> 04/97	505325	860 A2 Y1	1268324
CORSA (B) 1.4NZ auto		03/93 -> 04/97	505040	830 G1 C1	1268030
CORSA (B) 1.2-1.4-1.5D 1.7D		03/93 -> 04/97	505300	860 Q1 G1	1268332-1268091
KADETT					
KADETT (E)		07/84 -> 10/91	505260	920J1 Q1	1268055
TIGRA					
TIGRA 1.2-1.4 & 1.6		09/94 -> 09/00	505336	1120 A2 J1	1268415
VECTRA					
VECTRA 1.4-1.6-1.7D		09/88 -> 06/92	505190	860J1 Q1	1268282
VECTRA 1.4-1.6 1.7D		07/92 -> 06/95	505321	880J2 W1	1268213-1268306-1268335
VECTRA 1.8-2.0 & 1.7TD		07/92 -> 06/95	505300	860 Q1 G1	1268332-1268091

PEUGEOT					
104					
104 all model diam:3.15x2.96		01/76 -> 07/80	500910	910 DB	612214-612215-612245
104 all model diam:3.6x4.11		07/80 -> 07/85	500901	900 DJ	612324-612296
104 all model		07/85 ->	500942	940 DJ	612373
106					
106 all model		09/91 -> 23/03/93	500892	890 CJ	6123C4-9608052980-6123G2 9613856680
106 all model		24/03/93 -> 04/96	500902	890 CP	6123J4-9622560780
205					
205 1.0 1.1 1.1i 1.3 rallye 1.4 & 1.4i boîte/ gear box BH3	Avec ressort With spring	03/83 -> 07/88	554766	930 DI	612387-9753607280
205 1.0 1.1 1.1i 1.3 rallye 1.4 & 1.4i boîte/ gear box BH3		08/88 -> 06/90	500891	890 DP	612392
205 1.6 1.6 GTI 1.9 GTI 1.8D 1.9D & 1.9TurboD boîte/gear box BE1 BE3 MA & 4HP14 sauf/except GTX		03/83 -> 07/88	500980	985 CI	612364
205 1.6 1.6 GTI 1.9 GTI 1.8D 1.9D & 1.9TurboD boîte/gear box BE1 BE3 MA & 4HP14 sauf/except GTX		03/83 -> 07/88	NEW 554852	1100	612372
205 1.6 1.6 GTI 1.9 GTI 1.8D 1.9D & 1.9TurboD boîte/gear box BE1 BE3 MA & 4HP14 sauf/except GTX		07/88 -> 12/98	500892	890 CJ	6123C4-612379
205 1.6 1.6 GTI 1.9 GTI 1.8D 1.9D & 1.9TurboD boîte/gear box BE1 BE3 MA & 4HP14 sauf/except GTX		07/88 -> 12/98	500902	890 CP	6123C4-612379
205 1.6 1.6 GTI 1.9 GTI 1.8D 1.9D & 1.9TurboD boîte/gear box BE1 BE3 MA & 4HP14 sauf/except GTX		07/88 -> 12/98	NEW 554853	1100	6123C5-9608053080
205 GTX boîte/gear box BE1 BE3 MA & 4HP14		03/83 -> 12/98	Not available		612365

Véhicule Vehicle	Type	Année Year	SEIM P/n	Longueur Length	OE
PEUGEOT					
<i>Suite...</i>					
305					
305 all model sauf/except GT/GTX		07/77 -> 07/82	500810	810 DJ	612283
305 all model sauf/except GT/GTX		07/82 -> 06/89	500800	800 DJ	612320
305 GT GTX		07/77 -> 06/89	501020	1020 CP	612374
306					
306 all model		> 96	500896	900 CL	6123H3-9621631180
309					
309 all model sauf/except GTI & GTI 16S		10/85 -> 12/93	500892	890 CJ	6123C4-612379
309 all model sauf/except GTI & GTI 16S		10/85 -> 12/93	500902	890 CP	6123C4-612379
309 GTI & GTI 16S		10/85 -> 12/93	500871	870 CJ	6123C3
405					
405 all model essence/gasoline sauf/except 4x4 & Taxi		07/87 -> 06/92	500892	890 CJ	6123C4-612379
405 all model essence/gasoline sauf/except 4x4 & Taxi		07/87 -> 06/92	500902	890 CP	6123C4-612379
405 all model Diesel sauf/except Taxi		07/87 -> 06/92	500971	970 CP	612395-9600865380
405 all model 4x4		07/87 -> 06/92	Not available		6123A5
405 all model sauf/except 4x4 & Taxi		07/92 -> 10/96	500943	940 CL	6123H7-9622641080-6123F3
405 4x4 all model sauf/except Turbo 16		07/92 -> 10/96	Not available	720 LB	6123H9-6123E8
405 Turbo 16		07/92 -> 10/96	500913	910 CL	6123H8-6123F2
504					
504 GL		09/68 -> 09/76	501811	1810 AG	612238
504 GL		09/68 -> 79	501810	1810 DG	612270
504 L GR SR		10/83 ->	501813	1810 DJ	612350
505					
505 all model 4 vitesses/4 speed sauf/except TI GTI STI & Turbo i		07/79 -> 06/83	501621	1620 DI 3	612316-612290-7920076423
505 all model 4 vitesses/4 speed sauf/except TI GTI STI & Turbo i		07/83 -> 92	501622	1620 DI 2,6	612348-612342-9252954480
505 all model 5 vitesses/5 speed sauf/except TI GTI STI & Turbo i		07/79 -> 06/83	501940	1940 DI 3	612314
505 all model 5 vitesses/5 speed sauf/except TI GTI STI & Turbo i		07/83 -> 92	501942	1940 DI 2,6	612346
505 all model TI GTI STI & Turbo i			Not available		
605					
605 all model sauf/except Taxi			500972	970 CL	6123F4-9616683680
806					
806 version emboîté/followed suit version	Version emboîté Followed suit version	07/94 -> OPR 06778 (05/95)	501120	1120 CN	6123H0
806 version clipsée/clipped version	Version clippé Clipped version	OPR 06778 (06/95)-> 07/02	554654	1120CJ	6123L1-9618182680
BOXER					
BOXER 1000 & 1400 kg sans compte-tour /without tachometer boîte/gear box MLGU & MLST	Encliquetable Clickfit coupling	Sérial n° 15106790 (02/94)->	501510	1513 CM	6123K6-6123L3-6123G6 1306982080-1315809080
BOXER 1800 kg sans compte-tour/without tachometer	Encliquetable Clickfit coupling	02/94 ->	501400	1420 JC	6123K7
BOXER sans compte-tour/without tachometer boîte/gear box ME5T	Vissé Screw-on coupling	02/94 ->	501530	1530 KM	6123K2-6123G8
BOXER sans compte-tour/without tachometer boîte/gear box MG5T	Vissé Screw-on coupling	02/94 ->	501534	1420 KM	6123K3-1315807080
EXPERT					
EXPERT all model	Version emboîté Followed suit version	09/95 -> OPR 08210 (05/99)	501120	1120 CN	6123H0
EXPERT all model	Version clippé Clipped version	OPR 08210 (05/99) -> 12/03	554654	1120CJ	6123L1
J5					
J5 all model		09/81 -> 91	501240	1240 AM	6123E1-7666874-612399
J5 all model		91 -> 06/93	500990	1350 AM	6123C7-7745213-7666874

Véhicule Vehicle	Type	Année Year	SEIM P/n	Longueur Length	OE
PEUGEOT					
<i>Suite...</i>					
J5 all model		07/93 -> 06/94	501360	1350 KM	6123G4-7780909
J5 all model avec compteur/with tachometer	Côté Compteur Counter side	10/81 -> 06/94	Not available	1020 JG	6123K1-95598433
J5 all model avec compteur/with tachometer	Côté Boîte Gear box side	10/81 -> 06/94	Not available	630 AG	6123J6
J7 & J9					
J7 & J9 sans compteur/without tachometer		07/70 -> 06/86	502350	2350 AP	612341
J7 & J9 sans compteur/without tachometer		07/86 -> 91	502405	2470 ID	612386
J7 & J9 avec compteur/with tachometer	Côté Compteur Counter side	07/83 -> 06/86	Not available	490 KJ	6123A1
J7 & J9 avec compteur/with tachometer	Côté Boîte Gear box side	07/83 -> 06/86	Not available	1770 AG	95596431
J7 & J9 avec compteur/with tachometer	Côté Compteur Counter side	07/86 -> 91	Not available	620 IG	6123C9
J7 & J9 avec compteur/with tachometer	Côté Boîte Gear box side	07/86 -> 91	Not available	1750 DG	6123E0
RENAULT					
CLIO					
CLIO all model	Version clippé Clipped version	06/90 -> 08/98	500953	890 FP	7700796634-7700796635
CLIO I all model		06/90 -> 08/98	NEW 554854		7700841187
ESPACE					
ESPACE all model		07/84 -> Ch.387 (09/85)	501401	1400 FP	7701349411-7700666388 7701348778
ESPACE all model		Ch.388 (09/85) -> 03/91	501520	1520 FP	6025002131
ESPACE II all model avec faisceaux/with beam		04/91 -> 12/96	554682	1520 FJ	6025171366
LAGUNA					
LAGUNA I 1.6 1.8 2.0 2.2d & 2.2dT		04/98 -> 11/00	501955	300 G F	7700842198
LAGUNA I 1.6 1.8 2.0 2.2d & 2.2dT avec faisceaux/with beam		04/98 -> 11/00	NEW 555151		7700410338
MASTER					
MASTER all model avec traction AV/ with front wheel drive 4 vitesses/4 speed		-> 02/89	501150	1150 JK	5000409595-5000409598
MASTER all model avec traction AV/ with front wheel drive 5 vitesses/5 speed		-> 02/89	501300	1300 JK	5000409849
MASTER all model avec traction AV/ with front wheel drive 5 vitesses/5 speed		03/89 -> 09/97	501552	1550 JK	7700748162
MASTER B70 B110 all model propulsion AR/ with rear wheel drive		-> 02/89	502440	2450 JK	5000409741
MASTER all model propulsion AR/ with rear wheel drive		03/89 -> 09/97	502900	2900 JK	7700743361
R4					
R4 L-TL		08/61 -> 07/82	Not available		7700557141-7701348898
R4 L-TL		07/82 -> 12/92	501551	1550 FP	7701349473-7701348478 7701348243
R4 GTL-F4-RODEO 6		04/68 -> 07/82	501650	1650 FG	7700625620-77005 87025
R4 GTL-F4-RODEO 6		07/82 -> 12/92	501670	1770 FP	7701349474
R5					
R5 L		01/74 -> 07/82	Not available	1400 DB	7700531808-7701348388
R5 L		07/82 06/86	501401	1400 FP	7701349411-770134444 7701348778
R5 TL-GTL-LS-TS-ALPINE		07/79 -> 06/86	501551	1550 FP	7701349473-7701348478 7701348243

Véhicule Vehicle	Type	Année Year	SEIM P/n	Longueur Length	OE
RENAULT					
R9 & R11					
R9 & R11 all model		07/81 -> 06/89	500952	950 FP	7701349842-7701348372 7700704381
R12					
R12 all model			501540	1530 DJ	7701348732-7701348395 7700639745
R18					
R18 all model 4 vitesses/4 speed		04/78 -> 12/86	501410	1410 PJ	7701348245-7700 634181
R18 all model & FUEGO 5 vitesses/5 speed		04/78 -> 12/87	501401	1400 FP	7701349411-7701349444 7701348778
R19					
R19 & CHAMADE all model sauf/except 16S & ordinateur de bord/on-board computer		07/89 -> 04/97	501801	1180 FJ	7701044136-7701349863
R20					
R20 all model			501540	1530 DJ	7701348732-7701348395 7700639745
R21					
R21 & NEVADA GTX TXE TD GTD TURBO D/DX RN 2.1d & RT 2.1Di		01/86 -> 12/95	501411	1410 FP	7700790984-7700765535
R21 & NEVADA TL GTL TS GTS TSE TSi GTSi 2L TURBO		01/86 -> 12/95	501100	1100 FP	7700802102-7700765534 7700785695
R21 & NEVADA AUTOMATIC GTS GTX TSE & TXE			Not available		7700783128
R25					
R25 all model		03/84 -> 06/92	501401	1400 FP	7701349411-7700778141
R30					
R30 TURBO D			Not available	1540 FJ	7700676123
SAFRANE					
SAFRANE 2.1dT & 2.5dT		04/92 -> 09/96	NEW 554855		7700845259
SUPERCINQ & EXPRESS					
Super 5 & EXPRESS all model sauf/ except automatic		09/84 -> 09/94	500952	950 FP	7701349842-7701348372 7700704381
Super 5 & EXPRESS all model sauf/except automatic		09/94 -> 12/96	501023	1000 FJ	7700272069-7700354188
SUPER 5 automatic all model		09/84 -> 12/96	501950	1950 FJ	7700785624
TRAFIC					
TRAFIC avec traction AV/with front wheel drive & 4X4 essence/gasoline 1647cm3		09/80 -> 11/97	501220	1220 FJ	7700713806
TRAFIC avec traction AR/with rear wheel drive essence/gasoline 1647cm3		09/80 -> 11/97	501840	1850 FP	7700671927
TRAFIC all model		->09/1994 09/1994->	505330	1510 FP	7700665336-7700310629

SEAT					
CORDOBA					
CORDOBA all model		86 ->	505200	1270 L1 K1	SE022130327A-X03963310
IBIZA					
IBIZA all model		86 ->	505200	1270 L1 K1	SE022130327A-X03963310
MALAGA					
MALAGA all model		85 -> 07/92	505200	1270 L1 K1	SE022130327A-X03963310
RONDA					
RONDA all model		07/85 -> 92	505200	1270 L1 K1	SE022130327A-X03963310

SUZUKI					
SANTANA					
SANTANA S410 S413			504405	2250 R1 J1	3491080030

Véhicule Vehicle	Type	Année Year	SEIM P/n	Longueur Lenght	OE
TALBOT					
HORIZON					
HORIZON		78 -> 86	Not available	910 CE	5223958
SAMBA					
SAMBA		82 -> 07/84	500901	900 DJ	6123246122 96
SAMBA		07/84 -> 86	500942	940 DJ	612373

VOLKSWAGEN					
GOLF					
GOLF I & II 1.6 1.8 sauf/except 1.3		78 -> 85	505020	990 D1 E1	171957803H
GOLF II all model sauf/except 1.3		85 ->	505030	1100 F1 E1	191957803D
PASSAT					
PASSAT III all model		93 -> 10/96	505328	1420 J1 U1	321957803AC-357957803A
POLO					
POLO all model avec servo frein/with servo brake		85 ->	505210	1230 L1 S1	861957801A
POLO all model avec servo frein/with servo brake		85 ->	505220	1100 L1 S1	861957801B

Embout de compteur - Speedometer end fitting

Embout A

Embout A1

Embout A2

Embout B

Embout B1

Embout B2

Embout C

Embout C1

Embout C2

Embout D

Embout D1

Embout D2

Embout D3

Embout E

Embout E1

Embout E2

Embout de compteur - Speedometer end fitting

Suite...

Embout F

Embout F1

Embout F2

Embout G

Embout G1

Embout G2

Embout H

Embout H1

Embout H2

Embout I

Embout I1

Embout I2

Embout J

Embout J1

Embout J2

Embout K

Embout K1

Embout L

Embout L1

Embout M

Embout M1

Embout N

Embout N1

Embout O1

Embout de compteur - Speedometer end fitting

Suite...



Embout P



Embout P1



Embout Q1



Embout R1



Embout S1



Embout T1



Embout V1



Embout W1



Embout X1



Embout Y1



Embout Z1



Lined area for notes with horizontal dotted lines.

2014-2015

Câbles de boîte à vitesse



Gear shift cables

Cavi del cambio

*Cables de cambio
de marcha*

Gangschaltkabel

Sommaire Contents

ALFA ROMEO	39
CITROËN.....	39
DACIA	39
FIAT	40
FORD.....	40
IVECO.....	40
MERCEDES	40
MINI	41
NISSAN	41
OPEL.....	41
PEUGEOT	41
RENAULT	42
SEAT	44
TOYOTA.....	44

Comment utiliser l'onglet câble de boîte à vitesse ?

How to use gear shift cable tab ?

Véhicule Vehicle	Type	Année Year	SEIM P/n	Longueur Length	OE
RENAULT Suite...					
LAGUNA III					
LAGUNA III 1.6 16v-2.0 16v 140cv 1.5 DCI 110cv-2.0 DCI 130-150-175-180cv	Double câble	10/07>	NEW 554830		8200755652
LAGUNA III 2.0 16v ETHANOL-1.5 DCI 110cv		11/10>	Not available		8200933375
LAGUNA III 2.0 16v Turbo-2.0 DCI 130-150-180cv		11/10>	NEW 554831		8200930211
LAGUNA III COUPE 2.0 DCI 150 sans FAP		10/08->04/09	Not available		8200694900
LAGUNA III COUPE 2.0 DCI 150 sans FAP		04/09>	Not available		8200933375
LAGUNA III COUPE 2.0 DCI 150 sans FAP		10/08>	NEW 554830		8200755652
LAGUNA III COUPE 2.0 16v Turbo 205cv - 2.0 DCI 150-175-180cv avec/with FAP		10/08>	NEW 554833		8200930211
LAGUNA III COUPE 2.0 16v Turbo 205cv - 2.0 DCI 150-175-180cv avec/with FAP		10/08>	Not available		8200933373-8200743573
LATITUDE					
LATITUDE 2.0 DCI 150cv FAP		10/10>	Not available		8200902291
MEGANE I					
MEGANE I 1.6 16v -2.0-1.9 dTi Automatic		11/95->10/02	NEW 554834		8200483399
MEGANE I 1.6i Automatic		11/95->03/99	NEW 554833		7700819870
MEGANE II					
MEGANE II, MEGANE II CC & MEGANE II ESTATE 2.0 16v-2.0i 16v Turbo 163cv-2.0i Turbo SPORT & F1 224 & 230cv-1.5 DCI 105cv 1.9 DCI 120 & 130cv-2.0 DCI 150 & 175cv	Simple câble	09/02->06/09	NEW 554835		34445349
MEGANE II, MEGANE II CC & MEGANE II ESTATE 1.4 16v 80 & 98cv-1.6-1.6 16v 1.6 16v GPL & Ethanol-1.5 DCI 80-85-100cv		09/02->06/09	Not available		7701474701
MEGANE III					
MEGANE III 1.2 Tce 115cv-1.4 16v Tce 130cv- 1.6i 16v 110cv-1.5 DCI 105 & 110cv	Double câble	11/08>	NEW 554820		8200781046
MEGANE III 1.5 DCI 85 & 90cv		11/08>	Not available		8200779393
MEGANE III 2.0 Tce 180cv-2.0 HDI 160cv		11/08>	Not available		8200936261
MODUS					
MODUS GRAND MODUS 1.2 16v 75cv- 1.2 Tce 100cv-1.5 DCI 65-70-80-85cv	Avec levier With shift lever	09/04->12/12	NEW 554837		8200755868
R19					
R19 1.7i-1.8i Automatic		07/88->03/96	NEW 554812		7700858024
SAFRANE					
SAFRANE 2.0i-2.2Si-V6i-2.1dF2.5dT		04/92->09/96	NEW 554838		7701466936
SAFRANE 2.2dT		09/96->23/09/96	NEW 554838		7701466936
SAFRANE 2.2dT		23/09/96->08/00	NEW 554839		7701470266
SCENIC					
SCENIC 1 1.6 16v -2.0-2.0 16v- 1.9 dTi Automatic		09/96->06/03	NEW 554834		8200933399
SCENIC 1 1.6 e Automatic		09/96->08/99	Not available		7700017
SCENIC 1 1.6i Automatic		09/96->08/99	NEW 554833		7700819870
TRAFIC II					
TRAFIC II			Not available	1213/930	8200054761-7701473971
TRAFIC II	Double câble		NEW 554808	1295/975	4432979-93198015-7701477671

 Modèle
 Model

 Date de fabrication
 Date of manufacture

 Référence d'origine
 OE P/n

 Référence Seim
 Seim P/n

 Longueur en mm :
 Câble/Gaine
 Length in mm
 Cable/girdle

**Pour toutes questions notre service technique est disponible
 du lundi au vendredi de 8H00 à 12H15 et de 13H15 à 17H00
 Tél. 04 74 46 07 36**

Véhicule Vehicle	Type	Année Year	SEIM P/n	Longueur Length	OE
ALFA ROMÉO					
ALFA MITO					
MITO 1.4MPi 16v 78ch	Simple câble	09/08->	NEW 554769	1130/835	55230721-55199359
MITO 1.4MPi 16v 78ch	Simple câble	09/08->	NEW 554770	1325/960	55230720-55199358
MITO 1.3 MJTD 90ch BV6/6 speed	Simple câble	09/08->	NEW 554771	1185/790	55199874
MITO 1.3 MJTD 85-90ch BV6/6 speed	Simple câble	09/08->	NEW 554772	1190/800	55230718-55223406-55199873

CITROËN					
C1					
C1 1.0 i 68cv		06/05->	NEW 554773		2444AT-338200H010
C1 1.4 HDI		06/05->	Not available		2444AX-338200H020
C2					
C2 1.1i-1.4i 75cv-1.4i 16v & 1.6 i 16v-Boîte/ Gear box MA	Double câble	09/03->OPR 11437	NEW 554774		2444FC
C2 1.4 HDI 70cv Mot DV4TD Boîte/ Gear box MA	Double câble	09/03->10-2008	NEW 554775	1035/810+ 1090/770	2444FE-2444V0-2444CR
C2 1.1i-1.4i 75cv-1.4i 90cv-1.6 i 16v-1.4 HDI 1.6HDI 110cv- Boîte/Gear box BE4R		09/03->	NEW 554776		2444CZ
C3					
C3 1.1i-1.4i-1.4i 16v & 1.6 i 16v & BV/ gear box MA	Double câble	04/02-> OPR 11437	NEW 554774		2444FC
C3 1.4 HDI 70cv Mot DV4TD & BV/ gear box MA	Double câble	04/02-> OPR 11437	NEW 554775	1035/810+ 1090/770	2444FE-2444V0-2444CR
C3 1.1i-1.4i-1.4i 16v-1.6 i 16v & 1.6 110cv & BV/gear box BE4R		04/02->12/10	NEW 554776		2444CZ
C3 1.4 HDI 90cv & 1.6 HDI 92cv BV/ gear box BE4R		04/02->12/10	NEW 554777		2444X6
C3 1.4i-1.6 i 16V Automatic		04/02->12/10	Not available		2444V1
JUMPER					
JUMPER	Simple câble	02/94->02/02	NEW 554786	960/690	1329696080
JUMPER	Simple câble	02/94->02/02	NEW 554787	1000/750	1329695080 - 1318942080
JUMPER	Simple câble	02/94->02/02	NEW 554788		1329700080
JUMPER	Simple câble	02/94->02/02	NEW 554789		1329699080
XSARA					
XSARA II 2.0 HDI 110cv Automatic	Simple câble	09/00->12/05	NEW 554780		2444Q6-9639440380
XSARA II 1.6 16v-2.0 16v Automatic		09/00->12/05	NEW 554781		2444Q7-9647962480
XSARA II 2.0 HDI 110cv Automatic		09/00->12/05	Not available		2150T7-9647986280
XSARA PICASSO					
XSARA PICASSO 1.6i-1.8i-1.6 HDI 92 & 110cv-2.0 HDI 90cv		12/99->12/10	NEW 554782		2444P4-9635550180
XSARA PICASSO 2.0 16v Automatic		12/99->12/10	Not available		2444X0

DACIA					
DOKKER					
DOKKER 1.2 TCE 115cv-1.6 MPI 85cv- 1.5 DCI 75-90cv	Avec levier With shift lever	09/12->	NEW 554783		349011400R
LODGY					
LODGY 1.2 TCE 115cv-1.6 MPI 85cv- 1.5 DCI 75-90cv	Avec levier With shift lever	01/12->	NEW 554783		349011400R
LOGAN					
LOGAN II TCE 90cv-1.5 DCI 75-90cv	Avec levier With shift lever	10/12->	NEW 554785		349017122R
SANDERO					
SANDERO II TCE 90cv-1.5 DCI 75-90cv	Avec levier With shift lever	10/12->	NEW 554785		349017122R

Véhicule Vehicle	Type	Année Year	SEIM P/n	Longueur Length	OE
FIAT					
GRANDE PUNTO					
GRANDE PUNTO 1.2-1.4-1.4 16v-1.4 GPL-1.4 GNV	Simple câble	09/05->	NEW 554769	1130/835	55230721-55199359
GRANDE PUNTO 1.2-1.4-1.4 16v-1.4 GPL-1.4 GNV		09/05->	NEW 554770	1325/960	55230720-55199358
GRANDE PUNTO 1.3 MJDT 16v 90cv BV6/6 speed		09/05->	NEW 554771	1185/790	55199874
GRANDE PUNTO 1.3 MJDT 16v 90cv BV6/6 speed	Simple câble	09/05->	NEW 554772	1190/800	55230718-55223406-55199873
PUNTO EVO					
PUNTO EVO 1.2 65cv-1.2 69cv-1.4 16v Turbo 135cv		10/09->	Not available		55231153
PUNTO EVO 1.2 65cv-1.2 69cv-1.4 16v Turbo 135cv		10/09->	NEW 554770	1325/960	55230720-55199358
PUNTO EVO 1.6 MJTD 16v 120cv		10/09->	NEW 554771	1185/790	55199874
PUNTO EVO 1.6 MJTD 16v 120cv	Simple câble	10/09->	NEW 554772	1190/800	55230718-55223406-55199873
PUNTO III					
PUNTO III 0.9 85cv		01/12->	Not available		55231153
PUNTO III 0.9 85cv		01/12->	NEW 554770	1325/960	55230720-55199358
DUCATO					
DUCATO	Simple câble	02/94->02/02	NEW 554786	960/690	1329696080
DUCATO	Simple câble	02/94->02/02	NEW 554787	1000/750	1329695080 - 1318942080
DUCATO	Simple câble	02/94->02/02	NEW 554788		1329700080
DUCATO	Simple câble	02/94->02/02	NEW 554789		1329699080 - 1320018080

FORD					
TRANSIT					
TRANSIT II all model	Simple câble	10/94->08/00	NEW 554791	800/510	1335005-2C1R7E395AB
TRANSIT III all model	Simple câble	08/00->09/06	NEW 554792	800/535	1213025-2C1R7E395BA-1C1R7E395CB
TRANSIT III all model	Simple câble	08/00->09/06	NEW 554793	800/520	1213023-2C1R7E395AA-1C1R7E395BB
TRANSIT CONNECT					
TRANSIT CONNECT			Not available	1155/890+ 1250/905	1208559-2T1R7E395AB
TRANSIT CONNECT	Double câble		NEW 554790	1150/890+ 1240/905	1764202-BT1R7E395AB

IVECO					
DAILY					
DAILY 35C-25S	Simple câble	99->	NEW 554794	1215/930	500317509
DAILY 35C-25S	Simple câble	99->	NEW 554795	760/480	504034853-500317684

MERCEDES					
SPRINTER					
SPRINTER (909) 308 & 408 CDI BVM5 au PLANCHER TSG 330 (code GR1)			NEW 554798		A9092670000
SPRINTER (901) 208 CDI-211 CDI-213 CDI			NEW 554797		A9012601538
SPRINTER (905) 616 CDI			NEW 554797		A9012601538
SPRINTER (902) 214-208 CDI-211 CDI- 213 CDI-216 CDI			NEW 554797		A9012601538
SPRINTER (903) 314-308 CDI-311 CDI-313- 316 CDI			NEW 554797		A9012601538
SPRINTER (904) 414-408 CDI-411 CDI- 413 CDI-416 CDI			NEW 554797		A9012601538

Véhicule Vehicle	Type	Année Year	SEIM P/n	Longueur Lenght	OE
MERCEDES					
<i>Suite...</i>					
SPRINTER (901-902-903-904) 214-208 D-210 D-212 D Automatic Sauf 4x4			Not available		A9012670264
VITO					
Vito II (639)		10/03->09/10	NEW 554799	1155/820	0002680191
Vito II (639)		10/03->09/10	NEW 554800	1050/785	0002680091
VIANO					
Viano II (639)		10/03->09/10	NEW 554799	1155/820	0002680191
Viano II (639)		10/03->09/10	NEW 554800	1050/785	0002680091
MINI					
MINI					
MINI (R50/53) & MINI CABRIO (R52) 1.6i	Simple câble	07/04->09/06	NEW 554801	1236/888	25117547368
MINI (R50/53) & MINI CABRIO (R52) 1.6i		07/04->09/06	Not available	1219/924	25117547369
MINI (R50/53) D ONE 75 & 88cv	Simple câble	09/01->09/06	NEW 554802	1047/720	25117547370
MINI (R50/53) D ONE 75 & 88cv		09/01->09/06	Not available	1010/730	25117547371
NISSAN					
ATLEON					
ATLEON	Double câble	99->	NEW 554803	3260/3075 3010/2830	344139X403-344139X125
CABSTAR					
CABSTAR TL	Double câble	99->	NEW 554804	3165/2805 2820/2470	344139X205-344139X201
CABSTAR TL	Double câble	99->	NEW 554805	2890/2685 2875/2695	344139X514-344139X50A
OPEL					
MOVANO					
MOVANO 2.2 DCI		09/97->11/03	NEW 554806	985/655 1140/830	8200134485
MOVANO	Simple câble	09/97->11/03	NEW 554807	945/615 1100/795	8200134483
VIVARO					
VIVARO			Not available	1215/930 1295/975	8200054761-7701473971
VIVARO	Double câble		NEW 554808		4432979-93198015-7701477671
PEUGEOT					
107					
107 1.0 i 68cv		06/05->	NEW 554773		2444AT-338200H010
107 1.4 HDI		06/05->	Not available		2444AX-338200H020
205					
205 1.6i Automatic		07/87->12/98	NEW 554809		2444K7-9402444K78
309					
309 1.6i Automatic		07/89->12/93	NEW 554809		2444K7-9402444K78
405					
405 1.8i-1.9i-2.0i Automatic		07/87->10/96	NEW 554810		2444K8-9634108880
BOXER					
BOXER	Simple câble	02/94->02/02	NEW 554786	960/690	1329696080
BOXER	Simple câble	02/94->02/02	NEW 554787	1000/750	1329695080 - 1318942080
BOXER	Simple câble	02/94->02/02	NEW 554788		1329700080
BOXER	Simple câble	02/94->02/02	NEW 554789		1329699080

Véhicule Vehicle	Type	Année Year	SEIM P/n	Longueur Length	OE
PEUGEOT					
EXPERT					
EXPERT 1.9D		10/95>12/03	NEW 554778		2444CA-1499328080
EXPERT 2.0 HDI 95 cv		10/95>12/03	Not available		2444AR-1496246080
RENAULT					
CAPTUR					
CAPTUR		13>	NEW 554811		349017913R
CLIO					
CLIO I 1.4i-1.8i Automatic		06/90>08/98	NEW 554812		7700858024
CLIO II 1.4 16v-1.6-1.6 16v Automatic		03/98>26/01/01	NEW 554814		8200433397
CLIO II 1.4 16v-1.6-1.6 16v Automatic		26/01/01>07/06	NEW 554813		8200433264
CLIO III & CLIO III ESTATE 1.2 16v 65 & 75cv 1.2 TCe 100cv-1.4 16v 100cv-1.6 16v 110cv- 2.0 16v 140 & 200cv-1.5 DCI 70-85-105cv	Avec levier With shift lever	09/05>	NEW 554815		8200755871
CLIO III & CLIO III ESTATE 1.2 16v 65 & 75cv 1.2 16v 75 cv GPL & Ethanol-1.2 TCe 100cv- 1.5 DCI 70 & 85cv		03/09>	Not available		349352288R
CLIO IV & CLIO IV ESTATE 0.9 TCE-1.2 75cv	Avec levier With shift lever	07/12>	NEW 554816		349014605R
ESPACE					
ESPACE III 2.0 16v Automatic	Simple câble	12/96>09/02	NEW 554817	820+219	6025314170
ESPACE III & GRAND ESPACE III V6 Automatic		12/96>09/02	Not available		6025316578
ESPACE IV & ESPACE IV LONG 2.0 16v 140 cv 2.0 16v Turbo 170cv-1.9 DCI 117cv		03/06>07/12	NEW 554818		8200748190
ESPACE IV & ESPACE IV LONG 2.0 DCI 1.30-1.50-1.75cv-2.2 DCI 150 cv		03/06>07/12	NEW 554819		8200748182
FLUENCE					
FLUENCE 1.5 DCI 105cv	Double câble	01/10>	NEW 554820		8200781046
FLUENCE 1.5 DCI 85cv		01/10>	Not available		8200779393
KANGOO					
KANGOO I 1.6 16v Automatic		03/03>12/07	NEW 554822		8200433259
KANGOO I 1.5 DCI 60-65-70-85cv	Simple câble	03/03>06/10	NEW 554823	940/625	7701479154
KANGOO 1.5 DCI 60-65-70-85cv	Simple câble	03/03>06/10	NEW 554821	880/590	7701479155
MASTER					
MASTER I	Double câble	>09/97	NEW 554832		7701470938
MASTER II 2.2 DCI		09-97>	NEW 554806	985/655 1140/830	8200134485
MASTER II	Simple câble	09-97>	NEW 554807	945/615 1100/795	8200134483
LAGUNA I					
LAGUNA I V6 & 2.2dT		01/94>09/96	NEW 554824		7701467862
LAGUNA I V6 & 2.2dT-1.9 DCI	Double câble	09/96>11/00	NEW 554825		7701472188
LAGUNA I V6 BV AUTO		04/98>11/00	Not available		7700105589
LAGUNA I 2.0i-1.9dTi Automatic		04/98>11/00	Not available		7700105588
LAGUNA II					
LAGUNA II 2.0 Turbo 16v-1.9 DCI 95-110 & 120cv-2.0 DCI 150cv-2.2 DCI 150cv		11/00>09/07	NEW 554829		8200777666
LAGUNA II 1.9 DCI 110-125-130cv FAP- 2.0 DCI 175cv FAP		03/05>09/07	NEW 554826		8200777667
LAGUNA II 1.6 16v-1.8 16v-2.0 16v-2.0 ide- 1.9 DCI 100cv		11/00>03/05	NEW 554827		8200777668
LAGUNA II 1.6 16v & 2.0 16v		03/05>09/07	Not available		8200777668
LAGUNA II 1.8 16v-2.0 16v Automatic		11/00>03/05	NEW 554828		7701477644-7701473277
LAGUNA II 2.0 16v-1.9 DCI 115cv Automatic		03/05>09/07	NEW 554828		7701477644-7701473277

Véhicule Vehicle	Type	Année Year	SEIM P/n	Longueur Length	OE
RENAULT					
LAGUNA III					
LAGUNA III 1.6 16v-2.0 16v 140cv- 1.5 DCI 110cv-2.0 DCI 130-150-175-180cv	Double câble	10/07->	NEW 554830		8200755652
LAGUNA III 2.0 16v ETHANOL-1.5 DCI 110cv		11/10->	Not available		8200933375
LAGUNA III 2.0 16v Turbo-2.0 DCI 130-150-180cv		11/10->	NEW 554831		8200930211
LAGUNA III COUPE 2.0 DCI 150 sans FAP		10/08->04/09	Not available		8200694900
LAGUNA III COUPE 2.0 DCI 150 sans FAP		04/09->	Not available		8200933375
LAGUNA III COUPE 2.0 DCI 150 sans FAP		10/08->	NEW 554830		8200755652
LAGUNA III COUPE 2.0 16v Turbo 205cv - 2.0 DCI 150-175-180cv avec/with FAP		10/08->	NEW 554833		8200930211
LAGUNA III COUPE 2.0 16v Turbo 205cv - 2.0 DCI 150-175-180cv avec/with FAP		10/08->	Not available		8200933373-8200743573
LATITUDE					
LATITUDE 2.0 DCI 150cv FAP		10/10->	Not available		8200902291
MEGANE I					
MEGANE I 1.6 16v -2.0-1.9 dTi Automatic		11/95->10/02	NEW 554834		8200433399
MEGANE I 1.6i Automatic		11/95->03/99	NEW 554833		7700869870
MEGANE II					
MEGANE II, MEGANE II CC & MEGANE II ESTATE 2.0 16v-2.0i 16v Turbo 163cv-2.0i 16v Turbo SPORT & F1 224 & 230cv-1.5 DCI 105cv 1.9 DCI 120 & 130cv-2.0 DCI 150 & 175cv	Simple câble	09/02->06/09	NEW 554835		344453493R-7701474698
MEGANE II, MEGANE II CC & MEGANE II ESTATE 2.0 16v-2.0i 16v Turbo 163cv-2.0i 16v Turbo SPORT & F1 224 & 230cv-1.5 DCI 105cv 1.9 DCI 120 & 130cv-2.0 DCI 150 & 175cv	Simple câble	09/02->06/09	NEW 554836		314156687R-7701474699
MEGANE II, MEGANE II CC & MEGANE II ESTATE 1.4 16v 80 & 98cv-1.6-1.6 16v- 1.6 16v GPL & Ethanol-1.5 DCI 80-85-100cv		09/02->06/09	Not available		7701474701
MEGANE III					
MEGANE III 1.2 Tce 115cv-1.4 16v Tce 130cv- 1.6i 16v 110cv-1.5 DCI 105 & 110cv	Double câble	11/08->	NEW 554820		8200781046
MEGANE III 1.5 DCI 85 & 90cv		11/08->	Not available		8200779393
MEGANE III 2.0 Tce 180cv-2.0 HDI 160cv		11/08->	Not available		8200936261
MODUS					
MODUS GRAND MODUS 1.2 16v 75cv- 1.2 TCe 100cv-1.5 DCI 65-70-80-85cv	Avec levier With shift lever	09/04->12/12	NEW 554837		8200755868
R19					
R19 1.7i-1.8i Automatic		07/88->03/96	NEW 554812		7700858024
SAFRANE					
SAFRANE 2.0i-2.2Si-V6i-2.1dT-2.5dT		04/92->09/96	NEW 554838		7701466936
SAFRANE 2.2dT		09/96->23/09/96	NEW 554838		7701466936
SAFRANE 2.2dT		23/09/96->08/00	NEW 554839		7701470266
SCENIC					
SCENIC I 1.6 16v -2.0-2.0 16v- 1.9 dTi Automatic		09/96->06/03	NEW 554834		8200433399
SCENIC I 1.6 e Automatic		09/96->08/99	Not available		7701470017
SCENIC I 1.6i Automatic		09/96->08/99	NEW 554833		7700869870
TRAFIC II					
TRAFIC II			Not available	1215/930 1295/975	8200054761-7701473971
TRAFIC II	Double câble		NEW 554808		4432979-93198015-7701477671
TWINGO					
TWINGO I Automatic		04/93->06/07	NEW 554840		7700110653
TWINGO II 1.6 16v 133cv	Avec levier With shift lever	06/07->11/11	NEW 554845		8200781228

Véhicule Vehicle	Type	Année Year	SEIM P/n	Longueur Length	OE
RENAULT Suite...					
TWINGO II 1.5 DCI 65cv	Câble simple	06/07>11/11	NEW 554842	580+140	7701071159
TWINGO II 1.5 DCI 65cv	Câble simple	06/07>11/11	NEW 554841	605+140	7701071158
TWINGO II 1.5 DCI 65cv		06/07>11/11	Not available		8200806254-8200517000
TWINGO II 1.5 DCI 75-85cv	Simple câble	12/11>	NEW 554847	605+140	344458344R
TWINGO II 1.5 DCI 75-85cv		12/11>	Not available		344453071R
TWINGO II 1.5 DCI 75-85cv	Avec levier With shift lever	12/11>	NEW 554848		8201036855
TWINGO II 1.2 16v Tce 100cv	Simple câble	06/07>	NEW 554843	580+140	7701071160
TWINGO II 1.2 16v Tce 100cv		06/07>	NEW 554846		7701071163
TWINGO II 1.2 16v Tce 100cv	Avec levier With shift lever	06/07>	NEW 554844		8200806256
TWINGO II 1.6 16v 133cv		06/07>	Not available		7701071166
VELSATIS					
VELSATIS 2.0 16v 2.2 DCI 115 & 150cv		01/02>12/09	NEW 554849		8200748174
VELSATIS 2.2 DCI 140cv		04/05>12/09	NEW 554850		8200748176

SEAT					
ALHAMBRA					
ALHAMBRA 1.8i 20 VF 2.8 V6-19-1.9 TDI		CH SERIE 7M-3-515801-> 05-2010	NEW 554851		7M3713265F

TOYOTA					
AYGO					
AYGO 1.0 i 68cv		06/05>	NEW 554773		2444AT-338200H010
AYGO 1.4 D4D		06/05>	Not available		2444AX-338200H020

2014-2015

Câbles de débrayage



Clutch cables
Cavi disinnesto
Frizione
Mando embrague



Sommaire Contents

AUDI.....	47
CHEVROLET/DAEWOO.....	47
CHRYSLER	47
CITROËN.....	47
DACIA	51
FIAT	51
FORD.....	53
HYUNDAI.....	54
IVECO.....	55
KIA	55
LADA	55
LANCIA.....	55
MAZDA.....	55
MERCEDES.....	55
NISSAN	55
OPEL.....	56
PEUGEOT	57
RENAULT	62
ROVER	65
SEAT	65
SUZUKI	67
TALBOT	68
TOYOTA	68
VOLKSWAGEN.....	68

ACCESSOIRES DEBRAYAGE CLUTCH ACCESSORIES.....	70
--	----

Comment utiliser l'onglet câble de débrayage? How to use clutch cable tab ?



Câbles de débrayage

Véhicule Vehicle	Réf. chape Cable linkage	Type	Date de fabrication Date of manufacture	SEIM P/n	Longueur Lenght	Longueur en mm : Câble/Gaine Lenght in mm Cable/girdle
PEUGEOT						
PARTNER (M59) 1.9D-1.6 16V-1.6 HDI-2.0 HDI Boite/Gear box BE4R	310204 sauf 1.0HDI	Manual Adjust Auto Adjust	OPR 11190 [07/07] > OPR 11190 [07/07] >	Not available 554564	899/687	9806892280-2150CY 9664708080
CHAPE/BIELETTE POUR PEDALE DE DEBRAYAGE - CLUTCH CABLE LINKAGE						
all model sauf/except 2.0 HDI 07/07->			09/96 >	310204		212822-9633830686
2.0 HDI			07/07 >			212831
RENAULT						
CLIO						
CLIO all model			06/90 > 08/98	401300	990/610	7700421960-7700435284
CLIO II all model		Manual	03/98 > 07/06	401690	954/667	8200741823-8200078017
KIT CREMAILLIERE DE DEBRAYAGE - CLUTCH PEDAL KIT						
CLIO				320208		7700679621
ESPACE						
ESPACE GTS TSE TXE 2000-1		Manual	07/84 > 04/91	401520	702/438	6025002833-6025002522
		Manual	07/84 > 04/91	401090	715/445	6025000718
		Manual	04/91 > 21/01/95	401430	1293/1100	6025103090
		Manual Adjust	01/95 > 06/97	401530	1300/1100	6025170728
		Auto Adjust	01/95 > 06/97	554598	1290/1150	6025103091-6025111500
ESPACE III 1.9 dTi 2.0i 2.0i 1.6V (seulement une masse coté embrayage only with one metal mass)		Manual Adjust	12/96 > 09/02	Not available	1070/900	6025171255-6025171256
ESPACE III 1.9 dTi (2 masses: 1 coté pédale & 1 coté BV/with 2 metal mass)		Auto Adjust	12/96 > 09/02	401540	1070/900	6025304915
ESPACE III Grand Espace 2.0i 2.0i 1.6V		Manual Adjust	12/96 > 09/02	401650	1070/910	6025312553
		Auto Adjust	12/96 > 09/02	554598	1070/900	
KANGOO						
KANGOO I 1.2-1.4-1.6-1.5 DCI-1.9D-1.9dTi sauf/except KANGOO EXPRESS						
KANGOO I 1.2-1.2 GPL-1.2 16v-1.4-1.6-1.6 16v-1.5 DCI 55,60,65, 70 & 80-1.9D sauf/except KANGOO EXPRESS						
KANGOO I EXPRESS 1.5 DCI 55,60,65, 70 & 80cv						
KANGOO I EXPRESS 1.2-1.2 16v & 1.6 16v						
KANGOO I EXPRESS 1.2-1.2 GPL-1.2 16v-1.6 16v-1.6GNV-1.9D						
LAGUNA						
LAGUNA & NEVADA 1.6 16V		Manual Adjust	01/94 > 09/98	401620	1180/910	7700431360
		Auto Adjust	01/94 > 09/98	401621		
LAGUNA & NEVADA 1.6 16V		Manual Adjust	09/98 > 11/00	Not available		7700432383
		Auto Adjust	09/98 > 11/00	401700	1125/866	
LAGUNA & NEVADA 1.8 1.8 16V & 2.0 (115cv)		Manual Adjust	01/94 > 09/98	Not available		7700413206-7700847976
		Auto Adjust	01/94 > 09/98	401610	1230/870	7700840014-7700824073
LAGUNA & NEVADA 1.8 1.8 16V & 2.0 (115cv)		Manual Adjust	09/98 > 11/00	Not available		7700432383
		Auto Adjust	09/98 > 11/00	401700	1125/866	
LAGUNA & NEVADA 1.9 dTi		Manual Adjust	01/04/98 > 30/04/98	Not available		7700421415
		Auto Adjust	01/04/98 > 30/04/98	554764		

 Modèle
 Model

 Référence Chape
 Voir photo en page 70
 Clutch cable linkage
 See photo in page 70

 Référence Seim
 Seim P/n

 Référence d'origine
 OE P/n

 Kit Crémaillères et références
 Voir photo en page 71
 Clutch pedal kit
 See photo in page 71

Type de câble / cable type

Manual : Câble de débrayage avec réglage manuel
Manual : Clutch cable with manual adjustment

Manual Adjust : Adaptation en version manuelle qui se monte en lieu et place du câble à rattrapage automatique
Manual Adjust : Clutch cable with manual adjustment which fits in place of automatic adjustment cable.

Auto Adjust : Câble à Rattrapage automatique
Auto Adjust : Clutch cable with automatic adjustment

**Pour toutes questions notre service technique est disponible
du lundi au vendredi de 8H00 à 12H15 et de 13H15 à 17H00
Tél. 04 74 46 07 36**

Véhicule Vehicle	Réf. chape Cable linkage	Type	Année Year	SEIM P/n	Longueur Length	OE
AUDI						
AUDI 80						
AUDI 80 1.6 1.8		Manual	84 >	550350	920/620	811721335Q
CHEVROLET / DAEWOO						
AVEO						
AVEO all model		Manual	03/06 >	554561	888/595	96339736
KALOS						
KALOS all model		Manual	03 >	554561	888/595	96339736
MATIZ						
MATIZ all model		Manual	98 >	734200	851/576	96315242
CHRYSLER						
VOYAGER						
VOYAGER all model		Manual	86 > 89	355005	1050/600	4377770
CITROËN						
2CV						
2 CV Berline all model		Manual	03/70 >	100010	699/515	95494917
2 CV fourgonnette AKS 400 kg		Manual	Orig >	100010	699/515	95494917
2 CV fourgonnette sauf/except AKS 400 kg		Manual	01/72 >	100010	699/515	95494917
AX						
AX all model		Manual	09/86 > 09/90	101030	640/460	96046150-9604615080 95598955
AX all model sauf/except 1.4i (TU3FJ)		Manual	OPR 05048 (09/90) > 06/98	101160	640/460	2150N0-9622672780 96101674-96226727
AX 1.4i (TU3FJ)		Manual	09/90 > 06/98	101170	680/490	96089335-9608933580
BERLINGO						
BERLINGO (M49) 1.1-1.4-1.6-1.8 Boîte/ Gear box MA	Integrated in the cable	Manual Adjust	06/96 > 10/02	101140	635/340	2150R1-9621451080
		Auto Adjust	06/96 > 10/02	554562	635/340	
BERLINGO (M49) 1.8D 1.9D (XUD9,DW8 & DW8B) & 2.0 HDI (DW10TD) Boîte/ Gear box BE3 & BE3R	Integrated in the cable	Manual Adjust	06/96 > 10/02	101150	667/314	2150R2-9627513880
		Auto Adjust	06/96 > 10/02	101151	665/330	
BERLINGO (M49) 1.8i Boîte/Gear box BE3 & BE3R	Integrated in the cable	Manual Adjust	06/96 > 10/02	101350	660//310	2150V1-9627514180
		Auto Adjust	09/96 > 10/02	101351	660/310	
BERLINGO (M49) 1.6 1.6 16V-1.9D Boîte/ Gear box BE4R	310204	Manual Adjust	06/96 > 10/02	101840	899/687	2150CX-9661239180 2150CF-9648780380 2150CS-9656675180 2150AH-9638424680
		Auto Adjust	06/96 > 10/02	101791	899/687	
BERLINGO (M59) 1.9D 1.6 16V 1.6 HDI 2.0HDI Boîte/Gear box BE4R	310204	Manual Adjust	11/02 > OPR 11189 (06/07)	101840	899/687	2150CX-9661239180 2150CF-9648780380 2150CS-9656675180 2150AH-9638424680
		Auto Adjust	11/02 > OPR 11189 (06/07)	101791	899/687	
BERLINGO (M59) 1.9D-1.6 16V-1.6 HDI- 2.0 HDI Boîte/Gear box BE4R	310204 sauf 2.0HDI	Manual Adjust	OPR 11190 (07/07) >	Not available	899/688	9806892280-2150CY- 9664708080
		Auto Adjust	OPR 11190 (07/07) >	554564	899/689	
CHAPE/BIELETTE POUR PEDALE DE DEBRAYAGE - CLUTCH CABLE LINKAGE						
BERLINGO all model sauf/ except 2.0 HDI 07/07->			09/96 >	310204		212822-9633830686
BERLINGO 2.0 HDI			07/07 >	Not available		212831
BX						
BX 14 (1360cc)		Manual	10/82 > OPR 04192 (04/88)	Not available	460/310	95610155-9559605380 95496081-95496745
BX 14 (1360cc)		Manual	OPR 04193 (05/88) > 12/93	101080	1330/1090	96044602
BX 15 16 17 18 19 all model ess & diesel sauf/except Turbo D GTI 16S & 4X4		Manual	10/82 > 12/93	100970	680/510	95610218-9559605580

Véhicule Vehicle	Réf. chape Cable linkage	Type	Année Year	SEIM P/n	Longueur Length	OE
CITROEN Suite...						
BX Turbo D GTI 16S & 4x4		Manual	10/82 -> 12/93	101050	680/390	95636691
C1						
C1 1.0i		Manual	06/05 ->	101844	1596/1396	2150CQ-313400H030
C1 1.4 HDI		Manual	06/05 ->	101845	1479/1277	2150CR-313400H040
C15						
C15 all model essence		Manual	10/84 -> 05/88 (OPR 03978)	100950	440/242	95493316-9554512380
C15 all model essence 1.1 1.4 & 1.4i (mot TU)		Manual	OPR 04222 (06/88) -> 12/05	101190	670/400	95636976-9563697680
C15 essence 1.1 (Mot E1A) & 1.3 (Mot G1A)		Manual	10/84 -> 12/05	101060	820/610	96019324-9601932480
C15 diesel		Manual	10/84 -> OPR 04496 (02/89)	100990	750/560	95594985-9559498580
C15 diesel		Manual	OPR 04497 (03/89) -> 12/05	101090	690/390	95636991-9563699180
C25						
C25 all model		Manual	09/81 -> 07/90	200150	1180/890	215055
C25 all model		Manual	07/90 -> 06/95	200480	1200/860	215000-2150E2-4460471 7724708-ZF04460471
C35						
C35 all model		Manual	01/73 -> 12/91	100900	2128/1903	5437678
CX						
CX all model 4 vitesses/speed		Manual	05/82 -> 07/83	100980	870/432	95492896
CX all model		Manual	07/85 ->	101000	870/580	95606505
DYANE & ACADIANE						
DYANE & ACADIANE all model		Manual	09/68 -> 12/83	100010	699/515	95494917
EVASION						
EVASION 1.8i & 2.0i 123cv (mot XU10J2) Boîte/Gear box BE3 & BE3R	Integrated in the cable	Manual Adjust	07/94 -> 09/02	200511	770/330	2150S4-1476637080
		Auto Adjust	07/94 -> 09/02	200510	770/330	1479128080
EVASION 2.0i 132cv (mot XU10J4R) Boîte/ Gear box MLST	Integrated in the cable	Manual Adjust	07/94 -> 09/02	200521	1060/725	2150P6-1476128080
		Auto Adjust	07/94 -> 09/02	200520	1090/720	
EVASION 2.0 16V 136cv (mot EW10J4) Boîte/Gear box BE4R	Integrated in the cable	Manual Adjust	07/94 -> 09/02	101780	980/640	2150AC-1487268080
		Auto Adjust	07/94 -> 09/02	101781	973/632	
EVASION 2.0i Turbo Boîte/Gear box ME	Integrated in the cable	Manual Adjust	07/94 -> OPR 07391 (02/97)	101340	870/490	2150T1-1480346080
		Auto Adjust	07/94 -> OPR 07391 (02/97)	101341	840/550	1476638080
EVASION 2.0i Turbo Boîte/Gear box MLST	Integrated in the cable	Manual Adjust	OPR 07392 (05/98) -> 09/02	200521	1060/725	2150P6-1476128080
		Auto Adjust	OPR 07392 (05/98) -> 09/02	200520	1090/720	
EVASION 1.9 Turbo D (XUD9TF & XUD9BTF) Boîte/Gear box ME	Integrated in the cable	Manual Adjust	07/94 -> OPR 07111 (03/96)	101340	870/490	2150T1-1480346080
		Auto Adjust	07/94 -> OPR 07111 (03/96)	101341	840/550	1476638080
EVASION 1.9 Turbo D (XUD9TF & XUD9BTF), 2.1 Turbo D (XUD11BTE) & 2.0HDI (DW10BTE) Boîte/Gear box MLST	Integrated in the cable	Manual Adjust	03/96 -> 09/02	200521	1060/725	2150P6-1476128080
		Auto Adjust	03/96 -> 09/02	200520	1090/720	
GS & GSA						
GS-GSA all model		Manual	11/78 -> 07/86	100500	1165/927	GX4217601A
JUMPER						
JUMPER 2.0i 1.9D 2.5D 2.5TD (emb poussé/pushed clutch) Boîte/Gear box ME		Manual	02/94 -> 02/02	200560	1035/540	2150T5-2150J2 1310131080-1318447080
JUMPER 1.9TD (emb poussé/pushed clutch) Boîte/Gear box ME		Manual	02/94 -> 02/02	200570	1058/520	2150T6-2150J4 1312633080
JUMPER 2.0i 2.5D 2.8D 2.8TD Boîte/ Gear box MLST		Manual	02/94 -> 02/02	101730	1435/910	2150AV-2150Y5 1335052080
JUMPER 2.8D Boîte/Gear box MLGU		Manual	02/94 -> 02/02	554574	1080/645	2150CW-1336432080
JUMPER 1.9 1.9 TD Boîte/Gear box MLST		Manual	02/94 -> 02/02	101843	1478/910	2150AP-2150Z7 1335053080-1321581080
JUMPER 2.0i 2.5D 2.5TD 103 & 107cv Boîte/Gear box MG5T		Manual	02/94 -> 02/02	200580	1090/555	2150T7-2150J3 1310132080-1318446080
JUMPER 2.8TD 2.8HDI (emb tiré/pulled clutch) Boîte/Gear box MG5T		Manual	02/94 -> 31/03/05	200580	1090/555	2150T7-2150J3 1310132080-1318446080
JUMPER 2.8D Boîte/Gear box MLGU 2.8TD 2.8HDI (emb tiré/pulled clutch) Boîte/ Gear box MG5T		Manual	04/05 ->	554574	1080/645	2150CW-1336432080

Véhicule Vehicle	Réf. chape Cable linkage	Type	Année Year	SEIM P/n	Longueur Length	OE
CITROËN Suite...						
JUMPY						
JUMPY 1.6i & 1.9 D (DW8B) Boîte/ Gear box BE3 & BE3R	Integrated in the cable	Manual Adjust	09/95 -> 12/03	200511	770/330	2150S4-1479128080 1476637080
		Auto Adjust	09/95 -> 12/03	200510	770/330	
JUMPY 1.9 D (DW8B) Boîte/ Gear box BE4R	Integrated in the cable	Manual Adjust	01/04 -> 12/06	101780	980/640	2150AC-1487268080
		Auto Adjust	01/04 -> 12/06	101781	973/632	
JUMPY 2.0 16V 136cv (EW10J4) Boîte/ Gear box BE4R	Integrated in the cable	Manual Adjust	09/95 -> 12/06	101780	980/640	2150AC-1487268080
		Auto Adjust	09/95 -> 12/06	101781	973/632	
JUMPY 1.9 Turbo D (XUD9TF & XUD9BTF) Boîte/Gear box ME	Integrated in the cable	Manual Adjust	09/95 -> OPR 07111 (04/96)	101340	870/490	2150T1-1480346080 1476638080
		Auto Adjust	09/95 -> OPR 07111 (04/96)	101341	840/550	
JUMPY 1.9 Turbo D (XUD9TF & XUD9BTF) Boîte/Gear box ML5T	Integrated in the cable	Manual Adjust	OPR 07112 (04/96) -> 12/06	200521	1060/725	2150P6-1476128080
		Auto Adjust	OPR 07112 (04/96) -> 12/06	200520	1090/720	
JUMPY 2.0 HDI Boîte/Gear box ML5C	Integrated in the cable	Manual Adjust	09/95 -> 12/06	200522	1010/660	2150AN-1487725080
		Auto Adjust	09/95 -> 12/06	554565	1003/643	
LN & LNA						
LN & LNA (moteur 602 & 652 cm3)		Manual	76 -> 86	Not available	770/580	5490829
LN & LNA 11E & 11 RE(moteur 1124cm3)		Manual	76 -> 86	100930	434/245	95495608
MEHARI						
MEHARI all model		Manual	09/68 -> 12/83	100010	699/515	95494917
NEMO						
NEMO 1.4i & 1.4HDI sans régulateur de vitesse/without cruise control		Manual	12/07 ->	Not available		2150EA-55216695
SAXO						
SAXO all model avec ou sans direction assistée with and without power steering	Integrated in the cable	Manual	03/96 -> 12/04	200380	680/440	2150Q3-96259810
VISA						
VISA Spécial & Club (mot 652cm3)		Manual	06/80 -> 06/88	100940	824/612	95493315
VISA super. E. L (1124 cm3). X (1219 cm3). 14TRS. GT & Chrono		Manual	09/78 -> 06/80	100420	415/270	75491651
VISA super. E. L (1124 cm3) X (1219cm3). 14TRS. GT & Chrono		Manual	06/80 -> 06/88	100950	440/240	95493316-9549331680 9554512380
VISA GTI & Diesel		Manual	03/84 -> 06/88	100990	750/ 560	95496584
XANTIA						
XANTIA 1.6-1.8i 90cv-1.8i 101cv- 1.8i 16V 110cv	310202	Manual	05/93 -> 06/98	101100	780/490	96097749-9609774980
XANTIA & XANTIA restylé 1.6-1.8i 90cv- 1.8i 101cv-1.8i 16V 110cv Boîte/ Gear box BE3 & BE3R	310202	Manual	05/93 -> 09/02	101100	780/490	96097749-9609774980
XANTIA & XANTIA restylé 2.0i 16V 133cv Boîte/Gear box BE3 & BE3R	310202	Manual	05/93 -> 09/02	101280	840/630	2150P5-9622826380
XANTIA 1.9D 69cv (XUD9) Boîte/ Gear box BE3	310202	Manual	05/93 -> OPR 06747 (05/95)	101100	780/490	96097749-9609774980
XANTIA 1.9D 69cv (XUD9) Boîte/ Gear box BE3	310202	Manual	OPR 06748 (06/95) -> 06/98	101290	780/490	2150AA-9637825880
XANTIA & XANTIA restylé 1.9TD 75cv (XUD9SD) Boîte/Gear box BE3 & BE3R	310202	Manual	05/93 -> 09/02	101290	780/490	2150AA-9637825880
XANTIA & XANTIA restylé 1.9 Turbo D Boîte/ Gear box BE3 & BE3R (câble sans masse/ without metal mass)	310202	Manual	05/93 -> 09/02	101280	840/630	2150P5-9622826380
XANTIA & XANTIA restylé 1.9 Turbo D Boîte/ Gear box BE3 & BE3R (câble avec masse/ with metal mass)	310202	Manual	05/93 -> 09/02	101110	840/630	96108987-9610898780
XANTIA restylé 1.9TD 75cv(XUD9SD) & 2.OHDI Boîte/Gear box BE3 & BE3R	310202	Manual	12/97 -> 09/02	101290	780/490	2150AA-9637825880
CHAPE/BIELETTE POUR PEDALE DE DEBRAYAGE - CLUTCH CABLE LINKAGE						
XANTIA all model			05/93 -> 09/02	310202		212821

Véhicule Vehicle	Réf. chape Cable linkage	Type	Année Year	SEIM P/n	Longueur Length	OE
CITROËN Suite...						
XM						
XM 2.0i & 2.1 D	Integrated in the cable	Manual	07/89 -> 06/94	Not available	870/470	96053897
XM 3.0i V6 & 2.1 Turbo D	Integrated in the cable	Manual	07/89 -> OPR 04958 (05/90)	Not available		96053916
XM 3.0i V6 & 2.1 Turbo D	Integrated in the cable	Manual	OPR 04959 (06/90) -> 06/94	Not available	830/460	96118754
XM & XM II 2.0i Turbo Boîte/ Gear box ME	Integrated in the cable	Manual	OPR 05654 (05/92) -> 03/01	Not available	840/460	96156046
XM II 2.0i (Mot XU10J2) & 2.1 D Boîte/ Gear box BE3	Integrated in the cable	Manual	07/94 -> 03/01	Not available	870/470	96053897
XM II 2.016V Boîte/Gear box BE3 & BE3R	Integrated in the cable	Manual	07/94 -> 03/01	Not available	900/600	2150J9
XM II 2.0 16V & 2.1 Turbo D Boîte/ Gear box ME	Integrated in the cable	Manual	07/94 -> 03/01	Not available	830/460	96118754
XSARA						
XSARA 1.4i 1.5D 1.6i Boîte/Gear box MA	Integrated in the cable	Manual Adjust	07/97 -> 09/00	101140	650/350	2150V7-9625275680
		Auto Adjust	07/97 -> 09/00	101311		
XSARA 1.8i 1.8i16V 1.9TD (75 cv) 1.8D & 1.9D (mot XUD9 & DW8) Boîte/ Gear box BE3 & BE3R	Integrated in the cable	Manual Adjust	07/97 -> 09/00	101150	667/314	2150V9-9625276780
		Auto Adjust	07/97 -> 09/00	101321	665/330	
XSARA 1.9TD (90cv) & 2.0i16V (135 & 167 cv) Boîte/Gear box BE3	Integrated in the cable	Manual Adjust	07/97 -> 09/00	101330	740/500	2150V2-9632112980
		Auto Adjust	07/97 -> 09/00	101331		
XSARA 2.0 HDI (90cv) Boîte/ Gear box BE3R	Integrated in the cable	Manual Adjust	07/97 -> 09/00	Not available		2150Z1-9635304780
		Auto Adjust	07/97 -> 09/00	200621		
XSARA II 1.4i & 1.6i16V Boîte/ Gear box MA	Integrated in the cable	Manual Adjust	09/00 -> 11/04	101140	650/350	2150V7-9625275680
		Auto Adjust	09/00 -> 11/04	101311		
XSARA II 1.4HDI 1.9D 2.0 HDI (90 & 110 cv) 2.0i 16V (137cv) Boîte/Gear box BE4R	310204	Manual Adjust	09/00 -> 11/04	101840	899/687	2150AR-2150Z6
		Auto Adjust	09/00 -> 11/04	101802	909/738	9646122580-9631294180
XSARA II 2.0i 16V (167cv) Boîte/ Gear box BE3R	Integrated in the cable	Manual Adjust	09/00 -> 11/04	101330	740/500	2150V2-9632112980
		Auto Adjust	09/00 -> 11/04	101331		
CHAPE/BIELETTE POUR PEDALE DE DEBRAYAGE - CLUTCH CABLE LINKAGE						
XSARA II 1.4TD 1.9D 2.0 HDI (90 & 110 cv) 2.0i 16V (137cv) Boîte/Gear box BE4R			09/00 -> 11/04	310204		212822
XSARA PICASSO						
XSARA PICASSO all model	310204	Manual Adjust	12/99 ->	101750	905/700	2150AS-9645688880
		Auto Adjust	12/99 ->	101830	895/672	2150Z5-9639789280 2150AT-9645687980
CHAPE/BIELETTE POUR PEDALE DE DEBRAYAGE - CLUTCH CABLE LINKAGE						
XSARA PICASSO all model			12/99 ->	310204		212822
ZX						
ZX 1.1 1.1i 1.4 1.4i 1.4D & 1.5D Boîte/ Gear box MA	310203	Manual	03/91 -> OPR 06567 (11/94)	101130	610/390	2150R7-9610467980
ZX 1.1 1.1i 1.4 1.4i 1.4D & 1.5D Boîte/ Gear box MA	310203	Manual	OPR 06568 (11/94) -> 06/98	101300	640/390	2150N9-9620573680
ZX 1.6i 1.8i 1.9i 2.0i 1.8D & 1.9D Boîte/ Gear box BE3	310203	Manual	03/91 -> OPR 06567 (11/94)	101240	640/380	2150P7-9610468080
ZX 1.6i 1.8i 1.9i 2.0i Boîte/Gear box BE3	310203	Manual	OPR 06568 (11/94) -> 06/98	101230	670/370	2150N8-9620573780
ZX 1.8D & 1.9D Boîte/Gear box BE3	310203	Manual	OPR 06568 (11/94) -> OPR 06748 (05/95)	101230	670/370	2150N8-9620573780
ZX 1.8D & 1.9D Boîte/Gear box BE3	310203	Manual	OPR 06749 (05/95) -> 06/98	101250	690/380	2150P8-9625843280
ZX 1.9TD & 2.0i 16V (sauf/except 167cv)	310203	Manual	03/91 -> OPR 06567 (11/94)	101210	710/530	2150R5-9611029680
ZX 1.9TD & 2.0i 16V (sauf/except 167cv)	310203	Manual	OPR 06568 (11/94) -> OPR 06809 (07/95)	101220	740/530	2150P0-9620573880
ZX 1.9TD & 2.0i 16V (150 155 & 167cv)	310203	Manual	OPR 06810 (07/95) -> 06/98	101260	760/550	2150Q0-9626410180
CHAPE/BIELETTE POUR PEDALE DE DEBRAYAGE - CLUTCH CABLE LINKAGE						
ZX all model				310203		96074781

Véhicule Vehicle	Réf. chape Cable linkage	Type	Année Year	SEIM P/n	Longueur Length	OE
DACIA						
LOGAN & LOGAN MCV						
LOGAN & LOGAN MCV 1.2 16v-1.4MPi-1.6MPi		Manual	06/05 ->	401712	1133/681	6001546867-8200215961
LOGAN & LOGAN MCV 1.6 16v		Manual	06/05 -> 10/08	NEW 555153		6001548445
SANDERO						
SANDERO 1.2 16v-1.4MPi-1.6MPi		Manual	06/08 ->	401712	1133/681	6001546867-8200215961
FIAT						
500 II						
500 II all model 1.2i		Manual	07/07 ->	554569	995/625	55183097-1558930
500 II all model 1.4i 16V		Manual	07/07 ->	554570	1000/625	55210048
500 II 1.3 MJTD		Manual	07/07 ->	554571	1028/625	55196302-1558931
BRAVA & BRAVO						
BRAVA / BRAVO 1.2 & 1.4 12V		Manual	09/94 -> 12/01	701240	940/410	46453539-7770205
BRAVA / BRAVO 1.6 16V & 1.9D		Manual	09/94 -> 06/95	701230	860/350	7771565
BRAVA / BRAVO 1.4 16V 1.6 16V & 1.9D		Manual	06/95 -> 12/01	701250	1475/1065	46797595-46448106 46797579
BRAVA / BRAVO 1.9TD (75 & 100 cv)		Manual	09/94 -> 12/01	554573	1508/1060	46475319-46472971 46467631-46475314
CINQUECENTO						
CINQUECENTO (700cm3)		Manual	07/92 -> 09/98	701090	678/377	7632289
CINQUECENTO (900cm3)		Manual	07/92 -> 09/98	701100	591/272	7680262
CINQUECENTO Sporting (1108cm3)		Manual	07/92 -> 09/98	701190	776/396	46406436
CROMA						
CROMA all model		Manual	05/86 -> N°ch. 0115572	701110	934/660	82424220
CROMA all model		Manual	88 -> 09/96	701120	890/660	82435483
DOBLO						
DOBLO 1.2		Manual	03/01 -> 01/10	701289	732/185	46816591
DUCATO						
DUCATO all model		Manual	09/81 -> 07/90	200150	1180/890	215055
DUCATO all model		Manual	07/90 -> 02/94	200480	1200/860	4460471-7724708 2150E2-ZF04460471
DUCATO 2.0i 1.9D 2.5D 2.5TD (emb poussé/pushed clutch) Boîte/Gear box ME		Manual	02/94 -> 01/02	200560	1035/540	2150T5-2150J2 1310131080-1318447080
DUCATO 1.9TD (emb poussé/pushed clutch) Boîte/Gear box ME		Manual	02/94 -> 01/02	200570	1058/520	2150T6-2150J4 1312633080
DUCATO 2.0i 2.5D 2.8D 2.8TD Boîte/Gear box MLST		Manual	02/94 ->	101730	1435/910	2150AV-2150Y5 1335052080
DUCATO 1.9 1.9 TD Boîte/Gear box MLST		Manual	02/94 ->	101843	1478/910	2150AP-2150Z7 1335053080-1321581080
DUCATO 2.0i 2.5D 2.5TD 103 & 107cv Boîte/Gear box MG5T		Manual	02/94 -> 01/02	200580	1090/555	2150T7-2150J3 1310132080-1318446080
DUCATO 2.8D Boîte/Gear box MLGU		Manual	06/01 ->	554574	1080/645	1336432080-2150CW
DUCATO 2.8TD 2.8HDI (emb tiré/pulled clutch) Boîte/Gear box MG5T		Manual	02/94 -> 31/03/05	200580	1090/555	2150T7-2150J3 1310132080-1318446080
DUCATO 2.8D 2.8TD 2.8HDI (emb tiré/pulled clutch) Boîte/Gear box MG5T & 2.8D Boîte/Gear box MLGU		Manual	Du 01/04/05 ->	554574	1080/645	1336432080-2150CW
FIORINO						
FIORINO all model		Manual	01/88 -> 07/89	701201	650/380	5963181
FIORINO all model		Manual	08/89 -> 05/91	701180	650/350	7515915
FIORINO all model		Manual	06/91 -> 09/95	701290	644/293	7520132-50007676
FIORINO all model		Manual	10/95 -> 97	701291	660/310	7521110
FIORINO all model		Manual	97 -> 98	701292	678/220	50007727
FIORINO all model		Manual	98 -> 01	701293	698/215	50011681
FIORINO II QUBO all model 1.4i & 1.4HDI		Manual	12/07 ->	Not available		2150EA-55216695

Véhicule Vehicle	Réf. chape Cable linkage	Type	Année Year	SEIM P/n	Longueur Length	OE
FIAT						
						<i>Suite...</i>
MAREA						
MAREA 1.2 & 1.4		Manual	09/96 -> 12/02	701240	940/410	46453539-7770205
MAREA 1.6 1.8 1.9D		Manual	09/96 -> 12/02	701250	1475/1065	46797595-46448106 46797579
MAREA 1.9TD 75 cv & 100 cv		Manual	09/96 -> 12/02	554573	1508/1060	46475319-46472971 46467631-46475314
MULTIPLA						
MULTIPLA all model		Manual	01/99 -> 09/08	554575	866/360	46538236
PALIO & SIENA						
PALIO & SIENA include WEEK END 1.2 (75cv)		Manual	-> 04/99	554576	684/193	46558766
PALIO & SIENA include WEEK END 1.2 (75cv)		Manual	04/99 -> 12/02	554577	800/308	46788229
PALIO & SIENA include WEEK END 1.6 16V & 100 16V		Manual	03/98 -> 12/02	554578	678/210	46781018
PALIO & SIENA include WEEK END 1,7 TD		Manual	03/98 -> 12/02	701282	735/230	46740888-46457858
PALIO & SIENA include WEEK END 70 TD		Manual	03/98 -> 12/02	554579	700/205	46740888-46522370 46558765
PALIO & SIENA include WEEK END 1.6 16V & 100 16V		Manual	03/98 -> 12/02	701281	700/205	46459923
PANDA						
PANDA 45 all model		Manual	80 ->	701000	320/520	4406587
PANDA 750 1000 & 4X4		Manual	86 ->	701200	540/350	7555958
PANDA all model (avec/with bosch injection system)		Manual	07/91->Ch.MO 4233955 07/91->Ch.VE 4434756	701080	517/340	7706794
PANDA all model (avec/with weber injection system)		Manual	Ch.MO 4233955-> 08/03 Ch.VE 4434756 ->08/03	701283	580/360	7702089
PANDA II 1.1 1.2 1.3 MJTD & 4X4		Manual	09/03->Ch.0178817	554569	995/625	55183097-1558930
PANDA II 1.1 1.2 1.3 MJTD & 4X4		Manual	Ch.0178817->	554571	1028/625	55196302-1558931
PUNTO						
PUNTO 55 60 75		Manual	11/93 -> 02/94	701130	832/450	7735823-7798973
PUNTO 55 60 75 90 & D		Manual	07/94 -> 11/96	701210	854/211 +103	46437478
PUNTO all model sauf/except TD		Manual	12/96 ->	701220	856/211 +103	46461939-46451736 7780036-46469621
PUNTO GT & TD		Manual	11/93 -> 07/96	701140	700/330	7738397-7780034
PUNTO TD		Manual	07//96 -> 11/96	701220	856/211 +103	46461939-46451736 7780036-46469621
PUNTO TD		Manual	12/96 -> 09/99	554580	700/210	46461941
QUBO						
QUBO 1.4i & 1.3 MJTD		Manual	12/07 ->	Not available		2150EA-55216695
RITMO						
RITMO all model diesel		Manual	10/82 -> 12/84	Not available	890/610	7536184
RITMO all model diesel & TD		Manual	01/85 ->	701285	600/370	7559911
RITMO all model essence/gasoline		Manual	01/85 ->	701284	620/370	7556324-7542416 7556324
SCUDO						
SCUDO 1.6i & 1.9 D (DW8B) Boîte/ Gear box BE3 & BE3R	Integrated in the cable	Manual Adjust	02/96 -> 12/03	200511	770/330	2150S4-1476637080 1479128080
		Auto Adjust	02/96 -> 12/03	200510	770/330	
SCUDO 1.9 D (DW8B) Boîte/ Gear box BE4R	Integrated in the cable	Manual Adjust	01/04 -> 12/06	101780	980/640	2150AC-1487268080
		Auto Adjust	01/04 -> 12/06	101781	973/632	
SCUDO 2.0i 16v 136cv (Mot RFN) Boîte/ Gear box BE4R	Integrated in the cable	Manual Adjust	02/96 -> 12/06	101780	980/640	2150AC-1487268080
		Auto Adjust	02/96 -> 12/06	101781	973/632	
SCUDO 1.9 Turbo D (XUD9TF & XUD9BTF) Boîte/Gear box ME	Integrated in the cable	Manual Adjust	02/96 -> OPR 07111 (04/96)	101340	870/490	2150T1-1480346080 1476638080
		Auto Adjust	02/96 -> OPR 07111 (04/96)	101341	840/550	
SCUDO 1.9 Turbo D (XUD9TF & XUD9BTF) Boîte/Gear box ML5T	Integrated in the cable	Manual Adjust	OPR 07112 (04/96)-> 12/06	200521	1060/725	2150P6-1476128080
		Auto Adjust	OPR 07112 (04/96)-> 12/06	200520	1090/720	
SCUDO 2.0 JTD Boîte/Gear box ML5C	Integrated in the cable	Manual Adjust	09/95 -> 12/06	200522	1010/660	2150AN-148725080
		Auto Adjust	09/95 -> 12/06	554565	1003/643	

Véhicule Vehicle	Réf. chape Cable linkage	Type	Année Year	SEIM P/n	Longueur Length	OE
FIAT						
SEICENTO						
SEICENTO (900cm3)		Manual	03/98 ->	701100	591/272	7680262
SEICENTO Sporting (1108cm3)		Manual	03/98 ->	701190	776/396	46406436
TIPO & TEMPRA						
TIPO/TEMPRA all model sauf/except TD		Manual	05/88 -> 02/96	701070	700/340	7674443-7610378
TIPO/TEMPRA TD		Manual	05/88 -> 02/96	701150	760/350	7670999-7649509
ULYSSE						
ULYSSE 1.8i & 2.0i 123cv (Mot RFU) Boîte/ Gear box BE3 & BE3R	Integrated in the cable	Manual Adjust	07/94 -> 09/02	200511	770/330	2150S4-1476637080 1479128080
		Auto Adjust	07/94 -> 09/02	200510	770/330	
ULYSSE 2.0 16V 132cv (Mot RFV) Boîte/ Gear box ML5T	Integrated in the cable	Manual Adjust	07/94 -> 09/02	200521	1060/725	2150P6-1476128080
		Auto Adjust	07/94 -> 09/02	200520	1090/720	
ULYSSE 2.0 16V 136cv (Mot RFN) Boîte/ Gear box BE4R	Integrated in the cable	Manual Adjust	07/94 -> 09/02	101780	980/640	2150AC-1487268080
		Auto Adjust	07/94 -> 09/02	101781	973/632	
ULYSSE 2.0i Turbo Boîte/Gear box ME	Integrated in the cable	Manual Adjust	07/94 -> OPR 07391 (02/97)	101340	870/490	2150T1-1480346080- 1476638080
		Auto Adjust	07/94 -> OPR 07391 (02/97)	101341	840/550	
ULYSSE 2.0i Turbo Boîte/Gear box ML5T	Integrated in the cable	Manual Adjust	OPR 07392 (05/98) > 09/02	200521	1060/725	2150P6-1476128080
		Auto Adjust	OPR 07392 (05/98) > 09/02	200520	1090/720	
ULYSSE 1.9 Turbo D (XUD9TF&XUD9BTF) Boîte/Gear box ME	Integrated in the cable	Manual Adjust	07/94 -> OPR 07111 (03/96)	101340	870/490	2150T1-1480346080 1476638080
		Auto Adjust	07/94 -> OPR 07111 (03/96)	101341	840/550	
ULYSSE 1.9 (XUD9TF & XUD9BTF), 2.1 Turbo D (XUD11BTE) & 2.0JTD (mot DW10BTE) Boîte/Gear box ML5T	Integrated in the cable	Manual Adjust	03/96 -> 09/02	200521	1060/725	2150P6-1476128080
		Auto Adjust	03/96 -> 09/02	200520	1090/720	
UNO						
UNO all model		Manual	05/83 -> 10/89	701050	630/320	7592915-4444079
UNO all model sauf/except 1.4D (1367 cm3)		Manual	10/89 -> 05/93	701160	700/340	7679548
UNO 1.4D (1367cm3)		Manual	10/89 -> 05/93	Not available	630/320	7709460
UNO all model sauf/except 900 1000 1100cm3 & TREND		Manual	06/93 ->	701288	800/430	7727939
UNO 1.7D		Manual	juin-93	701299	640/360	7781087

FORD						
ESCORT						
ESCORT III all model		Manual	08/80 -> 83	600160	1210/950	6091957-6139192 81AB7K553DB
ESCORT III all model		Manual	83 -> 04/86	600480	1380/1100	6140343-83AB7K553AA
ESCORT IV & ORION I all model		Manual	04/86 -> 08/90	600490	740/475	6166128-6082434
ESCORT V & ORION II all model sauf/ except ABS & 2.0 16v		Manual	08/90 -> 09/95	600500	785/447	6575413-91AB7K553AD
ESCORT V & ORION II all model avec/ with ABS sauf/except 2.0 16v		Manual	08/90 -> 09/95	600550	1010/700	6492352-91AB7K553EA
ESCORT V & ORION II 2.0 16v		Manual	08/90 -> 06/94	600633	803/465	1038239-6789186 94AB7K553FB
ESCORT V & ORION II 2.0 16v		Manual	06/94 -> 01/95	600635	860/450	1038241-94AB7K553HC
ESCORT V & ORION II all model Essence/ gasoline & Diesel mot ZETEC. avec/with ABS		Manual	06/92 -> 01/95	600670	790/480	6900281-6779976
ESCORT V 2.0 RS		Manual	06/92 -> 01/95	Not available	1380/1080	6514375
ESCORT V & VI COSWORTH 4x4		Manual	09/92 -> 10/98	Not available	1960/1660	6514374
ESCORT VI all model Essence sauf/ except mot ZETEC		Manual	09/95 -> 07/96	600632	786/465	1016071-94AB7K553AB
ESCORT VI all model Essence sauf/ except mot ZETEC		Manual	07/96 ->	600634	793/465	1038238-94AB7K553AC
ESCORT VI all model 1.3i 1.4i 1.6 16v 1.8 D		Manual	09/95 ->	600633	803/465	1038239-6789186 94AB7K553FB
ESCORT VI all model 1.8 D & 1.8 16V sauf/ except Boîte/Gear box MTX 75		Manual	01/95 -> 01	600633	803/465	1038239-6789186 94AB7K553FB

Véhicule Vehicle	Réf. chape Cable linkage	Type	Année Year	SEIM P/n	Longueur Length	OE
FORD						
<i>Suite...</i>						
ESCORT VI all model 1.8 16V avec/ with Boîte/Gear box MTX 75		Manual	01/95 -> 01	600635	860/450	1038241-94AB7K553HC
ESCORT VI 1.8 Turbo Diesel & COSWORTH		Manual	01/95 ->	600635	860/450	1038241-94AB7K553HC
KIT CREMAILLERE DE DEBRAYAGE - CLUTCH PEDAL KIT						
ESCORT ORION all model			-> 89	320200		61994025
ESCORT ORION all model			89 -> 95	320201		61830026-6183031
ESCORT ORION all model			95 ->	320204		7333649-7333650
FIESTA						
FIESTA I & II + COURRIER all model sans servo frein/without brake servo		Manual	76 -> 89	600530	670/430	6109041-666678 6046205
FIESTA I & II + COURRIER all model avec servo frein/with brake servo		Manual	76 -> 89	600510	670/430	6066679-6046206 6143701
FIESTA III & COURRIER all model		Manual	89 -> 12/93	600400	650/370	6174503-6612561
FIESTA III & COURRIER all model		Manual	01/94 -> 12/95	600540	646/360	6900282
KIT CREMAILLERE DE DEBRAYAGE - CLUTCH PEDAL KIT						
FIESTA all model			-> 89	320200		6186200
FIESTA all model			89->	320202		6189055
FIESTA COURRIER all model			85 -> 95	320202		6180329
KA						
KA II 1.2		Manual	10/08 ->	554569	995/625	55183097-1558930
KA II 1.3 JTD		Manual	10/08 ->	554571	1028/625	55196302-1558931
MONDEO						
MONDEO 1.8i:2.0i & 1.8TD all model		Manual	01/93 -> 09/96	600580	740/410	7105817
KIT CREMAILLERE DE DEBRAYAGE - CLUTCH PEDAL KIT						
MONDEO			01/93 -> 09/96	320203		6706221
SCORPIO						
SCORPIO 1.8-2.0:2.0i		Manual	07/85 ->	600640	1400/1100	6153882-85GB7K553AA 6153883-85GB7K553BA
SCORPIO 2.3-2.6-2.8		Manual	07/85 ->	Not available	1286/980	6156055
SCORPIO all model DIESEL		Manual	07/85 -> 87	600270	1410/1060	6122136-83BB7K553GC
SCORPIO all model DIESEL		Manual	88 -> 02/92	600590	1400/1070	6608691-6191953
SIERRA						
SIERRA 1.3 1.6 type E 4 vitesses/speed		Manual	84 ->	600300	1151/880	6142026
SIERRA 1.8 & 2L		Manual	84 -> 87	600560	1380/1090	1629947-83BB7K553EF
SIERRA 1.8 & 2L		Manual	87 -> 90	Not available	1515/1200	6166222
SIERRA 1.8 & 2L		Manual	90 ->	600570	1520/1230	1647679
SIERRA all model Diesel		Manual	84 ->	600270	1410/1060	6122136
SIERRA all model Diesel		Manual	87 -> 90	600310	1375/1060	6156056
KIT CREMAILLERE DE DEBRAYAGE - CLUTCH PEDAL KIT						
SIERRA				320202		6180329
TRANSIT						
TRANSIT DIESEL		Manual	09/78 -> 86	600520	1280/1045	6046700-78VB7K553DIA
TRANSIT DIESEL		Manual	11/85 -> 07/94	600280	1370/1120	6161414-6177410
TRANSIT 1.6 & 2.0		Manual	11/85 -> 07/94	600600	1140/880	6156501-6158521
TRANSIT 2.0		Manual	08/94->	600650	1542/1105	1086288-1011805
TRANSIT 2.5L D TD		Manual	08/94->	600620	1500/1130	1011806-7343294 96VB7K553CA
KIT CREMAILLERE DE DEBRAYAGE - CLUTCH PEDAL KIT						
TRANSIT all model				320201		61830026-6183031
HYUNDAI						
ATOS & ATOS PRIME						
ATOS 1.0 & ATOS PRIME		Manual	98 ->	554581	794/595	415100210

Véhicule Vehicle	Réf. chape Cable linkage	Type	Année Year	SEIM P/n	Longueur Length	OE
---------------------	-----------------------------	------	---------------	-------------	--------------------	----

IVECO

NEW DAILY

NEW DAILY 35.8 49.10 49.11 GD		Manual	96 >	701271	1940/1610	93820874
-------------------------------	--	--------	------	--------	-----------	----------

KIA

PICANTO

PICANTO all model		Manual	03/04 >	554582	840/610	4151007110
-------------------	--	--------	---------	--------	---------	------------

LADA

SAMARA & SAGONA

SAMARA & SAGONA all model		Manual	> 87	721180	720/480	21081602210
SAMARA & SAGONA all model		Manual	87 > 08/95	Not available	735/480	21091602210
SAMARA & SAGONA all model		Manual	08/95 >	721119	690/470	21101602210

LANCIA

Y-Y10 & YPSILON

Y10		Manual	05/90 > 92	701294	630/310	7704066
Y10 sauf/except 4x4		Manual	92 > 93	Not available	760/372	7715102
Y10 sauf/except 4x4		Manual	94 >	701295	760/410	7786996
Y/ YPSILON		Manual	96 >	701296	860/450	46451736-46469621- 46461939

ZETA

ZETA 1.8i & 2.0i 123cv (Mot RFU) Boîte/ Gear box BE3 & BE3R	Integrated in the cable	Manual Adjust	07/94 > 09/02	200511	770/330	2150S4-1476637080
		Auto Adjust	07/94 > 09/02	200510	770/330	1479128080
ZETA 2.0 16V 132cv (Mot RFV) Boîte/ Gear box ML5T	Integrated in the cable	Manual Adjust	07/94 > 09/02	200521	1060/725	2150P6-1476128080
		Auto Adjust	07/94 > 09/02	200520	1090/720	
ZETA 2.0 16V 136cv (Mot RFN) Boîte/ Gear box BE4R	Integrated in the cable	Manual Adjust	07/94 > 09/02	101780	980/640	2150AC-1487268080
		Auto Adjust	07/94 > 09/02	101781	973/632	
ZETA 2.0i Turbo Boîte/Gear box ME	Integrated in the cable	Manual Adjust	07/94 > OPR 07391 (02/97)	101340	870/490	2150T1-1480346080
		Auto Adjust	07/94 > OPR 07391 (02/97)	101341	840/550	1476638080
ZETA 2.0i Turbo Boîte/Gear box ML5T	Integrated in the cable	Manual Adjust	OPR 07392 (05/98) > 09/02	200521	1060/725	2150P6-1476128080
		Auto Adjust	OPR 07392 (05/98) > 09/02	200520	1090/720	
ZETA 1.9 Turbo D (XUD9TF & XUD9BTF) Boîte/Gear box ME	Integrated in the cable	Manual Adjust	07/94 > OPR 07111 (03/96)	101340	870/490	2150T1-1480346080
		Auto Adjust	07/94 > OPR 07111 (03/96)	101341	840/550	1476638080
ZETA 1.9 Turbo D (XUD9TF & XUD9BTF), 2.1 Turbo D (XUD11BTE) & 2.0JTD (mot DW10BTE) Boîte/Gear box ML5T	Integrated in the cable	Manual Adjust	03/96 > 09/02	200521	1060/725	2150P6-1476128080
		Auto Adjust	03/96 > 09/02	200520	1090/720	

MAZDA

323

323 all model		Manual	10/85 >	735200	765/540	BF6741150C
---------------	--	--------	---------	--------	---------	------------

MERCEDES

MB 100-130-150

MB 100		Manual	09/87 >	352000	1450/1000	6312930238 6312930638
MB 130 150		Manual		352001	1510	6312930038

NISSAN

ALMERA

ALMERA I (N15) 1.4 & 1.6		Manual	10/95 > 03/00	710101		307701M200-307702M115
ALMERA I (N15) 2.0 GTI		Manual	10/95 > 04/98	710103		307701M800

Véhicule Vehicle	Réf. chape Cable linkage	Type	Année Year	SEIM P/n	Longueur Length	OE
NISSAN						
KUBISTAR						
KUBISTAR 1.2		Manual	07/03 ->	401550	960/670	3067000QAC-3067000GOE 7700417050
KUBISTAR 1.5 DCI		Manual	07/03 ->	401690	954/667	3067000QAD-3067000GOC 8200098019
MICRA						
MICRA all model		Manual	10/82 -> 10/92	710200	625/420	3067005B00
MICRA all model		Manual	10/92 -> 04/98	710100	625/410	307705F200
MICRA all model sauf/except 1.5D		Manual	04/98->	554583	655/400	307706F610
MICRA 1.5D		Manual	04/98->12/00	Not available		307706F801
PIXO						
PIXO all model		Manual	06/09 ->	554584	665/420	306804A00B-23710M68K01
PRIMERA						
PRIMERA 1.6		Manual	10/90 -> 09/96	710205	735/530	3077099J11
PRIMERA 2.0		Manual	10/90 -> 09/96	710206	695/480	3077097J10
PRIMERA 2.0 GT		Manual	10/90 -> 09/96	710207	720/500	3077094J10
PRIMERA 1.6 GX SIX 2.0 SIX 2.0GT		Manual	10/96 -> 09/99	710208	722/480	307702F221-307702F015
PRIMERA 2.0		Manual	10/96 -> 09/99	710209	720/505	307702F216
PRIMERA Break (W10) 1.6 IX		Manual	10/90 -> 10/96	710210	765/510	3077081N05-3077081N00
PRIMERA Break (W10) avec/with ABS		Manual	10/90 -> 10/96	710211	765/485	3077083N00-3077083N05
SUNNY						
SUNNY (B11)		Manual	86 -> 10/88	Not available	770/552	3077060A01
SUNNY (B11) all model		Manual	10/88 -> 12/91	710201	770/560	3077065A00-3077084A00
SUNNY (N14) 1.4 1.6 2.0 2VVD		Manual	02/91 -> 12/95	710202	723/498	3077062Y01-307709B400
SUNNY (N14) 2.0		Manual	12/95 ->	710204	725/500	3077064Y01-307709B410
OPEL						
AGILA						
AGILA 1.0 1.2 16V		Manual	08/00 ->Ch 4G064595	650441	690/425	4705606-4705607 9206557-9210079
AGILA 1.0 1.2 16V		Manual	Ch. 4G064596-> 12/07	554585		2371083E41-4707843 9216431
AGILA 1.2 12V		Manual	08/00 -> 12/07	554586	627/355	4707942-55555830
AGILA 1.3CDTI		Manual	08/00 -> 12/07	554587	660/355	4707845-9216434
AGILA II 1.1i & 1.2i		Manual	03/08 ->	554588	716/432	4709651-93195010
ASCONA						
ASCONA (C) all model		Manual	09/81 -> 08/83	650100	795/521	669124-90157009
ASCONA (C) all model		Manual	09/83 ->	650260	795/520	669136-90193980
ASTRA						
ASTRA (F) all model		Manual	10/91 -> 06/94	650431	820/486	669142-90209335
ASTRA (F) 1.4 1.6 1.8 1.7D & TD ch.6000001->		Manual	Ch.6000001-> 09/98	650350	815/520	669189-90522146
ASTRA (F) 1.4 16v -1.6 16v-1.7D Ecoturbo 1.8 16v & 2.0 16v		Manual	Ch.T 5000001 -> 09/98 Ch.T 6000001-> 09/98 Ch.T 8000001-> 09/98 Ch.T 2500001-> 09/98 Ch.T P000001-> 09/98	650420	900/530	669003-90522995- 669005-90523132
CALIBRA						
CALIBRA 2.0 & 2.5V6		Manual	01/90 -> 06/97	650280	830/540	669166-90344249
CORSA						
CORSA (A) all model		Manual	82 -> 03/93	650210	693/348	669132-669157
CORSA (B) all model		Manual	03/93 -> 04/97	650370	727/417	669186-90446929
CORSA (B) all model sauf/except 1.4 avec/ with air conditioning & 1.0 12v		Manual	04/97 -> 10/00	650400	794/410	669187-90522447
CORSA (B) 1.0 12v		Manual	04/97 -> 10/00	650430	841/414	669019-90578482
CORSA (B) 1.4 avec/with air conditioning		Manual	04/97 -> 10/00	650440	823/412	669002-90522980

Véhicule Vehicle	Réf. chape Cable linkage	Type	Année Year	SEIM P/n	Longueur Length	OE
OPEL Suite...						
KADETT						
KADETT (C) & (D) all model		Manual	-> 81	Not available		
KADETT (D) all model		Manual	81 -> 07/84	650100	795/521	669124-90157009
KADETT (E) all model		Manual	07/84 -> 10/91	650431	820/520	669142-90209335
VECTRA						
VECTRA (A) 1.8-2.0-2.5V6 & 2.0D		Manual	09/88 -> 06/95	650280	830/540	669166-90344249
VECTRA (A) 1.4-1.6-1.7D & TD		Manual	09/88 -> 06/95	650443	830/550	669170-669161 90334416-90345229
PEUGEOT						
104						
104 all model		Manual	01/76 -> 09/76	200000	452/243	215033
104 all model		Manual	09/76 -> 07/80	200010	420/250	215039
104 all model		Manual	07/80 -> 06/88	200160	470/250	215051
106						
106 1.0 & 1.1 carbu 1.0i-1.1i-1.3i & 1.5D sans direction assistée/without power steering	Integrated in the cable	Manual	09/91 -> 03/96	200340	640/460	2150E0-9612192480
106 1.4 carbu 1.4i-1.4D-1.5D-1.6 90cv sans direction assistée/without power steering	Integrated in the cable	Manual	09/91 -> 03/96	200350	1280/1090	2150C9
106 1.6 90cv avec/with air conditioning & sans direction assistée/without power steering	Integrated in the cable	Manual	09/91 -> 03/96	200380	680/440	2150Q3-9625981080 2150L8-9622954180
106 all model avec direction assisté/with power steering	Integrated in the cable	Manual	09/91 -> 03/96	200380	680/440	2150Q3-9625981080 2150L8-9622954180
106 restylé sans direction assistée/without power steering Boîte/Gear box MA & MAS	Integrated in the cable	Manual	04/96 -> 09/03	200380	680/440	2150Q3-9625981080 2150L8-9622954180
106 restylé sans direction assistée/without power steering Boîte/Gear box MA & MAS	Integrated in the cable	Manual Adjust	04/96 -> 09/03	200600	1340/1160	2150Q5-9625412480
		Auto Adjust	04/96 -> 09/03	200770	1340/1210	
106 restylé 1.1i (TU1M+) 1.4 carbu-1.4i-1.6i-1.5D (TUD5) avec direction assisté/with power steering Boîte/Gear box MA & MAS	Integrated in the cable	Manual Adjust	04/96 -> OPR 08940 (05/01)	200610	1460/1280	2150Q6-9625412580
		Auto Adjust	04/96 -> OPR 08940 (05/01)	200791	1460/1320	
106 restylé 1.0 1.1i 1.4i 1.6i 1.5D (TUD5 & TUD5B) avec direction assisté/with power steering Boîte/Gear box MA & MAS	Integrated in the cable	Manual	OPR 08941 (06/01) -> 09/03	200380	680/440	2150Q3-9625981080 2150L8-9622954180
107						
107 1.0	Integrated in the cable	Manual	06/05 ->	101844	1596/1396	2150CQ-313400H030
107 1.4 HDI	Integrated in the cable	Manual	06/05 ->	101845	1479/1277	2150CR-313400H040
205						
205 mot avec/with carbu 1.0 (XV8) 1.1 (XV) 1.4 (XY7 & XY8) Boîte/Gear box BH3 (4 & 5 vitesses/speed)		Manual	03/83 -> 07/87	200170	440/245	215059
205 mot avec/with carbu 1.0 (XV8) 1.1 (XV) 1.4 (XY7 & XY8) Boîte/Gear box BE1		Manual	03/83 -> 07/88	200260	790/620	215068-215060 9751811480
205 mot avec/with carbu 1.0 (XV8) 1.1 (XV) 1.4 (XY7 & XY8) Boîte/Gear box BE1		Manual	08/88 -> 06/90	200330	790/620	215089
205 1.0 mot TU9 1.1 mot TU1 1.4 Mot TU3 Boîte/Gear box MA	Pince/clamp	Manual	03/83 -> 07/88	200270	630/410	215085
205 1.0 mot TU9 1.1 mot TU1 Boîte/Gear box MA	Pince/clamp	Manual	07/88 -> 07/89	200230	630/420	215091-9604053080
205 1.0 mot TU9 1.1 mot TU1 & 1.1i mot TU1M Boîte/Gear box MA		Manual	07/89 -> 12/98	200280	630/390	2150A8-9605079780
205 1.3 RALLYE & 1.4 mot TU3S Boîte/Gear box MA		Manual	03/83 -> 07/88	200290	1280/1050	215088
205 1.3 RALLYE 1.4 mot TU3 TU3A & TU3S 1.4i TU3M Boîte/Gear box MA		Manual	07/88 -> 07/89	200640	1285/1025	215093-9604052980

Véhicule Vehicle	Réf. chape Cable linkage	Type	Année Year	SEIM P/n	Longueur Length	OE
PEUGEOT						
						<i>Suite...</i>
205 1.3 RALLYE 1.4 mot TU3 TU3A & TU3S 1.4i TU3M Boîte/Gear box MA		Manual	07/89 -> 12/98	200300	1275/1025	2150C0-9605128980
205 1.6 1.6i GT GTI XS 1.9 GTI 1.8D moteur XU Boîte/Gear box BE1		Manual	03/83 -> 07/88	200180	720/520	215071
205 1.6 1.6i GT GTI XS 1.9 GTI 1.8D moteur XU Boîte/Gear box BE1		Manual	08/88 -> 06/90	200250	730/510	215096-9603506880
205 1.6 1.6i GT GTI XS 1.9 GTI 1.8D/ TD 1.9D Boîte/Gear box BE3	Pince/clamp	Manual	10/83 -> 07/90	200310	660/390	2150A1-9604779980
205 1.6 1.6i GT GTI XS 1.9 GTI 1.8D/ TD 1.9D Boîte/Gear box BE3 & BE3R	Pince/clamp	Manual	07/90 -> 12/98	200320	660/390	2150A6-9605079580
206						
206 & 206 SW 1.1i 1.4i 1.6i 90cv & 1.6i 110cv Boîte/Gear box MA	Integrated in the cable	Manual Adjust	09/98 -> OPR 09456 (09/02)	200740	690/380	2150X3-9625227980
		Auto Adjust	09/98 -> OPR 09456 (09/02)	200741	637/404	
206 & 206 SW 1.1i 1.4i & 1.6i 110cv Boîte/Gear box MA	310205	Manual Adjust	OPR 09457 (10/02) -> OPR 09921 (01/04)	Not available		2150AX-9633433180
		Auto Adjust	OPR 09457 (10/02) -> OPR 09921 (01/04)	554664		
206 & 206 SW 1.1i 1.4i & 1.6i 110cv Boîte/Gear box MA	310205	Manual Adjust	OPR 09922 (01/04) -> OPR 11744 (01/09)	200550	690/380	2150EC-9686559280 2150CK-9652759680
		Auto Adjust	OPR 09922 (01/04) -> OPR 11744 (01/09)	200551	560/400	
206+ 1.1i 1.4i & 1.6i	310205	Manual Adjust	03/09 ->	200550	690/380	2150EC-9686559280 2150CK-9652759680
		Auto Adjust	03/09 ->	200551	560/400	
206 2.0i 16v 136cv Boîte/Gear box BE4	Integrated in the cable	Manual Adjust	09/98 -> OPR 09426 (08/02)	200760	940/630	2150Y6-9634309980
		Auto Adjust	09/98 -> OPR 09426 (08/02)	200761	910/610	
206 2.0i 16v 136cv Boîte/Gear box BE4	Integrated in the cable	Manual Adjust	OPR 09427 (09/02) -> OPR 09457 (10/02)	200750	940/630	2150X4-9625239480
		Auto Adjust	OPR 09427 (09/02) -> OPR 09457 (10/02)	200751	920/670	
206 2.0i 16v 136 cv Boîte/Gear box BE4	310205	Manual Adjust	OPR 09458 (10/02) -> 09482 (10/02)	200910	860/630	2150AY-9633433280
		Auto Adjust	OPR 09458 (10/02) -> 09482 (10/02)	200911	840/660	
206 2.0i 16v 136 cv & RC 177cv Boîte/Gear box BE4	310205	Manual Adjust	OPR 09483 (11/02) -> OPR 09921 (01/04)	200650	870/610	2150AZ-9646323580 E074396
		Auto Adjust	OPR 09483 (11/02) -> OPR 09921 (01/04)	200651	840/670	
206 2.0i 16v 136 cv & RC 177cv Boîte/Gear box BE4	310205	Manual Adjust	OPR 09922 (01/04) -> 03/09	Not available		2150EE-9686559480 2150CH-9652759480
		Auto Adjust	OPR 09922 (01/04) -> 03/09	200731	840/650	
206 & 206 SW 1.4HDI Boîte/Gear box BE4	Integrated in the cable	Manual Adjust	09/98 -> OPR 09457 (09/02)	200760	940/630	2150Y6-9634309980
		Auto Adjust	09/98 -> OPR 09457 (09/02)	200761	910/610	
206 & 206 SW 1.4HDI Boîte/Gear box BE4	310205	Manual Adjust	OPR 09458 (11/02) -> OPR 09921 (01/04)	200650	870/610	2150AZ-9646323580 E074396
		Auto Adjust	OPR 09458 (11/02) -> OPR 09921 (01/04)	200651	840/670	
206 & 206 SW 1.4HDI Boîte/Gear box BE4	310205	Manual Adjust	OPR 09922 (01/04) -> 03/09	Not available		2150EE-9686559480 2150CH-9652759480
		Auto Adjust	OPR 09922 (01/04) -> 03/09	200731	840/650	
206+ 1.4 HDI	310205	Manual Adjust	03/09 ->	Not available		2150EE-9686559480 2150CH-9652759480
		Auto Adjust	03/09 ->	200731	840/650	
206 1.9D (DW8 & DW8B) Boîte/Gear box BE4	Integrated in the cable	Manual Adjust	09/98 -> OPR 09456 (09/02)	200750	940/630	2150X4-9625239480
		Auto Adjust	09/98 -> OPR 09456 (09/02)	200751	920/670	
206 1.9D (DW8B) Boîte/Gear box BE4	310205	Manual Adjust	OPR 09457 (10/02) -> OPR 10151 (08/04)	200910	860/630	2150AY-9633433280
		Auto Adjust	OPR 09457 (10/02) -> OPR 10151 (08/04)	200911	840/660	
206 1.9D (DW8B) Boîte/Gear box BE4	310205	Manual Adjust	OPR 10151 (08/04) -> 03/08	Not available		2150EG-9686559380 2150CT-9652759580
		Auto Adjust	OPR 10151 (08/04) -> 03/08	554668		

Véhicule Vehicle	Réf. chape Cable linkage	Type	Année Year	SEIM P/n	Longueur Length	OE
PEUGEOT <i>Suite...</i>						
206 & 206SW 2.0HDI Boîte/ Gear box BE4	Integrated in the cable	Manual Adjust	09/98 -> OPR 09456 (09/02)	200760	940/630	2150Y6-9634309980
		Auto Adjust	09/98 -> OPR 09456 (09/02)	200761		
206 & 206SW 2.0HDI Boîte/ Gear box BE4	310205	Manual Adjust	OPR 09457 (10/02) -> OPR 09945 (01/04)	200650	870/610	2150AZ-9646323580 E074396
		Auto Adjust	OPR 09457 (10/02) -> OPR 09945 (01/04)	200651	840/670	
206 & 206SW 2.0HDI Boîte/ Gear box BE4	310205	Manual Adjust	OPR 09946 (01/04) -> 03/09	Not available	840/650	2150EE-9686559480
		Auto Adjust	OPR 09946 (01/04) -> 03/09	200731		2150CH-9652759480
CHAPE/BIELETTE POUR PEDALE DE DEBRAYAGE - CLUTCH CABLE LINKAGE						
Chape/Biellette 206 all model				310205		212830
304						
304 all model		Manual		200100	900/710	215045
305						
305 all model		Manual	07/77 -> 07/82	200100	900/710	215045
305 all model avec direction assisté / with power steering		Manual	07/82 -> 06/89	200120	740/520	215061
305 all model sans direction assisté/ without power steering		Manual	07/82 -> 06/89	Not available		215057
306						
306 1.1i-1.4i-1.6i Boîte/Gear box MA	Integrated in the cable	Manual	02/93 -> 11/94	200360	676/380	2150E9-9615607680
306 & 306 break/SW 1.1i-1.4i-1.4 GPL- 1.6i Boîte/Gear box MA	Integrated in the cable	Manual Adjust	12/94 -> 03/02	200360	676/380	2150H1-9619147580
		Auto Adjust	12/94 -> 03/02	200361	642/365	
306 & 306 break/SW 1.8i & 1.8D Boîte/ Gear box BE3	Integrated in the cable	Manual Adjust	02/93 -> 04/97	200620	680/340	2150Y1-9634114380
		Auto Adjust	02/93 -> 04/97	200370	660/390	2150L5-9622137780 2150W9-9632326980
306 & 306 break/SW 1.9D & 2.0i (123cv) Boîte/Gear box BE3	Integrated in the cable	Manual Adjust	02/93 -> 04/97	200620	680/340	2150Y1-9634114380
		Auto Adjust	02/93 -> 04/97	200370	660/390	2150L5-9622137780 2150W9-9632326980
306 & 306 break/SW 1.9 TD & 2.016S 150 & 167cv Boîte/Gear box BE3 & BE3R	Integrated in the cable	Manual Adjust	02/93 -> OPR 08336 (09/99)	200630	740/500	2150Y2-9634114180
		Auto Adjust	02/93 -> OPR 08336 (09/99)	554595	725/495	2150X0-9632326780
306 II & 306 II break/SW 1.9 TD & 2.016S (150 & 167cv) Boîte/Gear box BE3R	310204	Manual Adjust	OPR 08337 (09/99) -> 03/02	200710	670/540	2150Y9-9634729480
		Auto Adjust	OPR 08337 (09/99) -> 03/02	200711	694/513	
306 & 306 break/SW 1.8i (103cv) 1.8i 16s 1.8D (XUD7) 1.9D (XUD9 & DW8) & 2.0HDI Boîte/Gear box BE3 & BE3R	Integrated in the cable	Manual Adjust	04/97 -> OPR 08336 (09/99)	200620	680/340	2150Y1-9634114380
		Auto Adjust	04/97 -> OPR 08336 (09/99)	200370	660/390	2150L5-9622137780 2150W9-9632326980
306 II 1.8i (103cv) 1.8i 16s 1.8D 1.9D (XUD9 & DW8 & DW8B) & 2.0HDI Boîte/ Gear box BE3R	310204	Manual Adjust	OPR 08337 (09/99) -> 03/02	200700	640/340	2150Y8-9634901780
		Auto Adjust	OPR 08337 (09/99) -> 03/02	200701	626/331	
CHAPE/BIELETTE POUR PEDALE DE DEBRAYAGE - CLUTCH CABLE LINKAGE						
306 all model			09/99 -> 03/02	310204		212822
309						
309 1.1 1.3 & 1.4 Boîte/ Gear box BE1 sauf/except mot XU		Manual	10/85 -> 07/88	200260	790/620	215068-215060- 9751811480
309 1.1 1.3 & 1.4 Boîte/Gear box BE1 sauf/except mot XU		Manual	07/88 -> 12/93	200330	790/620	215089
309 1.1 1.1i 1.4 & 1.4i Boîte/ Gear box MA		Manual	10/85 -> 07/89	200640	1285/1025	215093-9604052980
309 1.1 1.1i 1.4 & 1.4i Boîte/ Gear box MA sauf/except 1.4 (mot TU3S)		Manual	07/89 -> 12/93	200280	630/390	2150A8-9605079780
309 1.4 (mot TU3S) Boîte/Gear box MA		Manual	07/89 -> 12/93	200300	1275/1025	2150C0-9605128980
309 1.6 1.6i 1.9 1.9i GTI 1.8D & 1.9D Boîte/Gear box BE1		Manual	10/85 -> 07/88	200180	720/520	215071
309 1.6 1.6i 1.9 1.9i GTI 1.8D & 1.9D Boîte/Gear box BE1		Manual	07/88 -> 07/89	200250	730/510	215096-9603506880
309 1.6 1.6i 1.9 1.9i GTI GTI 16S 1.8D/ TD & 1.9D Boîte/Gear box BE3		Manual	07/89 -> 12/93	200320	660/390	2150A6-9605079580

Véhicule Vehicle	Réf. chape Cable linkage	Type	Année Year	SEIM P/n	Longueur Length	OE
PEUGEOT						
						<i>Suite...</i>
405						
405 1.4 (mot TU3) & 1.4i (mot TU3F2) Boîte/Gear box MA	310200	Manual	07/87 -> 10/96	200220	1320/1110	215087
405 1.6i 1.9 1.9i MI16 1.8D 1.8TD 1.9D (cde sur rotule/ball joint control) Boîte/ Gear box BE1	310200	Manual	07/87 -> Ch. 8102525	200200	730/540	215081
405 1.6i 1.9 1.9i MI16 1.8D 1.8TD 1.9D & all model 4X4 (cde sur axe/shaft control) Boîte/Gear box BE1 & BE3	310200	Manual	07/87 -> 06/92	200210	1360/1110	215079
405 1.9TD & MI16 Boîte/Gear box BE3	310200	Manual	07/92 -> 12/92	200420	1310/1130	2150E3
405 1.9TD & MI16 Boîte/Gear box BE3	310200	Manual Adjust	12/92 -> 10/96	200431	1323/1106	2150G3-9618266480
		Auto Adjust	12/92 -> 10/96	200430	1330/1180	
405 1.6 1.6i 1.8i 1.9 1.9i 1.9D Boîte/ Gear box BE3	310200	Manual Adjust	07/92 -> 10/96	200441	1460/1200	2150G2-9618266280
		Auto Adjust	07/92 -> 10/96	200440	1440/1240	
CHAPE/BIELETTE POUR PEDALE DE DEBRAYAGE - CLUTCH CABLE LINKAGE						
405 all model	avec épingle		07/87 -> 10/96	310200		212817
406						
406 1.6i 1.8i & 1.8i 16v Boîte/ Gear box BE3 & BE3R	Integrated in the cable	Manual Adjust	10/95 -> 04/99	200500	810/410	2150W3-9630903180
		Auto Adjust	10/95 -> 04/99	200780	820/400	2150N1-9619257280
406 1.9 TD & 2.0i 16v Boîte/ Gear box BE3 & BE3R	Integrated in the cable	Manual Adjust	10/95 -> 04/99	200490	860/530	2150W4-9630903380
		Auto Adjust	10/95 -> 04/99	200790	840/700	2150N2-9619257380
406 1.9 D Boîte/Gear box BE3 & BE3R	Integrated in the cable	Manual Adjust	10/95 -> 04/99	200720	850/400	2150W5-9630903980
		Auto Adjust	10/95 -> 04/99	200721	800/430	
406 restylé 1.6i-1.6 16v-1.8i-2.0i-2.0i 16v- 2.2 16v-3.0V6-2.0 HDI 90 & 110cv Boîte/ Gear box BE3R	Integrated in the cable	Manual Adjust	05/99 -> 04/04	200500	810/410	2150W3-9630903180
		Auto Adjust	05/99 -> 04/04	200780	820/400	2150N1-9619257280
505						
505 all model		Manual	07/79 -> 11/81	200130	740/450	215050
505 all model		Manual	11/81 -> 96	200140	810/450	2150C5
605						
605 all model sauf/except 2.1 TD Boîte/ Gear box ME5T	Integrated in the cable	Auto Adjust	09/89 -> 07/90	Not available		2150AK
605 2.1TD Boîte/Gear box ME5T	Integrated in the cable	Auto Adjust	09/89 -> 07/90	Not available		2150C8
605 all model Boîte/Gear box ME5T	Integrated in the cable	Auto Adjust	07/90->	Not available	730/480	2150K1-9623092980
605 all model Boîte/Gear box BE3	Integrated in the cable	Manual	09/89 -> 07/90	200451	826/516	2150A3-2150CC
605 all model Boîte/Gear box BE3	Integrated in the cable	Auto Adjust	07/90 -> 07/94	Not available	800/480	2150K2-9623092880
605 restylé 2.0i (114 cv) & 2.0i Turbo (141/147 cv) & 2.1 TD Boîte/Gear box ME	Integrated in the cable	Auto Adjust	07/94 -> 07/99	Not available	730/480	2150K1-9623092980
605 restylé 2.0 (114 cv) & 2.0i (121 cv) Boîte/Gear box BE3	Integrated in the cable	Auto Adjust	07/94 -> 07/99	Not available	800/480	2150K2-9623092880
605 restylé 2.0i-16V (132 cv) Boîte/ Gear box BE3 & BE3R	Integrated in the cable	Auto Adjust	07/94 -> 07/99	Not available	870/620	2150K0-9623303180
806						
806 1.8i & 2.0i 123cv (mot XU10J2) Boîte/ Gear box BE3 & BE3R	Integrated in the cable	Manual Adjust	07/94 -> 09/02	200511	770/330	2150S4-1476637080 1479128080
		Auto Adjust	07/94 -> 09/02	200510	770/330	
806 2.0i 132cv (mot XU10J4R) Boîte/ Gear box ML5T	Integrated in the cable	Manual Adjust	07/94 -> 09/02	200521	1060/725	2150P6-1476128080
		Auto Adjust	07/94 -> 09/02	200520	1090/720	
806 2.0 16V 136cv (mot EW10J4) Boîte/ Gear box BE4R	Integrated in the cable	Manual Adjust	07/94 -> 09/02	101780	980/640	2150AC-1487268080
		Auto Adjust	07/94 -> 09/02	101781	973/632	
806 2.0i Turbo Boîte/Gear box ME	Integrated in the cable	Manual Adjust	07/94 -> OPR 07391 (02/97)	101340	870/490	2150T1-1480346080 1476638080
		Auto Adjust	07/94 -> OPR 07391 (02/97)	101341	840/550	
806 2.0i Turbo Boîte/Gear box ML5T	Integrated in the cable	Manual Adjust	OPR 07392 (02/97) -> 09/02	200521	1060/725	2150P6-1476128080
		Auto Adjust	OPR 07392 (02/97) -> 09/02	200520	1090/720	

Véhicule Vehicle	Réf. chape Cable linkage	Type	Année Year	SEIM P/n	Longueur Length	OE
PEUGEOT						
						<i>Suite...</i>
806 1.9 Turbo D (XUD9TF & XUD9BTF) Boîte/Gear box ME	Integrated in the cable	Manual Adjust	07/94 -> OPR 07111 (03/96)	101340	870/490	2150T1-1480346080 1476638080
		Auto Adjust	07/94 -> OPR 07111 (03/96)	101341	840/550	
806 1.9 Turbo D (XUD9TF&XUD9BTF), 2.1 Turbo D (XUD11BTE) & 2.OHDI (mot DW10BTE) Boîte/Gear box ML5T	Integrated in the cable	Manual Adjust	03/96 -> 09/02	200521	1060/725	2150P6-1476128080
		Auto Adjust	03/96 -> 09/02	200520	1090/720	
BIPPER						
BIPPER 1.4i & 1.4HDI			10/07 ->	Not available		2150EA-55216695
BOXER						
BOXER 2.0i 1.9D 2.5D 2.5TD (emb poussé/ pushed clutch) Boîte/Gear box ME5T		Manual	02/94 -> 01/02	200560	1035/540	2150T5-2150J2 1310131080-1318447080
BOXER 1.9TD (emb poussé/pushed clutch) Boîte/Gear box ME5T		Manual	02/94 -> 01/02	200570	1058/520	2150T6-2150J4- 1312633080
BOXER 2.0i 2.5D 2.8D 2.8TD Boîte/ Gear box ML5T		Manual	02/94 ->	101730	1435/910	2150AV-2150Y5 1335052080-1322174080
BOXER 1.9 1.9 TD Boîte/Gear box ML5T		Manual	02/94 ->	101843	1478/910	2150AP-2150Z7 1335053080-1321581080 1321581080
BOXER 2.8D Boîte/Gear box MLGU		Manual	02/94 -> 01/02	554574	1080/645	2150CW-1336432080
BOXER 2.0i 2.5D 2.5TD 103 & 107cv Boîte/Gear box MG5T		Manual	02/94 -> 01/02	200580	1090/555	2150T7-2150J3 1310132080-1318446080
BOXER 2.8D 2.8TD & 2.8HDI (emb tiré/ Boîte/Gear box MG5T pulled clutch)		Manual	02/94 -> 03/05	200580	1090/555	2150T7-2150J3 1310132080-1318446080
BOXER 2.8D 2.8TD 2.8HDI (emb tiré/ pulled clutch) Boîte/Gear box MG5T		Manual	04/05 ->	554574	1080/645	2150CW-1336432080
EXPERT						
EXPERT 1.6i & 1.9 D (DW8B) Boîte/ Gear box BE3 & BE3R	Integrated in the cable	Manual Adjust	09/95 -> 12/03	200511	770/330	2150S4-1476637080 1479128080
		Auto Adjust	09/95 -> 12/03	200510	770/330	
EXPERT 1.9 D (DW8B) Boîte/ Gear box BE4R	Integrated in the cable	Manual Adjust	01/04 -> 12/06	101780	980/640	2150AC-1487268080
		Auto Adjust	01/04 -> 12/06	101781	973/632	
EXPERT 2.0 16V 136cv (EVW10J4) Boîte/ Gear box BE4R	Integrated in the cable	Manual Adjust	09/95 -> 12/06	101780	980/640	2150AC-1487268080
		Auto Adjust	09/95 -> 12/06	101781	973/632	
EXPERT 1.9 Turbo D (XUD9TF&XUD9BTF) Boîte/Gear box ME	Integrated in the cable	Manual Adjust	09/95 -> OPR 07111 (04/96)	101340	870/490	2150T1-1480346080 1476638080
		Auto Adjust	09/95 -> OPR 07111 (04/96)	101341	840/550	
EXPERT 1.9 Turbo D (XUD9TF & XUD9BTF) Boîte/Gear box ML5T	Integrated in the cable	Manual Adjust	OPR 07112 (04/96) -> 12/06	200521	1060/725	2150P6-1476128080
		Auto Adjust	OPR 07112 (04/96) -> 12/06	200520	1090/720	
EXPERT 2.0 HDI Boîte/Gear box ML5C	Integrated in the cable	Manual Adjust	09/95 -> 12/06	200522	1010/660	2150AN-1487725080
		Auto Adjust	09/95 -> 12/06	554565	1003/643	
J5						
J5 all model		Manual	10/81 -> 07/90	200150	1180/880	215055
J5 all model		Manual	07/90 -> 06/94	200480	1200/860	215000-2150E2-4460471 7724708-ZF04460471
PARTNER						
PARTNER (M49) 1.1-1.4-1.6-1.8 Boîte/ Gear box MA	Integrated in the cable	Manual Adjust	09/96 -> 10/02	101140	635/340	2150R1-9621451080
		Auto Adjust	09/96 -> 10/02	554562	635/340	
PARTNER (M49) 1.8D 1.9D (XUD9,DW8 & DW8B) & 2.0 HDI Boîte/Gear box BE3 & BE3R	Integrated in the cable	Manual Adjust	09/96 -> 10/02	101150	667/314	2150R2-9627513880
		Auto Adjust	09/96 -> 10/02	101151	665/330	
PARTNER (M49) 1.8i Boîte/Gear box BE3 & BE3R	Integrated in the cable	Manual Adjust	09/96 -> 10/02	101350	660//310	2150V1-9627514180
		Auto Adjust	09/96 -> 10/02	101351	660/310	
PARTNER (M49) 1.6 1.6 16V-1.9D Boîte/ Gear box BE4R	310204	Manual Adjust	De09/96 -> 10/02	101840	899/687	2150CX-9661239180 2150CF-9648780380 2150CS-9656675180 2150AH-9638424680
		Auto Adjust	09/96 -> 10/02	101791	899/687	
PARTNER (M59) 1.9D 1.6 16V 1.6 HDI 2.OHDI (90cv) Boîte/Gear box BE4R	310204	Manual Adjust	11/02 -> OPR 11189 (06/07)	101840	899/687	2150CX-9661239180 2150CF-9648780380 2150CS-9656675180 2150AH-9638424680
		Auto Adjust	11/02 -> OPR 11189 (06/07)	101791	899/687	

Véhicule Vehicle	Réf. chape Cable linkage	Type	Année Year	SEIM P/n	Longueur Length	OE
PEUGEOT						
<i>Suite...</i>						
PARTNER (M59) 1.9D-1.6 16V-1.6 HDi 2.0 HDi Boîte/Gear box BE4R	310204 sauf 2.0HDi	Manual Adjust	OPR 11190 (07/07) >	Not available		9806892280-2150CY
		Auto Adjust	OPR 11190 (07/07) >	554564	899/687	9664708080
CHAPE/BIELETTE POUR PEDALE DE DEBRAYAGE - CLUTCH CABLE LINKAGE						
PARTNER all model sauf/except 2.0 HDi (07/07->			09/96 >	310204		212822-9633830686
PARTNER 2.0 HDi			07/07 >	Not available		212831
RENAULT						
CLIO						
CLIO all model		Manual	06/90 > 08/98	401300	990/610	77004301127700809961
CLIO II all model		Manual	03/98 > 07/06	401690	954/667	8200741825-8200098019 7700421960-7700435284
KIT CREMAILLE DE DEBRAYAGE - CLUTCH PEDAL KIT						
CLIO				320208		7700679621
ESPACE						
ESPACE GTS TSE TXE 2000-1		Manual	07/84 > 04/91	401520	702/438	6025002833-6025002522 6025000718
ESPACE Turbo D Turbo DX 2000-1D		Manual	07/84 > 04/91	401090	715/445	6025002832
ESPACE II 2.1 dT 2.2i (avec masse/ with metal mass)		Manual	04/91 > 21/01/95	401430	1293/1100	6025103090 6025170728
ESPACE II 2.1 dT 2.2i (sans masse/ without mass)		Manual Adjust	01/95 > 06/97	401530	1300/1100	6025103091-6025111500
		Auto Adjust	01/95 > 06/97	554598	1290/1150	6025171255-6025171256
ESPACE III 1.9 dTi 2.0i 2.0i 16V (seulement une masse coté embrayage only with one metal mass)		Manual Adjust	12/96 > 09/02	Not available	1070/900	6025304915
		Auto Adjust	12/96 > 09/02	401540	1070/900	
ESPACE III 1.9 Dti (2 masses: 1 coté pédale & 1 coté BV/with 2 metal mass)		Manual Adjust	12/96 > 09/02	401650	1070/910	6025312553
		Auto Adjust	12/96 > 09/02	554600	1070/900	
ESPACE III Grand Espace 2.0i 2.0i 16V		Manual Adjust	01/98 > 09/02	Not available		6025304915
		Auto Adjust	01/98 > 09/02	401540	1070/910	
KANGOO						
KANGOO I 1.2-1.4-1.6-1.5 DCI 1.9D- 1.9dTi sauf/except KANGOO EXPRESS		Manual	09/97 > 06/03	401550	960/670	8200694035-7700417050 7700417052
KANGOO I 1.2-1.2 GPL-1.2 16v-1.4-1.6- 1.6 16v-1.5 DCI 55,60,65, 70 & 80- 1.9D sauf/except KANGOO EXPRESS		Manual	06/03 > 12/07	401690	954/667	8200741825 8200098019
KANGOO I EXPRESS 1.5 DCI 55,60,65, 70 & 80cv		Manual	09/97 > 12/07	401690	954/667	8200741825 8200098019
KANGOO I EXPRESS 1.2-1.2 16v & 1.6 16V		Manual	09/97 > 03/03	401690	954/667	8200741825- 8200098019
KANGOO I EXPRESS 1.2-1.2 GPL-1.2 16v -1.6 16v-1.6GNV-1.9D		Manual	03/03 > 12/07	401550	960/670	8200694035-7700417050 7700417052
LAGUNA						
LAGUNA & NEVADA 1.6 16V		Manual Adjust	01/94 > 09/98	401620	1180/910	7700431360
		Auto Adjust	01/94 > 09/98	401621		
LAGUNA & NEVADA 1.6 16V		Manual Adjust	09/98 > 11/00	Not available		7700432383
		Auto Adjust	09/98 > 11/00	401700	1125/866	
LAGUNA & NEVADA 1.8 1.8 16V & 2.0 (115cv)		Manual Adjust	01/94 > 09/98	Not available		7700413206-7700847976 7700840014-7700824073
		Auto Adjust	01/94 > 09/98	401610	1230/870	
LAGUNA & NEVADA 1.8 1.8 16V & 2.0 (115cv)		Manual Adjust	09/98 > 11/00	Not available		7700432383
		Auto Adjust	09/98 > 11/00	401700	1125/866	
LAGUNA & NEVADA 1.9 dTi		Manual Adjust	01/04/98 > 30/04/98	Not available		7700421415
		Auto Adjust	01/04/98 > 30/04/98	554764		
LAGUNA & NEVADA 1.9 dTi		Manual Adjust	01/05/98 > 11/09/98	401670	1190/910	8200018668- 7700428749
		Auto Adjust	01/05/98 > 11/09/98	401671	1220/...	
LAGUNA & NEVADA 1.9 dTi		Manual Adjust	11/09/98 > 11/00	Not available		7700432383
		Auto Adjust	11/09/98 > 11/00	401700	1125/866	
LAGUNA 2.0 16V type B56D (Mot Volvo N7Q 140cv)		Manual Adjust	01/94 > 11/00	Not available		7700413205-7700410706 7700410824
		Auto Adjust	01/94 > 11/00	401701	1230/870	

Véhicule Vehicle	Réf. chape Cable linkage	Type	Année Year	SEIM P/n	Longueur Lenght	OE
RENAULT Suite...						
LAGUNA 2.0 16V type B56M (Mot N7Q704 140cv)		Manual Adjust	01/94 > 30/04/98	Not available		7700413205-7700410706
		Auto Adjust	01/94 > 30/04/98	401701	1230/870	7700410824
LAGUNA 2.0 16V type B56M (Mot N7Q704 140cv)		Manual Adjust	01/05/98 > 09/98	401660	1170/900	7700428748
		Auto Adjust	01/05/98 > 09/98	401661		
LAGUNA 2.0 16V type B56M (Mot N7Q704 140cv)		Manual Adjust	01/10/98 > 11/00	Not available		7700432386
		Auto Adjust	01/10/98 > 11/00	401702	1098/895	
LAGUNA & NEVADA 2.2 D		Manual Adjust	01/94 > 11/00	Not available		7700413205-7700410706
		Auto Adjust	01/94 > 11/00	401701	1230/870	7700410824
LAGUNA 3.0 V6		Manual	01/94 > 11/00	401450	1080/750	7700840097-7700824074
MASTER						
MASTER Traction AV/front wheel drive 4 vitesses/speed		Manual	Orig >Ch. 22090	401060	1302/950	5000390299
MASTER Traction AV/front wheel drive 4 vitesses/speed		Manual	Ch. 22091 > 02/89	Not available	1400/1090	5000395151
MASTER Traction AV 5 Vitesses/front wheel drive 5 vitesses/ speed		Manual	> 02/89	401260	1397/1150	5000395159
MASTER Traction AV 5 Vitesses/front wheel drive 5 vitesses/ speed		Manual	02/89 > 11/98	401270	1327/1177	6006000873 7700745352
MASTER Propulsion AR/rear wheel drive		Manual	> 02/89	Not available	2050/1800	5000395755-5000390303
MASTER Propulsion AR/rear wheel drive		Manual	03/89 > 09/97	401600	2012/1805	7700745354
MEGANE & SCENIC						
MEGANE & SCENIC all model		Manual	11/95 > 09/02	401510	970/630	8200073170-7700423684 7700843206-7700429330 7700436837
MEGANE 2.016S		Manual	11/95 > 03/99	401500	972/630	7700843188
MEGANE 2.016S		Manual	03/99 > 09/02	401510	970/630	8200073170-7700423684 7700843206-7700429330 7700436837
KIT CREMAILLERE DE DEBRAYAGE - CLUTCH PEDAL KIT						
MEGANE / SCENIC				320207		7700832161
MEGANE				320208		7700679621
R4						
R4 type R1120			62 > 71	NEW 554856	800/670	7700553736
R4 type R1123 > n° de série ..1357385			> 74			
R4 type R1126 > n° de série ..196831	Manual		> 74			
R4 type R2106 > n° de série ..133610			66 > 73			
R4 type R2109 > n° de série ..93763			> 74			
R4 GTL F6 Cargo 112C		Manuel	> 06/82	400200	700/530	7700553737
R4 type R1123 n° de série ..1357386>			74>	400020	1048/950	7704001996
R4 type R1126 n° de série ..196832>			74>			
R4 type R2106 n° de série ..133611>	Manual		73>			
R4 type R2109 n° de série ..93764>			74>			
R4 type R2391 & R2392			74>			
R4 type R1128 210B R2370 239B R2430 112C S128		Manual	07/82 > 07/85	400920	661/502	7704001778
R5						
R5 L (levier de vitesse au volant/ shift lever on steering wheel)		Manual	01/74 > 07/81	400110	610/454	7700653308
R5 L (levier de vitesse au plancher/ shift lever to the floor)		Manual	01/74 > 07/81	400130	710/485	7700637793
R5 L (levier de vitesse au plancher/ shift lever to the floor)		Manual	07/81 >	400120	642/430	7704001872 7700659964
R9 & R11						
R9 & R11 all model sauf/except diesel - (sans masse/without metal mass)		Manual	07/81 > 06/89	400930	1050/650	7704001506
R9 & R11 diesel & all model (avec masse/with metal mass)		Manual	07/81 > 06/89	401130	1040/650	6006004557-7700783813 7700859233

Véhicule Vehicle	Réf. chape Cable linkage	Type	Année Year	SEIM P/n	Longueur Length	OE
RENAULT						
KIT CREMAILLERE DE DEBRAYAGE - CLUTCH PEDAL KIT						
R9 R11 all model				320208		7700679621
R12						
R12 all model		Manual	Ch.66444 > 12/80	400420	777/625	7701348399
R18						
R18 & FUEGO L TL GTL		Manual	03/79 > 12/87	400980	1070/840	7704002279-7701349128
R18 & FUEGO TL GTL GPL TS GTS AMERICAIN (1341 1351 1361)		Manual	04/78 >	400990	1520/1290	7704002282 7701349971
R18 & FUEGO TS GTS (1342 1352 1362 1365) & Turbo essence		Manual	04/78 >	401000	1465/1210	7704002290 7700696229
R18 & FUEGO GTX TX TD GTD		Manual	04/78 > 07/84	401010	1025/795	7704002286-7700688586
R18 & FUEGO GTX TX TD GTD Turbo D		Manual	07/84 > 12/87	401290	970/260	7700761516
R19						
R19 & CHAMADE all model		Manual	07/89 > 04/97	401140	1000/620	7700834725-7700787470 7700811013
KIT CREMAILLERE DE DEBRAYAGE - CLUTCH PEDAL KIT						
R19 all model				320208		7700679621
R21						
R21 & NEVADA TL (4 & 5 vitesses/speed)		Manual	01/86 > 04/89	401110	1129/878	7700781858-7700756971
R21 & NEVADA TL (4 & 5 vitesses/speed)		Manual	04/89 >	401180	1130/880	7700803913-7700797003
R21 & NEVADA TD GTD & RN RT 2.1D		Manual	01/86 > 12/95	401120	1380/1129	7700763191
R21 & NEVADA GTX TXE TXI RX TXI TI GTX & TXE		Manual	01/86 > 12/95	401160		7700763190
R21 & NEVADA SD & GSD 65cv		Manual	01/86 > 12/95	401390	1610/1360	7700803499
R21 & NEVADA TURBO D & DX		Manual	01/86 > 06/89	401100	1178/870	7700769247
R21 & NEVADA TURBO D & DX		Manual	06/89 > 12/95	401170	1215/905	7700799501
R21 & NEVADA TS TSE & GTS		Manual	01/86 > 06/89	401110	1129/878	7700781858-7700756971
R21 & NEVADA TS TSE GTS TSI GTS; RN 1.7 & RT 1.7		Manual	07/89 > 12/95	401180	1130/880	7700803913- 7700797003
KIT CREMAILLERE D'EMBRAYAGE						
R21 crémaillère simple/single rack				320205		7700765391
R21 crémaillère double/double rack				320206		7701464301
R25						
R25 TS GTS		Manual	03/84 > 06/88	400850	1298/1060	7700757740
R25 TS GTS		Manual	06/88 > 06/92	401190	1350/1150	7700795943-7700771181 7700804476
R25 TX GTX TI TXE TD GTD TURBO D/DX		Manual	03/84 > 06/92	401190	1350/1150	7700795943-7700771181 7700804476
R30						
R30 TURBO D		Manual	10/81 > 12/83	Not available	1498/900	7700001240
SAFRANE						
SAFRANE all model		Manual	04/92 > 08/00	401490	1229/952	7700827853-7700813657
SUPER CINQ & EXPRESS						
SUPER 5 & EXPRESS all model (sans masse/without metal mass)		Manual	10/84 > 08/00	400930	1050/650	7700761088
SUPER 5 & EXPRESS all model (avec masse/with metal mass)		Manual	10/84 > 08/00	401130	1040/650	6006004557-7700783813 7700859233
KIT CREMAILLERE DE DEBRAYAGE - CLUTCH PEDAL KIT						
SUPER 5 & EXPRESS			10/84 > 08/00	320208		7700679621
TRAFIC						
TRAFIC traction AV/front wheel drive/ & 4X4 1397 & 1721cm3		Manual	09/80 > 11/87	401030	700/460	7700690094 7700676427
TRAFIC traction AV/front wheel drive & 4X4 1397 & 1721cm3		Manual	11/87 > 09/01	401220	720/460	7700743104
TRAFIC traction AV/front wheel drive & 4X4 1995cm3 ess & 2068 diesel		Manual	09/80 > 09/01	401560	1400/1090	7700749179

Véhicule Vehicle	Réf. chape Cable linkage	Type	Année Year	SEIM P/n	Longueur Length	OE
RENAULT						
<i>Suite...</i>						
TRAFIC traction AV/front wheel drive & 4X4 2445 2499cm3		Manual	09/97 -> 09/01	401330	1270/1030	7700744556
TRAFIC propulsion AR/ rear wheel drive 1721cm3		Manual	09/80 -> 09/01	401030	700/460	7700690094
TRAFIC propulsion AR/ rear wheel drive 1397cm3		Manual	09/80 -> 09/01	401570	740/470	7700690096
TRAFIC propulsion AR/ rear wheel drive 1647cm3		Manual	09/80 -> 09/01	401580	1130/660	7700690097
TRAFIC propulsion AR/rear wheel drive 1995cm3 ess & 2068 diesel		Manual	03/89 -> 09/01	401340	1293/1090	7700738424
TRAFIC 1870 Diesel		Manual	11/97 -> 09/01	401630	1290/940	7700310186-7700310086
TRAFIC 2100 Diesel		Manual	11/97 -> 09/01	554684	1400/1060	7700747426-7701033510 7700736293
KIT CREMAILLE DE DEBRAYAGE - CLUTCH PEDAL KIT						
TRAFIC all model				320208		7700679621
TWINGO & TWINGO II						
TWINGO all model sauf/except EASY (automatic)		Manual	04/93 -> 06/07	401350	921/565	8200694111-7700430111 7700823050
TWINGO II 1.2 60cv & 1.2 16V 75cv		Manual	06/07 ->	554603		8200426378
KIT CREMAILLE DE DEBRAYAGE - CLUTCH PEDAL KIT						
TWINGO all model			04/93 -> 06/07	320208		7700679621

ROVER						
100						
100 1.1 1.1i 1.4 1.4i & 1.4D		Manual Adjust	05/90 -> 05/95	356204	835/872	GVC5056
100 1.1 1.1i 1.4 1.4i & 1.4D		Auto Adjust	05/90 -> 05/95	Not available		GVC5056
200						
213 all model			84 -> 12/89	Not available	1577/1137	GVC5005
214 1.4 1.4i à partir du ch. 33110087		Manual Adjust	10/89 -> 06/96	356200	735/480	UUC101250-GVC5044
		Auto Adjust	10/89 -> 06/96	Not available	735/480	UUC101250EVA
216 1.6i 8V				Not available	947/728	GVC5003
216 1.6i 8V modèle 1		Manual	10/89 -> 06/96	356201	1415/1280	GVC5030-5039
216 1.6 16V modèle 2		Manual	10/89 -> 06/96	356203	1440/1300	GVC5053
220		Manual	10/89 -> Ch. 231761	356203	1440/1300	GVC5053
218-220		Manual Adjust	Ch. 231762 -> 06/96	356202	875/610	GVC5050-UUC10049EVA
		Auto Adjust	Ch. 231762 -> 06/96	Not available	875/610	UUC10071
400						
414 1.4 1.4i		Manual Adjust	Ch. 33110087 -> 06/96	356200	735/480	GVC5044
		Auto Adjust	Ch. 33110087 -> 06/96	Not available		UUC101250EVA
416 1.6 8V		Manual	10/89 -> 06/96	356201	1415/1280	GVC5030-5039
416 1.6 16V		Manual	10/89 -> 06/96	356203	1440/1300	GVC5053
420 jusqu'au ch. 231761		Manual	10/89 -> Ch. 231761	356203	1440/1300	GVC5053
420 ch. 231762->		Manual Adjust	Ch. 231762-> 06/96	356202	875/610	GVC5050-UUC10049EVA
		Auto Adjust	Ch. 231762-> 06/96	Not available	875/610	UUC10071
MAESTRO						
MAESTRO all model			83 ->	Not available		ADU 6205
METRO						
METRO 1.4 1.4i & 1.4D		Manual Adjust	05/90 -> 05/95	356204	835/872	GVC 5056-UUC10067EVA
		Auto Adjust	05/90 -> 05/95	Not available		

SEAT						
AROSA						
AROSA all model		Manual Adjust	07/97 -> 11/00	721165	1110/820	6N1721335D-6N1721335J
		Auto Adjust	07/97 -> 11/00	721155	1060/813	6N1721335K-6X1721335

Véhicule Vehicle	Réf. chape Cable linkage	Type	Année Year	SEIM P/n	Longueur Lenght	OE
SEAT						
						<i>Suite...</i>
IBIZA & CORDOBA						
IBIZA all model		Manual	04/83 -> 87	Not available		
IBIZA all model sauf/except diesel & junior		Manual	87 -> 91	721010	620/365	SE022126201A39553500
IBIZA JUNIOR 903 cm3		Manual	87 -> 91	721160	590/300	SE021126201
IBIZA JUNIOR 903 cm3 Confort		Manual	91-> 05/93	721150	600/300	SE021126201A
IBIZA all model ess/gasoline (sauf/except junior)		Manual	01/89 -> 90	Not available	610/330	X03970398C
IBIZA all model DIESEL		Manual	04/83 -> 07/85	Not available	580/310	X059371150
IBIZA all model DIESEL		Manual	07/85 -> 01/89	721030	580/330	SE138126201A39553510
IBIZA all model DIESEL		Manual	01/89 -> 05/93	Not available	600/340	X039527580
IBIZA II /CORDOBA 1.6i mot ABU		Manual Adjust	Ch. 6KZR27093-> 09/99	554604	1097/823	6K1721335A
		Auto Adjust	05/93 -> 09/99	554605	1085/823	
IBIZA II /CORDOBA 1 6 1.8 TD 1.9TD montage T		Manual Adjust	05/96 -> 09/99	721163	1350/1016	6K1721335J
		Auto Adjust	05/96 -> 09/99	721153	1340/1028	
IBIZA II 1.05 (AAU), 1.3i (AAV), 1.3 (2G), 1.4 (ABD-AEX), 1.6 (ABU)		Manual	05-1993 ->Ch. 6KZR060 580 05-1993 ->Ch. 6KTR576 300	721151	1065/804	6K1721335H 6K1721335G
IBIZA II 1.6 (1F-AFT), 1.8 (ADZ-ABS), 1.8 16v (ADL), 2.0 GTI (2E), 1.9D (1Y), 1.9 TD (AAZ)		Manual Adjust	05-1993 ->Ch. 6KZR060 580 05-1993 ->Ch. 6KTR576 300	550490	865/598	6K1721335C 6K1721335B
		Auto Adjust	05-1993 ->Ch. 6KZR060 580 05-1993 ->Ch. 6KTR576 300	550553	857/642	
IBIZA II 1.6 (1F-AFT), 1.8 (ADZ-ABS), 1.8 16v (ADL), 2.0 GTI (2E), 1.9D (1Y), 1.9 TD (AAZ)		Manual	05-1993 ->Ch. 6KZR060 580 05-1993 ->Ch. 6KTR576 300	Not available		6K1721335K
IBIZA II 1.0 (AER-ALL), 1.4 (AKV-AEX-ABD), 1.6 (AEE-ALM), ,APQ; "A..":ANX		Manual	09-1999-> Ch. 6KX-000 001 -> Ch. 6KX-399 999	721151	1065/804	6K1721335H 6K1721335G
IBIZA II 1.6 (1F-AFT), 1.8 (ADZ), 1.9D (1Y & AEY), 1.9 Turbo D (AAZ), AGG,AEK		Manual Adjust	09-1999-> Ch. 6KX-000 001 -> Ch. 6KX-399 999	550490	865/598	6K1721335C 6K1721335B
		Auto Adjust	09-1999-> Ch. 6KX-000 001 -> Ch. 6KX-399 999	550553	857/642	
IBIZA II 1.6 (1F-AFT), 1.8 (ADZ), 1.9D (1Y & AEY), 1.9 TurboD (AAZ), AGG,AEK		Manual	09-1999-> Ch. 6KX-000 001 -> Ch. 6KX-399 999	Not available		6K1721335K
IBIZA II 2.0 GTI (ABF), 1.9 Turbo D (1Z), 1.9 Turbo D (AHU), 1K1		Manual Adjust	09-1999-> Ch. 6KX-000 001 -> Ch. 6KX-399 999	550562	1333/973	6K1721335L
		Auto Adjust	09-1999-> Ch. 6KX-000 001 -> Ch. 6KX-399 999	550561	1300/1012	
IBIZA II 2.0 GTI (ABF), 1.9 Turbo D (1Z), 1.9 Turbo D (AHU), 1K1		Manual	09-1999-> Ch. 6KX-000 001 -> Ch. 6KX-399 999	Not available		6K1721335M
IBIZA II 1.0 16v (AVZ), 1.4 16v (APE-AQQ-AUA-AUB), 1.6 (ALM), AST		Manual Adjust	09-1999-> Ch. 6KX-000 001 -> Ch. 6KX-399 999	721165	1110/820	6K1721335 6N1721335D 6N1721335J 6N1721335K
		Auto Adjust	09-1999-> Ch. 6KX-000 001 -> Ch. 6KX-399 999	721155	1060/813	
IBIZA II 1.0 (ALD-AUC-ANV), 1.4i (AUD-ANW-AKK)		Manual	6KX-400 000 >> 6KX-499 999	721154	985/740	6K1721335AA6K1721335Q 6K1721335T
IBIZA II 1.6 (ALM)		Manual	09-1999 -> 6K-1-039 973	721151	1065/804	6K1721335H6K1721335G
IBIZA II 1.0 16v (AVZ), 1.4 16v (APE-AQQ-AUA-AUB) 1.6 (ALM) AST		Manual Adjust	6K-1-039 974->	721165	1110/820	6K17213356N1721335D 6N1721335J6N1721335K
		Auto Adjust	6K-1-039 974->	721155	1060/813	
INCA						
INCA 1.4 8V		Manual	01/96 ->Ch. 9KY016847	721151	1065/804	6K1721335H6K1721335G

Véhicule Vehicle	Réf. chape Cable linkage	Type	Année Year	SEIM P/n	Longueur Length	OE
SEAT						
						<i>Suite...</i>
INCA 1.4 8V		Manual	Ch. 9KY016848 > 04	721154	987/715	6K1721335AA6K1721335Q 6K1721335T
INCA 1.4 16V		Manual Adjust	01/96 -> 04	721165	1110/820	6N1721335D6N1721335J
		Auto Adjust	01/96 -> 04	721155	1060/813	6N1721335K6K1721335
INCA 1.6 (1F)		Manual Adjust	01/96 -> 97	550490	865/598	6K1721335C
		Auto Adjust	01/96 -> 97	550553	857/642	6K1721335B
INCA 1.6 (AEE)		Manual	97 -> Ch. 9KY016847	721151	1065/804	6K1721335H6K1721335G
INCA 1.6 (AEE)		Manual	Ch. 9KY016848 > 04	721154	987/715	6K1721335AA6K1721335Q 6K1721335T
INCA 1.7 SDI 1.9D 1.9SDI		Manual Adjust	01/96 -> 04	550490	865/598	6K1721335C
		Auto Adjust	01/96 -> 04	550553	857/642	6K1721335B
MALAGA						
MALAGA all model essence/gasoline		Manual	85 > 12/92	721010	620/365	SE022126201A39553500
MALAGA all model Diesel		Manual	85 > 12/92	721030	580/330	SE138126201A39553510
MARBELLA						
MARBELLA 4 vitesses/speed		Manual	> 89	Not available		SE141126201A
MARBELLA 4 vitesses/speed		Manual	89 ->	721156	527/310	SE029110699C
MARBELLA 5 vitesses/speed		Manual	89 ->	721157	565/380	SE141126201B
RONDA						
RONDA 1.7D		Manual	07/85 -> 92	721030	580/330	SE138126201A
TERRA						
TERRA 4 vitesses/speed		Manual	> 89	Not available		SE141126201A
TERRA 4 vitesses/speed		Manual	89 ->	721156	527/310	SE029110699C
TERRA Break/SWV 5 vitesses/speed		Manual	01/91 -> 02/95	721157	565/380	SE141126201B
TERRA BV5 Fourgonette/van		Manual	02/87 -> 02/95	721157	565/380	SE141126201B
TERRA diesel		Manual	89 ->	721158	580/350	SE29110699AX03961680
TOLEDO						
TOLEDO 1.6 1.6i 1.8i 1.9D 1.9 TD 2.0i		Auto Adjust	07/91 -> 12/95	550430	800/550	191721335AB
SUZUKI						
ALTO						
ALTO all model		Manual	94 -> 01	554606	560/350	23710M72F30
ALTO all model		Manual	06/02 -> 12/06	Not available		23710M76G30
ALTO all model		Manual	09 ->	554584	665/420	23710M68K01
IGNIS						
IGNIS 1.3		Manual	09/03 ->	554608	660/390	2371086G00
IGNIS 1.3 DDIS		Manual	09/03 ->	554609	688/385	2371086G80
JIMNY						
JIMNY all model		Manual	00 ->	554610	1925/1767	2371081A61:2371081A40
SANTANA						
SANTANA Sj410		Manual	84 ->	731205	1670/1370	2371080420
SANTANA Sj413		Manual	85 ->	731201	1875/1550	2371083023
SANTANA Sj413		Manual	90 ->	731202	1855/1550	2371083024
SPLASH						
SPLASH all model		Manual	04/08 ->	554588	716/432	4709651-93195010
SWIFT						
SWIFT all model		Manual	89 ->	Not available		2371063B10/11
SANTANA						
SANTANA all model			85 ->	Not available		
VITARA						
VITARA 1.3		Manual	89 ->	731203	1840/1530	2371063A10:2371063A11 2371060B00
VITARA 1.6 sauf/except 16V		Manual	89 ->	Not available	1850/1598	2371060A10:2371060A11 2371060AA0

Véhicule Vehicle	Réf. chape Cable linkage	Type	Année Year	SEIM P/n	Longueur Length	OE
SUZUKI						
<i>Suite...</i>						
VITARA 1.6 16V		Manual	89 ->	731204	1850/1610	2371057B102371057B11 2371057B122371085C60
WAGON R						
WAGON R		Manual		554585	675/413	2371083E41-4707843 9216431
TALBOT						
SAMBA						
SAMBA all model		Manual	82 -> 86	200160	470/260	9150101780
TOYOTA						
AYGO						
AYGO 1.0i		Manual	06/05 ->	101844	1596/1396	2150CQ-313400H030
AYGO 1.4 D		Manual	06/05 ->	101845	1479/1277	2150CR-313400H040
VOLKSWAGEN						
CADDY						
CADDY II 1.4i 1.4i 16V		Manual Adjust	09/96 -> 03/04	721165	1110/820	6X17213356N1721335D
		Auto Adjust	09/96 -> 03/04	721155	1060/813	6N1721335J6N1721335K
CADDY II 1.6i (1F)		Manual Adjust	09/96 -> 97	550490	865/598	6K1721335C
		Auto Adjust	09/96 -> 97	550553	857/642	6K1721335B
CADDY II 1.6i (AEE)		Manual Adjust	97 -> 03	721165	1110/820	6X17213356N1721335D
		Auto Adjust	97 -> 03	721155	1060/813	6N1721335J6N1721335K
CADDY II 1.7 SDI 1.9D & 1.9 SDI		Manual Adjust	09/96 -> 03/04	550490	865/598	6K1721335C
		Auto Adjust	09/96 -> 03/04	550553	857/642	6K1721335B
CADDY II 1.9 TDI			09/96 -> Ch. 9KV508000	Not available		6K172335L
GOLF						
GOLF I 1.1 1.3 & 1.5		Manual	08/75 -> 83	550150	1055/793	171721335D
GOLF I 1.6 1.8 GTI 1.5D 1.6D & GTD		Manual	08/75 -> 83	550070	794/533	171721335E
GOLF I Cabriolet 90 & 112cv		Manual	07/81 -> 12/93	550070	794/533	171721335E
GOLF II 1.1 1.3 & 1.5		Manual	83 -> 86	550190	1048/789	191721335
GOLF II 1.1 1.3 & 1.5		Manual	86 -> 91	550420	1100/825	191721335R-191721335J
GOLF II 1.6 1.8 GLI & GTI		Manual	09/83 -> 08/84	550450	803/513	191721335A
GOLF II 1.6 1.8 GLI GTI & GTI 16V		Manual	09/84 -> 12/91	550320	806/492	191721335M-191721335C
GOLF II 1.6 1.8 GLI GTI & GTI 16V		Auto Adjust	86 -> 12/91	550430	800/550	191721335AB
GOLF II 1.6D & TurboD 70cv (mot JR)		Manual	09/84 -> 86	550210	837/537	191721335D
GOLF II 1.6D & TurboD 70cv (mot JR)		Manual	86 -> 07/89	550340	860/540	191721335N
GOLF II 1.6D & TurboD 70cv (mot JR)		Manual	07/89 -> 12/91	550320	806/492	191721335M
GOLF II 1.6D & TurboD 70cv (mot JR)		Auto Adjust	07/89 -> 12/91	550430	800/550	191721335AB
GOLF II 1.6 Turbo D 80cv (mot RA & SB)		Auto Adjust	07/89 -> 12/91	550541	1090/820	191721335F
GOLF III 1.4 1.6 (ABU & AEK)		Manual Adjust	01/92 -> 12/94	554612	1053/500 +200	1H1721335M- 1H1721335H
		Auto Adjust	01/92 -> 12/94	550542	1040/698	1H1721335M-1H1721335C 1H1721335H-1H1721335K
GOLF III 1.4 1.6 (AEA-AEE & AEK)		Manual Adjust	01/95 -> 12/97	550460	854/438 +65	1H1721335A-1H1721335B 1H1721335G
		Auto Adjust	01/95 -> 12/97	550440	827/508	1H1721335A-1H1721335B
GOLF III 1.8i 2.0 GTI (sauf/ except 16V) 1.9D TD & SDI		Manual Adjust	01/92 -> 12/97	550460	854/438 +65	1H1721335A-1H1721335B 1H1721335G
		Auto Adjust	01/92 -> 12/97	550440	827/508	1H1721335A-1H1721335B
JETTA						
JETTA I 1.1 1.3 & 1.5		Manual	08/75 -> 83	550150	1055/793	171721335D
JETTA I 1.6 1.8 GTI 1.5D 1.6D & GTD		Manual	08/75 -> 83	550070	794/533	171721335E
JETTA II 1.1 1.3 & 1.5		Manual	83 -> 86	550190	1048/789	191721335

Véhicule Vehicle	Réf. chape Cable linkage	Type	Année Year	SEIM P/n	Longueur Length	OE
VOLKSWAGEN						
						<i>Suite...</i>
JETTA II 1.1 1.3 & 1.5		Manual	86 -> 91	550420	1100/825	191721335R-191721335J
JETTA II 1.6 1.8 GLI & GTI		Manual	09/83 -> 08/84	550450	803/513	191721335A
JETTA II 1.6 1.8 GLI GTI & GTI 16V		Manual	09/84 -> 12/91	550320	806/492	191721335M-191721335C
JETTA II 1.6 1.8 GLI GTI & GTI 16V		Auto Adjust	86 -> 12/91	550430	800/550	191721335AB
JETTA II 1.6D & TurboD 70cv (mot JR)		Manual	09/84 -> 86	550210	837/537	191721335D
JETTA II 1.6D & TurboD 70cv (mot JR)		Manual	86 -> 07/89	550340	860/540	191721335N
JETTA II 1.6D & TurboD 70cv (mot JR)		Manual	07/89 -> 12/91	550320	806/492	191721335M
JETTA II 1.6D & TurboD 70cv (mot JR)		Auto Adjust	07/89 -> 12/91	550430	800/550	191721335AB
JETTA II 1.6 Turbo D 80cv (mot RA & SB)		Auto Adjust	07/89 -> 12/91	550541	1090/820	191721335F
LT						
LT 28 31 35 40 45 50 55 all model		Manual	Ch. 28D007274 -> 04/96	554613	1816/1588	281721335E-281721335F
LUPO						
LUPO all model		Manual Adjust	10/98 -> 06/05	721165	1110/820	6N1721335D-6N1721335J
		Auto Adjust	10/98 -> 06/05	721155	1050/870	6N1721335K-6X1721335
PASSAT						
PASSAT II all model diesel		Manual	08/81 ->	550520	950/650	321721335D-321721335E 321721335G
PASSAT III all model essence		Manual Adjust	10/89 -> 93	550552	1333/938	357721335E
		Auto Adjust	10/89 -> 93	550581		
POLO & DERBY						
POLO/ DERBY I (861/2) & II (86C) all model		Manual	75 -> Ch.F127903	550260	610/350	861721335A-867721335C
POLO/ DERBY II (86C) all model Ch.127904->		Manual	Ch. 127904-> 10/94	550470	610/310	867721335E
POLO III CLASSIC/FLIGHT 4 portes/ doors 1.4-1.6-1.9 SDI		Manual Adjust	03-1996->Ch.6NS015000	721165	1110/820	6X17213356N1721335D
		Auto Adjust		721155	1050/870	6N1721335J-6N1721335K
POLO III 1.3-1.4-1.6-1.9 SDI-1.9D-1.9 GTD		Manual Adjust	10/94->11/99	721165	1110/820	6X17213356N1721335D
		Auto Adjust		721155	1050/870	6N1721335J-6N1721335K
POLO III 1.4-1.6GTI-1.9 SDI-1.9D-1.9 GTD		Manual Adjust	11/99->12/01	721165	1110/820	6X17213356N1721335D
		Auto Adjust		721155	1050/870	6N1721335J-6N1721335K
TRANSPORTER						
TRANSPORTER IV all model		Manual Adjust	09/90 -> 02	550563	1287/687 +230	7011721335 -701721335B
		Auto Adjust	09/90 -> 02	550550	1252/943	-7D1721335
VENTO						
VENTO 1.4 1.6 (ABU & AEK)		Manual Adjust	01/92 -> 12/94	554612	1053/500 +200	1H1721335M -1H1721335H
		Auto Adjust	01/92 -> 12/94	550542	1040/698	1H1721335M-1H1721335C 1H1721335H-1HC1721335K
VENTO 1.4 1.6 (AEA AEE & AEK)		Manual Adjust	01/95 -> 12/97	550460	854/438 +65	1H1721335A- 1H1721335B-1H1721335G
		Auto Adjust	01/95 -> 12/97	550440	827/508	1H1721335A-1H1721335B
VENTO 1.8i 2.0 GTI (sauf/except 16V) 1.9D TD & SDI		Manual Adjust	01/92 -> 12/97	550460	854/438 +65	1H1721335A-1H1721335B- 1H1721335G
		Auto Adjust	01/92 -> 12/97	550440	827/508	1H1721335A-1H1721335B

Accessoires pour pédale de débrayage - Accessories for clutch pedal**Bielles / Chapes / Cable linkage**

Attention sur certains câbles il est nécessaire d'ajouter une biellette pour raccorder le câble à la pédale de débrayage.

Caution for some of the cables it is necessary to add a link to connect the cable to the clutch pedal.

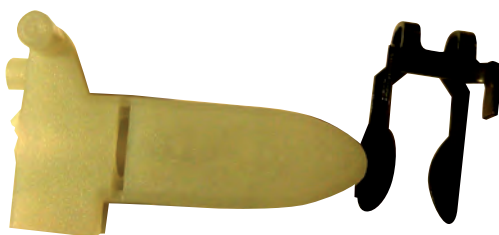
**310200****310202****310203****310204****310205**

Accessoires pour pédale de débrayage - Accessories for clutch pedal

Suite...

Crémaillère de débrayage / Clutch pedal kit

La crémaillère permet de régler la hauteur de garde des pédales de débrayage.

The kit allows you to adjust the height of custody clutch pedals.



320200



320201



320202



320203



320204



320205



320206



320207



320208



Lined area for notes with horizontal dotted lines.

Câbles de frein



Brake cables

Funi freno a mano

Mando freno de mano

Bremsseile

Sommaire

Contents

ALFA ROMEO	75
AUDI	76
BMW	78
CHEVROLET/DAEWOO	79
CHRYSLER	80
CITROËN	81
DACIA	87
FIAT	88
FORD	95
HONDA	104
HYUNDAI	105
IVECO	106
ISUZU	107
JEEP	107
KIA	108
LADA	109
LANCIA	109
LAND ROVER	111
MAZDA	111
MERCEDES	113
MG	122
MINI (BMW)	122
MITSUBISHI	123
NISSAN	124
OPEL	127
PEUGEOT	132
PORSCHE	139
RENAULT	139
ROVER	148
SAAB	149
SEAT	149
SKODA	152
SMART	153
SUBARU	153
SUZUKI	153
TALBOT	154
TOYOTA	155
VOLKSWAGEN	158
VOLVO	163

Comment utiliser l'onglet câble de frein ?

How to use brake cable tab ?

Véhicule Vehicle	Position	Année Year	SEIM P/n	Kit P/n	Longueur Length	OE
CITROËN Suite...						
C3 II (A51) (suite)						
New C3 (A51) 1.4 VTI (freins à tambours/drum brake)	G/L or D/R	09/09 >	554759		1706/879	474659-9671814180
New C3 (A51) 1.6 VTI 1.6 HDI 90-92 & 110cv (freins à disques/disc brake)	G/L or D/R	09/09 >	554760		1803/1024	474660-9671815180
C3 PICASSO						
C3 PICASSO all model	G/L or D/R	11/04 > 07/08	204260			74620-9661966980 74620-9661966980
C4 all model	G/L or D/R	11/04 > 07/08	204260			74620-9661966980 74620-9661966980
C4 II (B7) all model sauf/except 2.0 HDI 140 cv	G/L or D/R					
C4 II (B7) 2.0 HDI 140 cv	G/L or D/R					
C4 II (B7) all model avec frein électrique/ with electric brake	Primaire Front					
C4 II (B7) 1.6VTi16v120cv-1.6THP155- 1.6HDI 110 & 115cv-2.0 HDI 150cv avec frein électrique/with electric brake	G/L or D/R					
C4 PICASSO						
C4 PICASSO all model	Primaire Front					
C4 PICASSO & Grand PICASSO all model	G/L D/R					
C4 PICASSO all model avec frein électrique/ with electric brake	G/L D/R					
C5 & C5 II						
C5 all model	G/L or D/R					
C5 II (X7) all model avec frein manuel/ with manual brake	G/L or D/R					
C5 II (X7) all model avec frein électrique/ with electric brake	G/L or D/R					
C8						
C8 all model avec silencieux AR longitudinal/ with longitudinal rear silencer	Primaire Front					
C8 all model avec silencieux AR longitudinal/ with longitudinal rear silencer	G/L					
C8 all model avec silencieux AR longitudinal/ with longitudinal rear silencer	D/R					
C8 all model avec silencieux AR longitudinal/ with longitudinal rear silencer	Primaire Front					
C8 all model avec silencieux AR longitudinal/ with longitudinal rear silencer	Primaire Front					
C8 all model avec silencieux AR longitudinal/ with longitudinal rear silencer	G/L	OPR 10285 (02/05)> 12/06	554050		1041/840	474619-4745Y8-1400310380
C8 all model avec silencieux AR longitudinal/ with longitudinal rear silencer	D/R	OPR 10285 (02/05)> 12/06	554051	805021	2308/2151	4745Y6-4745Y7 1400310280-1400310180
C8 all model avec silencieux AR longitudinal/ with longitudinal rear silencer	G/L or D/R	01/06 >	554108	805037	1257/1115	474609-1400204180

 Modèle
 Model

 Date de fabrication
 Date of manufacture

 Référence Seim
 Seim P/n

 Longueur en mm :
 Câble/Gaine
 Length in mm
 Cable/girdle

 Référence d'origine
 OE P/n

Primaire/Front : Câble de frein primaire (relié au frein à main)
Primaire/Front : Primary brake cable (connected to the handbrake)

Intermediate : Câble intermédiaire qui est assemblé entre le câble de frein primaire et les câbles de frein arrière ou les câbles de liaison.

Intermediate : Intermediate cable which is connected between primary brake cables and the rear brake cables or small link cable.

Liaison G/L or D/R : Petit câble qui peut être assemblé aussi bien côté gauche que côté droit au niveau des tambours ou disques de frein. Ce câble est assemblé après le câble intermédiaire.

Liaison G/L or D/R : Small cable that can be assembled as well as left right at the drum or brake disc. This cable is assembled after the intermediate cable.

G/L : Câble de frein côté gauche (côté conducteur)
G/L : Left side brake cable (driver side if left hand drive).

D/R : Câble de frein côté droit (côté passager).
D/R : Left side brake cable (passenger side if left hand drive)

G/L or D/R : Câble de frein qui peut être assemblé aussi bien côté gauche que côté droit.

G/L or D/R : Brake cable which can be connected as well as left right side

Unique/Single : Ensemble de deux câbles coté gauche et coté droit reliés ou non par un palonnier.

Unique/Single : Set of two cables left and right side connected or not by a brake compensator.

Kit G/L et D/R : Ensemble de deux câbles coté gauche et coté droit. Il se peut que les deux câbles soient identiques si la mention « **G/L or D/R** » est présente dans la colonne position.

Kit G/L et D/R : Set of two cables left and right side. It may be that both cables are the same if «G/L or D/R» is present in the position column.

**Pour toutes questions notre service technique est disponible
 du lundi au vendredi de 8H00 à 12H15 et de 13H15 à 17H00
 Tél. 04 74 46 07 36**

Véhicule Vehicle	Position	Année Year	SEIM P/n	Kit P/n	Longueur Length	OE
ALFA ROMEO						
ALFA 145						
ALFA 145 1.3	Primaire Front	08/94>04/99	702240		406	7609367-46410282-92323732 60806293-60811362
ALFA 145 1.3	G/L	08/94>04/99	703410		1460/1060	46463910-60813764-7773015
	D/R	08/94>04/99	NEW 554857		1419/1015	7773019
ALFA 145 1.6	Primaire Front	08/94>02/97	702240		406	7609367-46410282-92323732 60806293-60811362
ALFA 145 1.6	G/L	08/94>02/97	703410		1460/1060	46463910-60813764-7773015
	D/R	08/94>02/97	NEW 554857		1419/1015	7773019
ALFA 145 1.6	Primaire Front	03/97>04/99	702240		406	46410282-7609367-92323732 60806293-60811362
ALFA 145 1.6	G/L	03/97>04/99	703350		1430/1050	46468156-7791233-46465947
	D/R	03/97>04/99	703360	803360	1380/990	46737015-7791231-46468155 46465194
ALFA 145 2.0 Quadrifoglio	Primaire Front	08/94>04/99	702240		406	46410282-7609367-92323732 60806293-60811362
ALFA 145 2.0 Quadrifoglio	G/L	08/94>04/99	703490		1510/1180	46456849-7714822-60812546 46401730
	D/R	08/94>04/99	703491	803490	1460/1120	46456850-76153342-60812799 60577826-60806310
ALFA 145 1.7 16v	Primaire Front	08/94>04/99	702240		406	7609367-46410282-92323732 60806293-60811362
ALFA 145 1.7 16v (freins à disques/disc brake)	G/L	08/94>04/99	703490		1510/1180	46456849-7714822-60812546 46401730
	D/R	08/94>04/99	703491	803490	1460/1120	46456850-76153342-60812799 60577826-60806310
ALFA 145 1.4-1.9 TD	Primaire Front	08/94>04/99	702240		406	46410282-7609367-92323732 60806293-60811362
ALFA 145 1.4-1.9 TD sans/without ABS	G/L	08/94>04/99	703350		1430/1050	46468156-7791233-46465947
	D/R	08/94>04/99	703360	803360	1380/990	46737015-7791231-46468155 46465194
ALFA 145 1.4-1.9 TD avec/with ABS	G/L	08/94>04/99	703490		1510/1180	46456849-7714822-60812546 46401730
	D/R	08/94>04/99	703491	803490	1460/1120	46456850-76153342-60812799 60577826-60806310
ALFA 146						
ALFA 146 1.4-1.6-1.8-2.0-1.9 TD	Primaire Front	04-99>10-01	702240		406	46410282-7609367-92323732 60806293-60811362
ALFA 146 1.4-1.6-1.8-2.0-1.9 TD sans/without ABS	G/L	04-99>10-01	703350		1430/1050	46468156-7791233-46465947
	D/R	04-99>10-01	703360	803360	1380/990	46737015-7791231-46468155 46465194
ALFA 146 1.4-1.6-1.8-2.0-1.9 TD avec/with ABS	G/L	04-99>10-01	703490		1510/1180	46456849-7714822-60812546 46401730
	D/R	04-99>10-01	703491	803490	1460/1120	46456850-76153342-60812799 60577826-60806310
ALFA 147						
ALFA 147 all model	Primaire Front	09/00>10/10	702240		406	7609367-46410282-92323732
ALFA 147 all model (freins à disques/disc brake)	G/L	09/00>10/10	554000		1235/961	46847297-46542828
	D/R	09/00>10/10	554001	805000	1170/895	46542755
ALFA 156						
ALFA 156 all model	Primaire Front	10/97 >04/07	702240		406	46410282-60806293-60811362
ALFA 156 & 156 SW all model sauf/except 4x4	G/L	10/97 >04/07	703500		1256/985	60624591
	D/R	10/97 >04/07	703501		1196/920	60624590

Véhicule Vehicle	Position	Année Year	SEIM P/n	Kit P/n	Longueur Lenght	OE
ALFA ROMEO						
ALFA 159						
ALFA 159 & 159 SW all model	G/L	09/05->05/13	554002	805001	1755/1603	50505371-50500558
	D/R	09/05->05/13	554003		1735/1585	50505370-50500557
ALFA 164						
ALFA 164 all model	Primaire Front	07/88->08/98	554004		275	60807617-82399827
ALFA 164 all model	Unique Single	07/88->08/98	703110		2950/1235x 1375	82441688-82390671-6081383
ALFA 166						
ALFA 166 all model	Primaire Front	10/98 ->07/07	554753		311	60813842-82488247
ALFA 166 all model	G/L	10/98 ->07/07	554754		1445/1320	60661488-60630812
	D/R	10/98 ->07/07	554755		1427/1303	60661490-60630814
ALFA BRERA						
ALFA BRERA all model	G/L	04/06 ->	554005		1662/1529	50505483
	D/R	04/06 ->	554006		1577/1445	50505484
ALFA GT COUPE						
ALFA GT COUPE 2.0 JTS et 1.9JTD (freins à disques/disc brake)	Primaire Front	98 ->	702240		406	46410282-60806293-60811362
ALFA GT COUPE 2.0 JTS et 1.9JTD (freins à disques/disc brake)	G/L	03/04->12/10	703500		1256/985	60624591
	D/R	03/04->12/10	703501		1196/920	60624590
ALFA GIULIETTA						
ALFA GIULIETTA II all model	G/L	03/10 ->	NEW 554858		1793/1617	50502989
	D/R	03/10 ->	NEW 554859		1860/1681	50502987
ALFA MITO						
ALFA MITO all model	G/L	08/08 ->	NEW 554860		1641/1422	51844531-50519022-51871599- 55704104-55700929
	D/R	08/08 ->	NEW 554861		1658/1440	51871598-51871599-50519020- 55704103-55700927

AUDI						
A1						
A1 all model sauf/exept/Quattro	G/L or D/R	06/10 ->	554421	805083	1642/1044	6C0609721-6R0609721C
A1 all model Quattro	G/L or D/R		Not available			8X0609721A
A2						
AUDI A2 1.4 & 1.4 TDI (freins à tambours/drum brake)	G/L or D/R	00 -> 03	554008		1075/814	8Z0609721F-8Z0609722G 8Z0609722C-8Z0609721B
AUDI A2 all model (freins à tambours/drum brake)	G/L	03 ->Ch. 8Z3010000	554008		1075/814	8Z0609721F-8Z0609722G 8Z0609722C-8Z0609721B
	G/L	Ch.8Z3010001 ->	554007		1057/795	8Z0609721G-8Z0609721C
	D/R	03 ->	554008		1075/808	8Z0609721F-8Z0609722G 8Z0609722C-8Z0609721B
AUDI A2 all model sauf/exept/ 1.4 TDI (freins à disques/disc brake)	G/L	03 ->Ch n°8Z4100000	554009		1152/941	8Z0609721A-8Z0609722D
	G/L	Ch n°8Z4100001 ->	554010		1130/923	8Z0609721D
AUDI A2 1.4 TDI (freins à disques/disc brake)	G/L	03 ->	554011		1125/912	8Z0609721E
AUDI A2 all model y compris/include 1.4 TDI	D/R	03 ->	554009		1152/941	8Z0609721A-8Z0609722D
A3						
AUDI A3 (8L1) all model sauf/exept Quattro all model avec embout hexagonal/with hexagonal end-fitting (freins à disques/disc brake)	G/L or D/R	09/96 -> Ch n°8LX200000	553081		1693/1055	1J0609721E-1J0609721H
AUDI A3 (8L1) all model avec embout en forme de boule/with ball shaped end-fitting sauf/exept Quattro (freins à disques/disc brake)	G/L or D/R	Ch n° 8LY000001 -> 06/03	723362		1688/1064	1J0609721AQ-1J0609721AC 1J0609721AD-1J0609721AG 1J0609721AF-1J0609721AP 1J0609721T

Véhicule Vehicle	Position	Année Year	SEIM P/n	Kit P/n	Longueur Lenght	OE
AUDI						
A3 (suite)						
AUDI A3 (8L1) 1.8T Quattro-S3 Quattro & 1.9TDI Quattro	G/L or D/R	09/96 -> 06/03	553083		1723/1090	1J0609721AR-1J0609721L 1J0609721R
AUDI A3 II (8P1) & A3 II Sportback (8PA) all model sauf/except Quattro	G/L or D/R	06/03 -> 06/08 06/08 -> 07/12	553084		1447/807	1K0609721BE-1K0609721Q 1K0609721S
AUDI A3 II (8P1) & A3 II Sportback (8PA) 1.8 & 2.0 TFSI Quattro-3.2 V6 Quattro-2.0TDI Quattro 140 & 170cv	G/L or D/R	06/03 -> 06/08 06/08 -> 07/12	554417		1447/805	1K0609721BB-1K0609721AA 1K0609721AF-1K0609721T
AUDI A3 II (8P7) cabriolet/convertible all model	G/L or D/R	02/08 ->	554756		1428/790	1K0609721BF-1K0609721BG
A4						
AUDI A4 (8D2-B5) & A4 AVANT (8D5-B5) all model sauf/except S4	G/L or D/R	02/95 -> 09/01	553085	853085	1815/1640	8D0609721AA-8D0609721H
AUDI A4 (8D2-B5) & A4 AVANT (8D5-B5) S4	G/L or D/R	02/95 -> 01	554013		1770/1600	8E0609721AC-8E0609721BA
AUDI A4 II all model sauf/except Quattro	G/L	01/01 -> 04/08	554014	805002	1928/1765	8E0609721AQ-8E0609721L 8E0609721AF-8E0609721AG 8E0609721N-8E0609721H 8E0609721D-8E0609721AH 8E0609721AS
	D/R	01/01 -> 04/08	554015		2005/1843	8E0609722AN-8E0609722L 8E0609722AF-8E0609722AG 8E0609722N-8E0609722H 8E0609722D-8E0609722AQ 8E0609722AS
AUDI A4 II all model Quattro	G/L or D/R	01/01 -> Ch.8E-3-500000.	554014		1928/1765	8E0609721AQ-8E0609721L 8E0609721AF-8E0609721AG 8E0609721N-8E0609721H 8E0609721D-8E0609721AH 8E0609721AS
AUDI A4 II all model Quattro	G/L or D/R	Ch. 8E-4-000001-> 04/08	554017		1736/1572	8E0609721AR-8E0609721AJ 8E0609721AF-8E0609721AL
AUDI A4 II cabriolet/convertible (8H7-B6-8HE-B7) all model sauf/except Quattro	G/L or D/R	01/01 -> 04/08	554014	805002	1928/1765	8E0609721AQ-8E0609721L 8E0609721AF-8E0609721AG 8E0609721N-8E0609721H 8E0609721D-8E0609721AH 8E0609721AS
AUDI A4 II cabriolet/convertible all model Quattro	G/L or D/R	01/01 -> 04/08	554017		1736/1572	8E0609721AR-8E0609721AJ 8E0609721AF-8E0609721AL
A6						
AUDI A6 & A6 AVANT (4AC4) all model	G/L or D/R	07/94 -> 06/97	554018	805004	1491/922+367	4A0609721D
AUDI A6 & A6 AVANT (4AC4) all model Quattro & S6	G/L	07/94 -> 06/97	554019		1697/1520	441609721D
	D/R	07/94 -> 06/97	554020		1676/1503	441609722D
AUDI A6 II & A6 II AVANT (4B-C5) sauf/except Quattro-Allroad & S6	G/L	06/97 -> 04/05	554021	805005	1958/1705	4B0609721AC-4B0609721M- 4B0609721R
	D/R	06/97 -> 04/05	554022		1958/1705	4B0609722Q-4B0609722L 4B0609722N
AUDI A6 II & A6 II AVANT (4B-C5) all model Quattro-Allroad & S6	G/L or D/R	06/97 -> 12/05	554023		1925/1762	4B0609721AD-4B0609721S 4B0609721N
A8						
AUDI A8 all model			Not available			
Q5						
Q5 all model		10/08 ->	Not available			
Q7						
Q7 all model	Primaire Front	03/06 -> 04/09 ->	554649		1890/1685	7L0721556B-7L0609556B
Q7 all model	G/L or D/R	03/06 -> Ch n°4L-9-050 000 Ch n°4L-9-901 000	554650		1910/1790	7L8609721B

Véhicule Vehicle	Position	Année Year	SEIM P/n	Kit P/n	Longueur Lenght	OE
AUDI						
Q7 (suite)						
Q7 all model	G/L or D/R	Ch n°4L-9050 001-> Ch n°4L-901 001->	554650		1910/1790	718609721C
TT						
AUDI TT (coupé) all model sauf/except quattro	G/L or D/R	98 -> Ch n°8NY011100	554024		1613/1056	8N0609721C
AUDI TT Coupé & Roadster all model sauf/except quattro	G/L or D/R	Ch n°8NY011101 -> 09/06	554025		1613/1056	8N0609721F
AUDI TT Coupé & Roadster Quattro all model	G/L or D/R	10/98 -> 09/06	554026		1660/1105	8N0609721H-8N0609721G 8N0609721E
AUDI TT II Coupé & Roadster all model	G/L	09/06 -> 04/10 ->	NEW 554862		1417/782	8J0609721E
	D/R	09/06 -> 04/10 ->	NEW 554863		1385/770	8J0609722E
80 & 90						
AUDI 80 & 90 all model (freins à tambours/drum brake)	G/L	85 -> 87	550270		1180/420	811609721H
	D/R	85 -> 87	550280		1136/420	811609722D
AUDI 80 & 90 all model (freins à disques/disc brake)	G/L	85 -> 08/91	553070		1260/520	811609721G
	D/R	85 -> 08/91	553080		1208/520	811609722C
AUDI 80 & 90 all model (freins à tambours/drum brake)	G/L	87 -> 08/91	553097		1364/1080	893609721G
	D/R	87 -> 08/91	553098		1300/1040	893609722G
AUDI 80 & 90 all model (freins à tambours/drum brake)	G/L or D/R	09/91 ->	553095	853095	1580/1350	8A0609721AE
AUDI 80 & 90 all model (freins à disques/disc brake)	G/L or D/R	09/91 ->	553096	853096	1720/1560	8A0609721AF
100						
AUDI 100 all model sauf/except Quattro (freins à disques/disc brake)	G/L or D/R	85 -> 92	553090		1472/890	443609721G
AUDI 100 all model sauf/except Quattro (freins à disques/disc brake)	G/L or D/R	92 ->	553093		1480/910	4A0609721F
AUDI 100 Quattro (freins à disques/disc brake)	G/L	94 ->	554019		1697/1520	441609721D
	D/R	94 ->	554020		1676/1503	441609722D
AUDI 100 all model (freins à tambours/drum brake)	G/L or D/R	92 ->	553092			4A0609721E
200						
Audi 200 all model sauf/except Quattro			Not available			
AUDI 200 Quattro (freins à disques/disc brake)	G/L	94 ->	554019		1697/1520	441609721D
	D/R	94 ->	554020		1676/1503	441609722D

BMW						
SERIE 1						
SERIE 1 E81-E82 coupé-E87-E88 cabriolet/ convertible all model	G/L or D/R	09/04 ->	554027	805006	1434/755	34406760443
SERIE 1 F20-F21-F22 coupé all model	G/L or D/R	08/11 ->	NEW 554865		1463/782	34406792263-34406857639 34406851830
SERIE 3 & SERIE 3 TOURING						
SERIE 3 E36 Compact 316g-316i-318tds (freins à tambours/drum brake)	G/L or D/R	03/94 -> 12/00	554030	805009	1740/1070	34411160873
SERIE 3 E36 Compact 316g-316i-318tds- 318ti-323ti (freins à disques/disc brake)	G/L or D/R	03/94 -> 12/00	NEW 554864		1680/1090	34401166053
SERIE 3 E36 coupé, cabriolet/convertible, berline/ sedan & Touring 316i-318i-318is-320i-323i- 325i-328i-M3-318tds-325td-325tds (freins à disques/disc brake)	G/L or D/R	01/91 -> 06/99	554028	805007	1631/1062	34411160134
SERIE 3 E36 coupé & berline/sedan 316i 318i & 318tds (freins à tambours/drum brake)	G/L or D/R	01/91 -> 06/99	554029	805008	1764/1084	34411159048
SERIE 3 E46 coupé, cabriolet/convertible, berline/sedan & Touring all model	G/L	05/98 -> 02/05	353002	805123	1693/1140	34411165021
	D/R	05/98 -> 02/05	353001		1703/1140	34411165020

Véhicule Vehicle	Position	Année Year	SEIM P/n	Kit P/n	Longueur Lenght	OE
BMW Suite...						
SERIE 3 & SERIE 3 TOURING (suite)						
SERIE 3 E90-E92 coupé-E93 cabriolet/convertible & E91 Touring all model	G/L or D/R	03/05 ->	554032	805011	1533/755	34406769368-34406760444
SERIE 3 F30-F31 Touring-F32 coupé & F33 coupé all model	G/L or D/R	11/11 ->	NEW 554866		1584/799	34406857640-34406792269
SERIE 5						
SERIE 5 E39 & Touring all model	G/L	01/96 -> 06/03	353003	805124	1930/1170	34401166234-34411162998
	D/R	01/96 -> 06/03	353004		1890/1120	34401166237-34411162999
SERIE 5 E60 & E61 Touring all model	G/L	07/03 ->	554033	805012	1681/1170	34406761097-34406770603
	D/R	07/03 ->	554034		1673/1170	34406761098-34406770602
SERIE 6						
SERIE 6 E64 all model	G/L		Not available			34406770605
	D/R		Not available			34406770604
SERIE 7						
SERIE 7 E38 & E65 all model			Not available			
X1						
X1 E84 all model	G/L or D/R	07/09 -> 06/12 ->	NEW 554867		1558/779	34406857642-34406769367
X3						
X3 E83 all model	G/L	09/03 ->	554035	805013	1613/1230	34403400795
	D/R	09/03 ->	554036		1634/1230	34403400796
X5						
X5 E53 all model sauf/except 4.4 i & 4.6i	G/L or D/R	07/99 -> 12/06	554037	805014	1942/1161	34411165699
X5 E53 4.4 i & 4.6 i	G/L or D/R	07/99 -> 12/06	554038		1930/1161	34416751843
X5 E70 All model	G/L	02/07->	Not available			34436772103
	D/R	02/07->	Not available			34436772104
X6						
X6 E71-E72 All model	G/L	06/08->	Not available			34436772103
	D/R	06/08->	Not available			34436772104
Z3						
Z3 1.8i & 1.9i	G/L or D/R	97 -> 09/02	554039		1255/910	34401166054-34411163084
Z3 1.9i-2.0-2.2i-2.8i-3.0iM	G/L or D/R	97 -> 09/02	554040		1283/942	34411163276-34401166055
Z4						
Z4 E85 & E86 all model	G/L or D/R	10/02 ->	554041		1090/883	34416785397-34416757547 34406780959

CHEVROLET/DAEWOO						
AVEO						
AVEO all model	G/L	03/06 ->	554076		1396/1200	96534871
	D/R	03/06 ->	554077		1383/1188	96534870
CAPTIVA						
CAPTIVA all model	G/L	05/06 ->	554078			4804783-96625953-96879436
	D/R	05/06 ->	554079			4804784-96625954-96879437
CRUZE						
CRUZE 1.6i 16v & 2.0 VCDi 4 portes/doors (freins à disques/disc brake)	Unique Single	03/09 -> 2011	NEW 554868		1806/1678	522063-13328132
CRUZE 1.6i 16v 4 portes/doors (freins à tambours/drum brake)	G/L or D/R	11->	NEW 554874		1460/1340	13328133-13309422
CRUZE 2.0 VCDi 4 portes/doors (freins à tambours/drum brake)	G/L or D/R	11->	NEW 554875		1473/1352	13352978
CRUZE 1.6i 16v & 2.0 VCDi 4 portes/doors (freins à tambours/drum brake)	Liaison G/L or D/R	11->	NEW 554876		206	13304906
CRUZE all model 5 portes/doors (freins à disques/disc brake)	G/L	11->	NEW 554877		1810/1685	13368691-13350099
CRUZE all model 5 portes/doors (freins à disques/disc brake)	D/R	11->	NEW 554878		1814/1687	13368692-13350100

Véhicule Vehicle	Position	Année Year	SEIM P/n	Kit P/n	Longueur Lenght	OE
CHEVROLET/DAEWOO Suite...						
KALOS						
KALOS all model	G/L	03 -> 06	554076		1396/1200	96534871
	D/R	03 -> 06	554077		1383/1188	96534870
LACETTI						
LACETTI all model	G/L	03/04 ->	554081		1612/1364	9643511796808379
	D/R	03/04 ->	554080		1567/1320	9643511996808380
LANOS						
LANOS all model	Primaire Front	97 -> 04	554082		365	96232674
LANOS all model	G/L	97 -> 04	554083		1585/1350	D96230545-96230545
	D/R	97 -> 04	554084		1650/1410	D96245829-96245829
LEGANZA						
LEGANZA all model	G/L	97 -> 04	554085		1745/1535	96246680D96336080
	D/R	97 -> 04	554086		1745/1535	96246681D96336081
MATIZ						
MATIZ all model	Unique Single	98 -> 06/05	734300		2825/2x1216	96316682-96518396 -96482028
MATIZ II all model	Unique Single	06/05->09/09	NEW 554870		3013/2x1285	96666925
NUBIRA						
NUBIRA all model (freins à tambours/drum brake)	G/L	97 -> 04	554087		1642/1438	D96243462
	D/R	97 -> 04	554088		1654/1454	D96243463
NUBIRA all model (freins à disques/disc brake)	G/L	97 -> 04	554089		1578/1419	D96392000-96447013
	D/R	97 -> 04	554090		1603/1444	D96392001
NUBIRA all model (freins à disques/disc brake)	G/L	03/04 ->	554081		1612/1364	9643511796808379
	D/R	03/04 ->	554080		1567/1320	9643511996808380
ORLANDO						
ORLANDO all model	G/L	11->	NEW 554871		1873/1745	13356780
	D/R	11->	NEW 554872		1871/1745	13356781
SPARK						
SPARK 1.0 16v & 1.2 16v	G/L	01/10 ->	NEW 554879		1403/1213	96683000-95227771
SPARK 1.0 16v & 1.2 16v	D/R	01/10 ->	NEW 554880		1445/1250	95966825-95227772-95032308

CHRYSLER						
300 C						
300 C	Primaire Front	11/11 ->	NEW 555199		3145/3016	4779589AEK04779589AE
300 C	G/L	11/11 ->	NEW 555200		752/607	68066189AC-K68066189AC
	D/R	11/11 ->	NEW 555201		718/574	4779592AC-K04779592AC
VOYAGER & GRAND VOYAGER						
VOYAGER all model	G/L	91 -> 96	355001	855001	1080/820	4423789
	D/R	91 -> 96	355002		3100/2830	4720741
GRAND VOYAGER all model	G/L	91 -> 96	355002	855002	3100/2830	4720741
	D/R	91 -> 96	355004		3500/3240	4683388
VOYAGER & GRAND VOYAGER III & IV all model	Primaire Front	10/96 -> 03/08	NEW 554881		1510/905	00K04683285-4683285
VOYAGER & GRAND VOYAGER III & IV all model	Intermediate	10/96 -> 03/08	NEW 554882		1381/1277	00K04683286AF-4683286AD 4683286AB-4683286AC 4683286AD-4683286AF
VOYAGER & GRAND VOYAGER III & IV all model (freins à tambours/drum brake)	G/L	10/96 -> 03/08	NEW 554885		1620/873	00K04683299-4683299 4721027
	D/R	10/96 -> 03/08	Not available		1388/725	4683300-4683300AB 4683300AC-4721026
VOYAGER & GRAND VOYAGER III all model (freins à disques/disc brake)	G/L or D/R	10/96 -> 03/01	NEW 554886		1293/684	00K04721026AE

Véhicule Vehicle	Position	Année Year	SEIM P/n	Kit P/n	Longueur Lenght	OE
CHRYSLER						
<i>Suite...</i>						
VOYAGER & GRAND VOYAGER (suite)						
VOYAGER & GRAND VOYAGER IV all model (freins à disques/disc brake)	G/L	03/01 -> 03/08	NEW 554887		1692/842	00K04721027AK
	D/R	03/01 -> 03/08	NEW 554888		1292/685	00K04721026AH 00K04721026AK
VOYAGER & GRAND VOYAGER V all model (freins à disques/disc brake)	Primaire Front	03/08 ->	NEW 554890		2010/1742	00K04721495AC
VOYAGER & GRAND VOYAGER V all model	Primaire Front	03/08 ->	NEW 554889		2436/2003	00K04721808AC
VOYAGER & GRAND VOYAGER V all model (freins à disques/disc brake)	G/L	03/08 ->	NEW 554891		1347/1161	00K04779806AC 00K04721493AE 00K04779806AB
	D/R	03/08 ->	NEW 554892		4779807AB	00K04779807AC-4779807AB
CITROËN						
2CV						
2 CV all model sauf ourgonnette/exept van	G/L or D/R	l'orig -> 06/81	103000		400/165	AZ4541F
2 CV all model	G/L	06/81 ->	103050		653/515	75492021
	D/R	06/81 ->	103060		528/390	75491848-95493494
AX						
AX all model sauf/exept 4X4	G/L or D/R	09/86 -> 06/98	103610	803610	1395/1125	95604194-9560419480
AX 4X4	G/L or D/R	09/86 -> 06/98	103820		1418/1125	96044362-9604436280
BERLINGO						
BERLINGO (M49) all model (freins à tambours/drum brake)	G/L	01/97-> OPR 08393 (10/99)	103800	803800	1750/1410	4745X8-4745J0-9622250380
	D/R	01/97-> OPR 08393 (10/99)	103810		1810/1480	4745J3-9627711980
BERLINGO (M49/M59) all model sauf/ exept ESP (freins à tambours/drum brake)	G/L	OPR 08394 (11/99)-> 05/08	103800	804041	1750/1410	4745X8-4745J0-9622250380
	D/R	OPR 08394 (11/99)-> 05/08	104041		1850/1510	4745X9-4745R0-9639179280
BERLINGO (M59) avec/with ESP (freins à disques/disc brake)	G/L	11/02 -> 05/08	554042	805015	1820/1555	4745Y0-4745X2
	D/R	11/02 -> 05/08	554043		1922/1640	4745Y1-4745X3
BERLINGO III (B9) all model	G/L or D/R	06/08 ->	554044	805016	2402/1300	474646-9685249880
BX						
BX all model	G/L or D/R	82->	103550	803550	1635/1430	4745L2-9561150580-95496106
C1						
C1 all model	G/L	06/05 ->	204303	804303	1487/1243	4745Y3-464300H010
	D/R	06/05 ->	204304		1478/1235	4745Y2-464200H010
C2						
C2 all model (freins à tambours/drum brake)	G/L or D/R	09/03 ->	104100	804100	1612/800	474615-96803188-4745W3 96480848
C2 all model (freins à disques/disc brake)	G/L or D/R	09/03 ->	104110	804111	1700/935	474616-96803178-4745W4 4745Z0-9639346180
C3 & C3 PLURIEL						
C3 & C3 PLURIEL all model (freins à tambours/drum brake)	G/L or D/R	09/02-> OPR 10424 (05/05)	104060	804061	1716/867	4745V0-964320880
C3 & C3 PLURIEL all model (freins à tambours/drum brake)	G/L or D/R	OPR 10425 (06/05)->	554045	805017	1693/868	474613-4745Y9-968318380
C3 & C3 PLURIEL all model (freins à disques/disc brake)	G/L or D/R	09/02-> OPR 10424 (05/05)	104070	804071	1812/1003	4745V1
C3 & C3 PLURIEL all model (freins à disques/disc brake)	G/L or D/R	OPR 10425 (06/05)->	554046	805018	1790/1003	474614-9680318480
C3 II (A51)						
New C3 (A51) 1.0VTI-1.1-1.2 VTI-1.4i & 1.4HDI sauf/exept 1.4 VTI (freins à tambours/drum brake)	G/L or D/R	09/09 -> 11/09->	554758		1703/882	474658-9671815380

Véhicule Vehicle	Position	Année Year	SEIM P/n	Kit P/n	Longueur Length	OE
CITROËN Suite...						
C3 II (A51) (suite)						
New C3 (A51) 1.4 VTI (freins à tambours/drum brake)	G/L or D/R	09/09 ->	554759		1706/879	474659-9671814180
New C3 (A51) 1.6 VTI-1.6 HDI 90-92 & 110cv (freins à disques/disc brake)	G/L or D/R	09/09 ->	554760		1803/1024	474660-9671815180
C3 PICASSO						
C3 PICASSO all model (freins à disques/disc brake)	G/L or D/R	02/09->	554757		1913/1112	474654-9687063780
C4 & C4 II						
C4 all model	G/L or D/R	11/04 -> 07/08	204260	804261	2037/1182	474620-9661966980 4745T3-9636664680
C4 II (B7) all model sauf/except 2.0 HDI 140 cv	G/L or D/R	07/08 ->	554395		2033/1188	474631-9659391180
C4 II (B7) 2.0 HDI 140 cv	G/L or D/R	07/08 ->	554653		2069/1207	474667-9688480980
C4 II (B7) all model avec frein électrique/ with electric brake	Primaire Front		Not available			474676
C4 II (B7) 1.6VTi 1.6v 120cv-1.6THP155- 1.6HDI 110 & 115cv-2.0 HDI 150cv avec frein électrique/with electric brake	G/L or D/R		554673		829/666	474677
C4 PICASSO						
C4 PICASSO all model	Primaire Front	10/06 ->	Not available			474621
C4 PICASSO & Grand PICASSO all model	G/L	10/06 ->	NEW 554899			9676746080
	D/R	10/06 ->	NEW 554900			9676744080
C4 PICASSO all model avec frein électrique/ with electric brake	G/L	10/06 ->	554047	805019	928/750	4745Z7-474634-9683025580
	D/R	10/06 ->	554048		959/770	4745Z8-474635-9683025380
C5 & C5 II						
C5 all model	G/L or D/R	10/00 -> 04/08	104050	804051	1840/480	4745R5-9640271280
C5 II (X7) all model avec frein manuel/ with manual brake	G/L or D/R	04/08 ->	NEW 554901			474641-9682684580
C5 II (X7) all model avec frein électrique/ with electric brake	G/L or D/R	04/08 ->	Not available			
C8						
C8 all model avec silencieux AR longitudinal/ with longitudinal rear silencer	Primaire Front	06/02 -> OPR 10284 (01/05)	102440		500/305	474626-1400813180 4745E9-1472957080 4745T5-1487276080
C8 all model avec silencieux AR longitudinal/ with longitudinal rear silencer (freins à disques/ disc brake)	G/L	06/02 -> OPR 10284 (01/05)0	104090	804081	1068/840	4745T6-148727408
	D/R	06/02 -> OPR 10284 (01/05)	104080		2360/2220	4745T8-4745T7 1487647080-1487275080
C8 all model avec silencieux AR longitudinal & transversal/with longitudinal & transversal rear silencer	Primaire Front	02/05 ->OPR 11682	NEW 555212			474623-1400950680
C8 all model avec silencieux AR longitudinal & transversal/with longitudinal & transversal rear silencer	Primaire Front	OPR 11683 ->	NEW 554905			474652-1401441780
C8 all model avec silencieux AR longitudinal/with longitudinal rear silencer (freins à disques/disc brake)	G/L	OPR 10285 (02/05)-> 12/06	554050	805021	1041/840	474619-4745Y8-1400310380
	D/R	OPR 10285 (02/05)-> 12/06	554051		2308/2151	4745Y6-4745Y7 1400310280-1400310180
C8 all model avec silencieux AR transversal/with transversal rear silencer (freins à disques/disc brake)	G/L or D/R	01/06 ->	554108	805037	1257/1115	474609-1400204180
C-CROSSER						
C-CROSSER all model	G/L	07/07 ->	554053	805023		474632-4820A104
	D/R	07/07 ->	554054		474633-4820A103	
C15						
C15 fourgon all model sauf familiale & plancher cabine/except combi & cabin model	G/L or D/R	10/84 -> 11/97	103630	803630	1780/1320	95610161-95610162

Véhicule Vehicle	Position	Année Year	SEIM P/n	Kit P/n	Longueur Length	OE
CITROËN Suite...						
C15 (suite)						
C15 all model familiale & plancher cabine / combi & chassis cabs	G/L or D/R	10/84 -> 11/97	103830		1770/1030	95635771
C15 fourgon all model sauf familiale & plancher cabine/except combi & chassis cabs	G/L or D/R	12/97 -> 12/05	103970	803971	1720/1250	4745N6
C15 all model familiale & plancher cabine/ combi & chassis cabs	G/L or D/R	12/97 -> 12/05	103980	803981	1710/960	4745N7
C25						
C25 all model chassis normal/normal wheelbase	Primaire Front	09/81 -> 06/95	102420		1610/1410	474552
C25 all model Chassis rallongé/long wheelbase	Primaire Front	09/81 -> 06/95	102400		2340/2140	474554
C25 all model Combi 800 Kg	Primaire Front	09/81 -> 06/95	Not available		1660/1540	474579
C25 all model Plateau cabine/ Dump cabs 800 Kg	Primaire Front	09/81 -> 06/95	102390		2540/2410	4745A3-7660110
C25 all model sauf/except 800 Kg	Unique Single	09/81 -> 06/95	203750		2570/700x2	483476
C25 all model 800 Kg	Unique Single	09/81 -> 06/95	103960		2260/990x1010	474580-ZF07641374
C25 all model 4x4	Unique Single	09/81 -> 06/95	204290		2600/730x2	474596
C35						
C35 all model	Unique Single	01/73 -> 09/80	103500		930/677	95455064
C35 all model (Uniquement boîte 5 vitesses/ Only 5 speed)	Unique Single	09/80 -> 12/91	103600		1070/820	95495405
CX						
CX all model	G/L	06/80 -> 12/89	103560		1190/970	95492972
	D/R	06/80 -> 12/89	103570		1395/1175	95492971
DS3						
DS3 1,6HDI 90cv (freins à tambours/drum brake)	G/L or D/R	09/09 -> 11/09->	554758		1703/882	474658-9671815380
DS3 1.4 VTI 16v (freins à tambours/drum brake)	G/L or D/R	09/09 ->	554759		1706/879	474659-9671814180
DS3 1.6 VTI 16v - 1.6 THP16v - 1.6 HDI 110cv (freins à disques/disc brake)		09/09 ->	554760		1803/1024	474660-9671815180
DS4						
DS4 1.6 VTI & 1.6 HDI 110cv	G/L or D/R	07/08 ->	554395		2033/1188	474631-9659391180
DS4 2.0 HDI sans frein électrique/ without elctric brake	G/L or D/R	07/08 ->	554653		2069/1207	474667-9688480980
DS4 1.6VTi16v120cv-1.6THP150,155, 160 & 200cv-1.6HDI 110 & 115cv-2.0 HDI 135 & 160cv avec frein électrique/with elctric brake	G/L or D/R	07/08 ->	554673		829/666	474677
DS5						
DS5 all model	Primaire Front	06/11->	Not available			1606279880
DS5 all model sauf/except 2.0 HDI 160cv hybride	G/L	06/11->	554676			474679-474664 9672955480-9675503880
	D/R	06/11->	554677			474678-474665 9672955380-9675501780
DS5 2.0 HDI 160cv hybride	G/L or D/R	06/11->	NEW 554902			9801566780
DYANE & ACADIANE						
DYANE & ACADIANE all model (freins à tambours/drum brake)	G/L or D/R	01/67 -> 06/77	103000		400/165	AZ4541F
DYANE & ACADIANE all model (freins à disques/disc brake)	G/L	06/77 -> 12/83	103050		653/515	95493493-75492021
	D/R	06/77 -> 12/83	103060		528/390	75491848

Véhicule Vehicle	Position	Année Year	SEIM P/n	Kit P/n	Longueur Lenght	OE
CITROËN Suite...						
EVASION						
EVASION all model	Primaire Front	07/94 -> 07/02	102440		500/305	474626-1400813180 4745E9-1472957080 4745T5-1487276080
EVASION all model (freins à tambours/drum brake) sauf/except 1.8i+2.0i+2.0i16v+2.0i Turbo	G/L	07/94 -> 07/02	204060	804050	989/770	4745F2-1473322080-4745G9
	D/R	07/94 -> 07/02	204050		2290/2060	4745F3-1473321080
EVASION 1.8i+2.0i+2.0i16v+2.0i Turbo (freins à disques/disc brake)	G/L	07/94 -> 07/02	204070	804070	1250/1060	4745F4-1472959080
	D/R	07/94 -> 07/02	204080		2200/2070	4745F5-1472958080
GS & GSA						
GS & GSA all model	G/L	11/78 -> 07/86	Not available		765/590	4225401-4225402
	D/R	11/78 -> 07/86	Not available		775/600	4230001-4230002-5426165
JUMPER						
JUMPER all model	Primaire Front	02/94-> SERIE 16194399	202440		1059/761	4745G2-1308638080
JUMPER all model	Primaire Front	SERIE 16194400-> 02/02	202470		1078/762	4745V6-1336889080
JUMPER all model avec/with normal suspension sauf/except camping car	Unique Single	02/94-> SERIE 16158427	103770		3027/800x2	4745G3-1307963080
JUMPER all model avec/with normal suspension sauf/except camping car	Unique Single	SERIE 16158428 -> 16194399	204294		2810/860x2	4745V2-1330058080
JUMPER all model avec/with normal suspension sauf/except camping car (freins à tambours/drum brake)	Unique Single	SERIE 16194400>02/02	204295		2827/876x 876	4745V5-1337440080
JUMPER all model (freins à disques/disc brake)	Unique Single	SERIE 16194400>02/02	204296		2715/890x2	4745V4-4745V5 1339676080-1339394080
JUMPER camping car JUMPER avec/with reinforced suspension JUMPER équipé piste/off road equipment	Unique Single	02/94-> SERIE 16158427	103990		3040/810x2	4745G7-1314983080-4745X1
JUMPER camping car JUMPER avec/with reinforced suspension JUMPER équipé piste/off road equipment	Unique Single	SERIE 16158428>02/02	554056		2827/875x2	4745V3-1330066080
JUMPER 4x4 DANGEL	Primaire Front	02/94>02/02	202470		1078/762	4745V6-1336889080
JUMPER 4x4 DANGEL avec empattement court & moyen/with short & medium wheelbase sauf/except BV /gear box MLGU (freins à tambours/drum brake)	Unique Single	02/94>02/02	103770		3027/800x2	4745G3-1307963080
JUMPER 4x4 DANGEL avec empattement court & moyen/with short & medium wheelbase avec BV MLGU/with GB MLGU (freins à tambours/drum brake)	Unique Single	02/94>02/02	204294		2810/860x 860	4745V2-1330058080
JUMPER 4x4 DANGEL avec empattement long/with long wheelbase (freins à tambours/drum brake)	Unique Single	02/94>02/02	104000		4100/1410x 1410	4745J2
JUMPER 4x4 DANGEL avec empattement court/with short wheelbase simple lame/single blade REP 13 300 580 80 (freins à disques/disc brake)	Unique Single	02/94>02/02	204295		2827/876x 876	4745V5-1337440080
JUMPER 4x4 DANGEL avec empattement court/with short wheelbase double lame/double blade REP 13 300 660 80 & avec empattement moyen/with medium wheelbase simple lame/simple blade REP 13 079 630 80 (freins à disques/disc brake)	Unique Single	02/94>02/02	103770		3027/800x2	4745G3-1307963080
JUMPER 4x4 DANGEL avec empattement moyen/with medium wheelbase double lame/double blade REP 13 149 830 80 (freins à disques/disc brake)	Unique Single	02/94>02/02	103990		3040/810x2	4745G7-1314983080-4745X1
JUMPER 4x4 DANGEL avec empattement long/with long wheelbase (freins à disques/disc brake)	Unique Single	02/94>02/02	104000		4100/1410x 1410	4745J2

Véhicule Vehicle	Position	Année Year	SEIM P/n	Kit P/n	Longueur Lenght	OE
CITROËN Suite...						
JUMPER II						
JUMPER II VIN = VF3 sauf/except 4x4	Primaire Front	02/02->06/06	202470		1078/762	4745V6-1336889080
JUMPER II VIN = 936 sauf/except 4x4	Primaire Front	02/02->06/06	Not available		343	1609089780
JUMPER II VIN = 936 sauf/except 4x4	Primaire Front Front	02/02->06/06	Not available		693	1609089580
JUMPER II VIN = 936 sauf/except 4x4	Primaire Front Front	02/02->06/06	Not available		1200	1609089980
JUMPER II 4x4	Primaire Front Front	02/02->06/06	202440		1059/761	4745G2-1308638080
JUMPER II (freins à tambours/drum brake) sauf/except 4x4	Unique Single	02/02->06/06	204295		2827/876x 876	4745V5-1337440080
JUMPER II (freins à disques/disc brake)	Unique Single	02/02-> SERIE 17103012	204296		2715/890x2	4745V4-4745W5 1339676080-1339394080
JUMPER II (freins à disques/disc brake)	Unique Single	SERIE 17103013 -> 06/06	204296		2715/890x2	4745V4-4745W5 1339676080-1339394080
JUMPER II GPL & GNV	Primaire Front	02/02->06/06	554057		1463/645	4745W6-1338683080
JUMPER II GPL & GNV (freins à disques/disc brake)	G/L or D/R	02/02->06/06	554058	805024	955/782	4745W7-1338691080
JUMPER III						
JUMPER III Fourgon/Van JUMPER III Chassis cabine court/short chassis cabs	Primaire Front	06/06-> SERIE 11175965	554059		1908/1596	4745Z9-474647 1341023080-1359245080
JUMPER III Chassis moyen long & pavillon standard sauf chassis spécial /with medium long wheelbase & standard roof panel except spécial chassis	Primaire Front	06/06-> SERIE 11175965	554061		2648/2335	474629-1350314080 474650-1359247080
JUMPER III Chassis cabine/chassis cabs JUMPER III Chassis double cabine moyen/ Medium chassis with twincabs JUMPER III Chassis double cabine long/ Long chassis with twin cabs	Primaire Front	06/06-> SERIE 11175965	554060		2296/1981	474627-1350313080
JUMPER III Chassis cabine long/ with long chassis cabs JUMPER III Chassis double cabine rallongé/ chassis with stretched twin cabs	Primaire Front	06/06-> SERIE 11175965	554063		2910/2598	474628-1350315080 474649-1359248080
JUMPER III Fourgon/van JUMPER III Chassis Cabine court/ with short chassis cabs JUMPER III Chassis double cabine moyen/ medium chassis with twincabs	Primaire Front	SERIE 11175966 ->	554059		1908/1596	4745Z9-474647 1341023080-1359245080
JUMPER III Chassis Cabine moyen/ with medium chassis cabs	Primaire Front	SERIE 11175966->	554060		2296/1981	474627-1350313080 474648-1359246080
JUMPER III Chassis Cabine long/long chassis cabs JUMPER III Chassis Cabine rallongé/stretched chassis cabs JUMPER III Chassis double cabine rallongé/ stretched chassis cabs	Primaire Front	SERIE 11175966 ->	554063		2910/2598	474628-1350315080 474649-1359248080
JUMPER III Chassis moyen long & pavillon standard sauf chassis spécial /medium long chassis & standard roof panel except special chassis	Primaire Front	SERIE 11175966->	554061		2648/2335	474629-1350314080 474650-1359247080
JUMPER III sauf voie arrière élargie/ except rear track extended	G/L or D/R	06/06->	554062	805025	1390/1075	474617-1341031080
JUMPER III avec voie arrière élargie/ with rear track extended	G/L or D/R	06/06->	554064	805026	1485/1168	474618-1348980080

Véhicule Vehicle	Position	Année Year	SEIM P/n	Kit P/n	Longueur Lenght	OE
CITROËN						
<i>Suite...</i>						
JUMPY						
JUMPY I all model	Primaire Front	09/95 -> 12/06	102440		500/305	474626-1400813180-4745E9 1472957080-4745T5 1487276080
JUMPY I all model Chassis long/long wheel	Primaire Front	09/95 -> 12/06	102430		900/650	474624-1400813280 4745P0-1484375080
JUMPY I all model (freins à tambours/drum brake)	G/L	09/95 -> 12/06	204060	804050	989/770	4745F2-1473322080-4745G9
	D/R	09/95 -> 12/06	204050		2290/2060	4745F3-1473321080
JUMPY II						
JUMPY II & COMBI all model	Primaire Front	01/07 -> OPR 11682	NEW 555212			474623-1400950680
JUMPY II & COMBI all model	Primaire Front	OPR 11683->	NEW 554905			474652-1401441780
JUMPY II & COMBI all model (freins à tambours/drum brake)	G/L or D/R	01/07 -> OPR 11986	554655	805125	1494/1274	474610-1400203780
JUMPY II & COMBI all model (freins à tambours/drum brake)	G/L or D/R	OPR 11987->	554655	805125	1494/1274	474672-1440125280
JUMPY II & COMBI all model (freins à disques/disc brake)	G/L or D/R	01/07 ->	554052	805022	1613/1467	474611-1401352380 1400203680
JUMPY II & COMBI all model Chassis long/Long wheel (freins à disques/disc brake)	G/L or D/R	01/07 ->	554065	805027	1737/1591	474612-1400204880
LN & LNA						
LN & LNA all model	G/L or D/R	76 -> 07/82	203010		1230/640	7910015915
LN & LNA all model	G/L or D/R	07/82 -> 86	103520		1241/653	95495612-95495614
MEHARI						
MEHARI (freins à tambours/drum brake)	G/L or D/R	01/67 -> 06/77	103000		400/165	AZ4541F
MEHARI (freins à disques/disc brake)	G/L	06/77 -> 12/83	103050		653/515	95493493-75492021
	D/R	06/77 -> 12/83	103060		528/390	75491848
NEMO						
NEMO 1.4i	G/L	12/07 ->	554067	804029	1662/1407	474642-51784535
	D/R	12/07 ->	554068		1695/1442	474643-51784533
NEMO 1.4 HDI	G/L	12/07 ->	554069	805030	1610/1402	474644-51784536
	D/R	12/07 ->	554070		1710/1435	474645-51784534
SAXO						
SAXO 1.0i-1.1i-1.4i-1.6i-1.5D (freins à tambours/drum brake)	G/L or D/R	03/96 -> 12/04	103780	803780	1443/1121	4745T4-9620911080-4745H7 9620911080-4745J1 9625723180
SAXO 1.6i VTR-1.6i 16v VTS (freins à disques/disc brake)	G/L or D/R	03/96 -> 12/04	103840	803840	1510/1230	4745H8-96263856
VISA						
VISA all model (essence/gasoline & diesel)	G/L or D/R	09/78 -> 06/88	103260	803260	1421/748	474541-7910033436
XANTIA						
XANTIA & XANTIA break/ SW 1.8-2.0-1.9D-1.9TD	G/L	05/93 -> 09/02	103730	803730	1265/1130	4745G5-96121653
	D/R	05/93 -> 09/02	103740		1335/1200	4745G6-96121652
XANTIA & XANTIA break/SW 2.0 TURBO- 2.1TD & HDI (BVM MLST)	G/L	05/93 -> 09/02	103790		1313/1215	4745H5-9622062780
	D/R	05/93 -> 09/02	103740		1330/1240	4745G6-96121652
XANTIA V6	G/L	05/93 -> 09/02	103790		1313/1215	4745H5-9622062780
	D/R	05/93 -> 09/02	103950		1364/1266	4745J4-9627411980
XANTIA 1.8 BVA	G/L	05/93 -> 09/02	103741	803740	1285/1185	4745N3-9631004480
	D/R	05/93 -> 09/02	103740		1330/1240	4745G6-96121652
XM						
XM all model	Primaire Front	07/89 -> 03/01	103680		1410/1100	96012379-9601237980
XM all model sauf/except V6 24S	G/L	07/89 -> 03/01	103650	803650	1027/894	96026875-9602687580
	D/R	07/89 -> 03/01	103660		1227/1094	96026873-9602687380

Véhicule Vehicle	Position	Année Year	SEIM P/n	Kit P/n	Longueur Lenght	OE
CITROËN Suite...						
XM (suite)						
XM V6 24S	G/L	07/89 -> 03/01	Not available		1026/900	96092671-96092761 9609276180
	D/R	07/89 -> 03/01	Not available		1390/1300	96068340-9606834080
XSARA I & II						
XSARA I & II all model sauf/except break/SVV (freins à tambours/drum brake)	G/L	07/97 -> 11/04	103910	803910	1593/1275	4745J8-9632525980
	D/R	07/97 -> 11/04	103920		1503/1185	4745J9-9632526280
XSARA break/SVV all model I & II (freins à tambours/drum brake)	G/L	07/97 -> 11/04	104030	804031	1610/1260	4745K2-9632190280
	D/R	07/97 -> 11/04	104040		1520/1170	4745K3-9632190380
XSARA I & II y compris/include break/SVV (freins à disques/disc brake)	G/L	07/97 -> 11/04	103930	803940	1630/1370	4745K0-9632647880
	D/R	07/97 -> 11/04	103940		1540/1280	4745K1-9632647980
XSARA PICASSO						
XSARA PICASSO all model (freins à tambours/drum brake)	G/L	12/99 -> DAM 1186578 (05/09)	104010	804011	1770/1500	4745P5-9633826680
	D/R	12/99 -> DAM 1186578 (05/09)	104020		1870/1590	4745P6-9633826780
XSARA PICASSO all model (freins à tambours/ drum brake)	G/L	DAM 1186578 (05/09) ->	NEW 554906		1860/1645	474638-9664440680
	D/R	DAM 1186578 (05/09) ->	NEW 554907		1948/1735	474639-9664440780
XSARA PICASSO all model	G/L	11/02 ->	554074	805032	1860/1645	4745Z5-9659013080 9659013980
	D/R	11/02 ->	554075		1950/1735	4745Z6-9659014080 4745W1-9643731980
ZX						
ZX all model sauf break/except SW (freins à tambours/drum brake)	G/L	03/91 -> OPR 07330 (12/96)	103700	803690	1590/1260	4745F8-9603256580
	D/R	03/91 -> OPR 07330 (12/96)	103690		1500/1170	4745G1-9603256480
ZX all model sauf break/except SW (freins à tambours/drum brake)	G/L	OPR 07331 (12/96) -> 06/98	103850	803860	1580/1260	4745K4-9628847080
	D/R	OPR 07331 (12/96) -> 06/98	103860		1490/1170	4745K5-9628846980
ZX break/SVV all model (freins à tambours/drum brake)	Kit G/L + D/R	03/91 -> OPR 07330 (12/96)	554658	KIT	L:1620/ 1265 R:1530/ 1175	4745E8=4745F7-9614573980+ 4745G0-9614574080
ZX all model break/SVV all model (freins à tambours/drum brake)	G/L	OPR 07331 (12/96) -> 06/98	103890	803890	1610/1260	4745K8-9628847380
	D/R	OPR 07331 (12/96) -> 06/98	103900		1520/1170	4745K9-9628847480
ZX 1.9i & 2.0i 16v Volcane (freins à disques/disc brake)	G/L	03/91 -> OPR 07330 (12/96)	103710	803720	1620/1340	4745F6-9603256080
	D/R	03/91 -> OPR 07330 (12/96)	103720		1540/1270	4745F9-9603256180
ZX 1.9i & 2.0i 16v Volcane (freins à disques/disc brake)	G/L	OPR 07331 (12/96) -> 06/98	103870	803871	1600/1340	4745K6-9628847180
	D/R	OPR 07331 (12/96) -> 06/98	103880		1520/1260	4745K7-9628847280
DACIA						
DOKKER						
DOKKER 1.2 TCE 115cv-1.5 MPI 85cv & 1.5 DCI 75 & 90cv	G/L or D/R	09/12 ->	555152		1953/1734	364007536R-364007537R
LODGY						
LODGY 1.2 TCE 115cv-1.5 MPI 85cv & 1.5 DCI 90cv	G/L or D/R	01/12 ->	555152		1953/1734	364007536R-364007537R

Véhicule Vehicle	Position	Année Year	SEIM P/n	Kit P/n	Longueur Length	OE
DACIA Suite...						
LOGAN						
LOGAN all model avec direction assistée/with power steering (freins à tambours/drum brake)	G/L or D/R	06/05 ->	404988	804988	1680/1500	6001547168-8200215962
LOGAN all model sans direction assistée/without power steering (freins à tambours/drum brake)	G/L or D/R	06/05 ->	554647	805127	1667/1498	6001547169-8200380738
LOGAN MCV all model (freins à tambours/drum brake)	G/L or D/R	01/07 ->	554091	805033	1993/1770	6001549112-8200415004
LOGAN VAN all model	G/L or D/R	01/08 -> 09/12	554091	805033	1993/1770	6001549112-8200415004
LOGAN PICK-UP all model	G/L or D/R	01/09 -> 07/12	554091	805033	1993/1770	6001549112-8200415004
LOGAN II all model	G/L or D/R	10/12 ->	404988	804988	1680/1500	6001547168
SANDERO						
SANDERO all model	G/L or D/R	06/08 -> 09/12	554092	805034	1658/1478	8200745723
SANDERO II all model	G/L or D/R	10/12 ->	NEW 555204			364005982
DUSTER						
DUSTER all model 4X2 (freins à tambours/drum brake)	G/L or D/R	03/10 ->	NEW 554908		1787/1561	364002234R-8200820595
DUSTER all model 4x4 (freins à disques/disc brake)	G/L or D/R	03/10 ->	NEW 554909		1720/1502	364003676R-8200855403
FIAT						
500 II & 500 L						
500 II 1.2-1.3 MJTD (freins à tambours/drum brake)	G/L	07/07 ->	554659		1425/1176	51786840
	D/R	07/07 ->	554660		1450/1202	51786839
500 II 1.4i 16V & 1.4i 16V (135 & 160 cv)	G/L	07/07 ->	554661		1491/1271	51753526-51826362
ABARTH (freins à disques/disc brake)	D/R	07/07 ->	554662		1506/1291	51753527-51826363
500 L	G/L or D/R	12 ->	NEW 555202		1778/1552	51963351-51931536-51931537
BRAVA & BRAVO						
BRAVA / BRAVO all model	Primaire Front	09/95 -> 12/01	702250		390	7773616
BRAVA / BRAVO 1.4i 12V & 1.9D (freins à tambours/drum brake)	G/L	09/95 -> 12/01	703310	803310	1420/1050	46468158-7773001-46462766
	D/R	09/95 -> 12/01	703320		1370/990	46468157-7773000-46455422
BRAVA / BRAVO 1.6 16v 1.8 1.9TD 75 & 100cv (freins à tambours/drum brake)	G/L	09/95 -> 12/01	703350	803360	1430/1050	46468156-7791233-46465947
	D/R	09/95 -> 12/01	703360		1380/990	46737015-7791231 46468155-46465194
BRAVA / BRAVO 2L 20V (freins à disques/disc brake)	G/L	09/95 -> 12/01	703390	803390	1500/1150	46465948-46460508
	D/R	09/95 -> 12/01	703400		1450/1110	46460478-46414289-46465949
BRAVO II all model (freins à disques/disc brake)	G/L	03/07 ->	703495		1780/1590	51702642-46819335
	D/R	03/07 ->	554093		1669/1470	51718093
CINQUECENTO						
CINQUECENTO all model	Unique Single	07/92 -> 09/98	703100		2990/1190/ 1230	7684513
COUPE						
COUPE all model	Primaire Front	01/95 ->	702240		406	7609367-46410282-92323732
COUPE all model	G/L	01/95 ->	703490		1510/1180	60812546-46401730
	D/R	01/95 ->	554094		1473/1120	46401725
CROMA						
CROMA all model	Primaire Front	05/86 -> 09/96	554004		275	60807617-82399827
CROMA all model	Unique Single	05/86 -> 09/96	703110		2950/1235/ 1375	82441688-82390671-6081383
CROMA II all model	Unique Single	06/05 ->	554096		1570/1398+ 1627/1456	51753207-51753208
DOBLO						
DOBLO I 4 portes/doors	G/L	03/01-> 12/05	703461		1810/1475	46766308-46766309
	D/R	03/01-> 12/05	554097		1788/1458	46835328

Véhicule Vehicle	Position	Année Year	SEIM P/n	Kit P/n	Longueur Lenght	OE
FIAT						
DOBLO (suite)						
DOBLO I 5 portes/doors 1.2i-1.6 16v-1.3MJTD-1.9D-1.9JTD	G/L	03/01-> 12/05	703461		1810/1475	46766309-46766308
	D/R	03/01-> 12/05	554097		1788/1458	46835328
DOBLO I 5 portes/doors 1.4i-1.3MJTD-1.9MJTD 105 & 120cv	G/L	01/06-> 12/09	703461		1810/1475	46766309-46766308
	D/R	01/06-> 12/09	554097		1788/1458	46835328
DOBLO I CARGO 3, 4, 5 portes/doors all model sauf/except Maxi	G/L	03/01-> 12/05	703492		1755/1465	46745157-46745155
	D/R	03/01-> 12/05	554098		1741/1448	46835327
DOBLO & DOBLO CARGO 1.6 GNV ou GPL Bipower	G/L or D/R	03/01-> 12/05	NEW 554910		1780/1482	51706677
DOBLO & DOBLO CARGO 1.6 GNV ou GPL Bipower	G/L or D/R	10/05-> 01/10	NEW 554918		2137/1837	51816315
DOBLO I & DOBLO I CARGO sauf/except Maxi	G/L or D/R	10/05-> 01/10	703492		1755/1465	46745157-46745155
DOBLO CARGO I Maxi all model	G/L	10/05-> 01/10	554099	805035	2140/1844	51750481
	D/R	10/05-> 01/10	554100		2140/1844	51750480
DOBLO COMBI I Maxi all model	G/L	10/05-> 01/10	NEW 554917		2120/1785	51796642
	D/R	10/05-> 01/10	NEW 554916		2135/1792	51796639
DOBLO II						
DOBLO II all model sauf/except Bipower	G/L or D/R	01/10->	NEW 554911		1833/1552	51882838-51868727
DOBLO II all model avec frein AR spécifique/ with specific rear brake sauf/except Bipower	G/L or D/R	01/10->	NEW 554912		1850/1567	51882836-51868725
DOBLO II 1.4i GNV ou GPL Bipower	G/L or D/R	01/10->	NEW 554913		1872/1585	51882839
DOBLO II Maxi all model sauf/except Bipower	G/L or D/R	01/10->	NEW 554914		2182/1898	51882837-51868726
DOBLO II Maxi 1.4i GNV ou GPL Bipower	G/L or D/R	01/10->	NEW 554915		2223/1938	51882840
DUCATO						
DUCATO I Chassis normal/normal wheel	Primaire Front	09/81-> 02/94	102420		1610/1410	7359202-474552
DUCATO I Chassis rallongé/long wheel	Primaire Front	09/81-> 02/94	102400		2340/2140	5925334-474554
DUCATO I Combi 800 Kg	Primaire Front	09/81-> 02/94	Not available		1660/1540	474579
DUCATO I plateau cabine/cabin wheel 800 Kg	Primaire Front	09/81-> 02/94	102390		2540/2410	7660110-4745A3
DUCATO I all model sauf/except 800 Kg	Unique Single	09/81-> 02/94	203750		2570/700x2	4450938-483476
DUCATO I all model 800 Kg	Unique Single	09/81-> 02/94	103960		2260/990x 1010	ZF07641374-474580
DUCATO I all model 4X4	Unique Single	09/81-> 02/94	204290		2600/730x2	474596
DUCATO all model	Primaire Front	02/94-> SERIE 16194399	202440		1059/761	4745G2-1308638080
DUCATO all model	Primaire Front	SERIE 16194400-> 02/02	202470		1078/762	4745V6-1336889080
DUCATO all model avec/with normal suspension sauf/except camping car	Unique Single	02/94-> SERIE 16158427	103770		3027/800x2	4745G3-1307963080
DUCATO all model avec/with normal suspension sauf/except camping car	Unique Single	SERIE 16158428-> 16194399	204294		2810/860x2	4745V2-1330058080
DUCATO all model avec/with normal suspension sauf/except camping car (freins à tambours/ drum brake)	Unique Single	SERIE 16194400->02/02	204295		2827/876x 876	4745V5-1337440080
DUCATO all model (freins à disques/disc brake)	Unique Single	SERIE 16194400->02/02	204296		2715/890x2	4745V4-4745W5 1339676080-1339394080
DUCATO camping car DUCATO avec/with reinforced suspension DUCATO équipé piste/off road equipment	Unique Single	02/94-> SERIE 16158427	103990		3040/810x2	4745G7-1314983080-4745X1
DUCATO camping car DUCATO avec/with reinforced suspension DUCATO équipé piste/off road equipment	Unique Single	SERIE 16158428-> 02/02	554056		2827/875x2	4745V3-1330066080

Véhicule Vehicle	Position	Année Year	SEIM P/n	Kit P/n	Longueur Length	OE
FIAT Suite...						
DUCATO (suite)						
DUCATO 4x4 DANGEL	Primaire Front	02/94>02/02	202470		1078/762	4745V6-1336889080
DUCATO 4x4 DANGEL avec empattement court & moyen/with short & medium wheelbase sauf BV / except gear box MLGU (freins à tambours/drum brake)	Unique Single	02/94>02/02	103770		3027/800x2	4745G3-1307963080
DUCATO 4x4 DANGEL avec empattement court & moyen/with short & medium wheelbase avec BV /with gear box MLGU (freins à tambours/drum brake)	Unique Single	02/94>02/02	204294		2810/860x 860	4745V2-1330058080
DUCATO 4x4 DANGEL avec empattement long/with long wheelbase (freins à tambours/drum brake)	Unique Single	02/94>02/02	104000		4100/1410x 1410	4745J2
DUCATO 4x4 DANGEL avec empattement court/with short wheelbase simple lame/single blade REP 13 300 580 80 (freins à disques/disc brake)	Unique Single	02/94>02/02	204295		2827/876x 876	4745V5-1337440080
DUCATO 4x4 DANGEL avec empattement court/with short wheelbase double lame/double blade REP 13 300 660 80 & avec empattement moyen/with medium wheelbase simple lame/simple blade REP 13 079 630 80 (freins à disques/disc brake)	Unique Single	02/94>02/02	103770		3027/800x2	4745G3-1307963080
DUCATO 4x4 DANGEL avec empattement moyen/with medium wheelbase double lame/double blade REP 13 149 830 80 (freins à disques/disc brake)	Unique Single	02/94>02/02	103990		3040/810x2	4745G7-1314983080-4745X1
DUCATO 4x4 DANGEL avec empattement long/with long wheelbase (freins à disques/disc brake)	Unique Single	02/94>02/02	104000		4100/1410x 1410	4745J2
DUCATO II						
DUCATO II VIN = VF3 sauf/except 4x4	Primaire Front	02/02>06/06	202470		1078/762	4745V6-1336889080
DUCATO II VIN = 936 sauf/except 4x4	Primaire Front	02/02>06/06	Not available		343	1609089780
DUCATO II VIN = 936 sauf/except 4x4	Primaire Front	02/02>06/06	Not available		693	1609089580
DUCATO II VIN = 936 sauf/except 4x4	Primaire Front	02/02>06/06	Not available		1200	1609089980
DUCATO II 4x4	Primaire Front	02/02>06/06	202440		1059/761	4745G2-1308638080
DUCATO II (freins à tambours/drum brake) sauf/except 4x4	Unique Single	02/02>06/06	204295		2827/876x 876	4745V5-1337440080
DUCATO II (freins à disques/disc brake)	Unique Single	02/02> SERIE 17103012	204296		2715/890x2	4745V4-4745W5 1339676080-1339394080
DUCATO II (freins à disques/disc brake)	Unique Single	SERIE 17103013 > 06/06	204296		2715/890x2	4745V4-4745W5 1339676080-1339394080
DUCATO II GPL & GNV	Primaire Front	02/02>06/06	554057		1463/645	4745W6-1338683080
DUCATO II GPL & GNV (freins à disques/disc brake)	G/L or D/R	02/02>06/06	554058	805024	955/782	4745W7-1338691080
DUCATO III						
DUCATO III Fourgon/Van	Primaire Front	06/06> SERIE 11175965	554059		1908/1596	4745Z9-474647 1341023080-1359245080
DUCATO III Chassis cabine court/short chassis cabs	Primaire Front	06/06> SERIE 11175965	554061		2648/2335	474629-1350314080 474650-1359247080

Véhicule Vehicle	Position	Année Year	SEIM P/n	Kit P/n	Longueur Length	OE
FIAT						
DUCATO III (suite)						
DUCATO III Chassis cabine/chassis cabs DUCATO III Chassis double cabine moyen/ Medium chassis with twincabs DUCATO III Chassis double cabine long/Long chassis with twin cabs	Primaire Front	06/06-> SERIE 11175965	554060		2296/1981	474627-1350313080
DUCATO III Chassis cabine long/with long chassis cabs DUCATO III Chassis double cabine rallongé/ chassis with stretched twin cabs	Primaire Front	06/06-> SERIE 11175965	554063		2910/2598	474628-1350315080 474649-1359248080
DUCATO III Fourgon/van DUCATO III Chassis Cabine court/ with short chassis cabs DUCATO III Chassis double cabine moyen/ medium chassis with twincabs	Primaire Front	SERIE 11175966 ->	554059		1908/1596	474529-474647 1341023080-1359245080
DUCATO III Chassis Cabine moyen/ with medium chassis cabs	Primaire Front	SERIE 11175966->	554060		2296/1981	474627-1350313080 474648-1359246080
DUCATO III Chassis Cabine long/long chassis cabs DUCATO III Chassis Cabine rallongé/ stretched chassis cabs DUCATO III Chassis double cabine rallongé/ stretched chassis cabs	Primaire Front	SERIE 11175966 ->	554063		2910/2598	474628-1350315080 474649-1359248080
DUCATO III Chassis moyen long & pavillon standard sauf chassis spécial /medium long chassis & standard roof panel except special chassis	Primaire Front	SERIE 11175966->	554061		2648/2335	474629-1350314080 474650-1359247080
DUCATO III sauf voie arrière élargie/ except rear track extended	G/L or D/R	06/06->	554062	805025	1390/1075	474617-1341031080
DUCATO III avec voie arrière élargie/ with rear track extended	G/L or D/R	06/06->	554064	805026	1485/1168	474618-1348980080
FIORINO						
FIORINO 900, 1050	Unique Single	77 -> 88	703080		2310/820x 820	4261125-4261126
FIORINO D	Unique Single	-> 88	703230		2310/820x 820	4362077
FIORINO D	Unique Single	88 -> 93	703220		2830/1160x 1160	5969735
FIORINO ESS	Unique Single	88 -> 93	703493		2840/1175x 1175	7522590
FIORINO all model	Unique Single	93 -> 01	703494		3105/1205x 1205	7739156
FIORINO II						
FIORINO II / QUBO 1.4i	G/L	12/07 ->	554067	805029	1662/1407	51784535-474642
	D/R	12/07 ->	554068		1695/1442	51784533-474643
FIORINO II / QUBO 1.3 MJTD	G/L	12/07 ->	554069	805030	1610/1402	51784536-474644
	D/R	12/07 ->	554070		1710/1435	51784534-474645
FREEMONT						
FREEMONT all model	Primaire Front	06/11->	NEW 554919		1920/1655	00K04766479AD 00K04766479AC
FREEMONT all model	G/L	06/11->	NEW 554920		1177/980	00K04862227AJ 00K04862227AH 00K04862227AG 00K04862227AI
	D/R	06/11->	NEW 554921		2303/2095	00K04862226AG 00K04862226AF 00K04862226AE

Véhicule Vehicle	Position	Année Year	SEIM P/n	Kit P/n	Longueur Length	OE
FIAT						
						<i>Suite...</i>
IDEA						
IDEA 1.2-1.4 16v & 1.3 MJTD (70cv)	G/L or D/R	01/04 ->	703463	803463	1535/1295	51770286-51731443
IDEA 1.3 MJTD (90 cv) & 1.9 MJTD	G/L or D/R	01/04 ->	703462	803462	1557/1295	51770287-46847434
IDEA 1.6 MJTD	G/L or D/R	01/04 ->	554101		1618/1423	51804860
LINEA						
LINEA all model	G/L	03/07 ->	NEW 554922		1712/1437	51785645
	D/R	03/07 ->	NEW 554923		1725/1450	51785644
LINEA all model (freins à disques/disc brake)	G/L	03/07 ->	NEW 554924		1520/1315	51787025
	D/R	03/07 ->	NEW 554925		1528/1320	51787024
MAREA						
MAREA all model sauf/except MAREA SW	Primaire Front	09/96 -> 12/02	702250		390	7773616
MAREA 1.4i-1.2V & 1.9D sauf/except MAREA SW	G/L	09/96 -> 12/02	703310	803310	1420/1050	46468158-7773001-46462766
	D/R	09/96 -> 12/02	703320		1370/990	46468157-7773000-46455422
MAREA 1.6-1.8 & 1.9TD (75 & 100cv) sauf/except MAREA SW	G/L	09/96 -> 12/02	703350	803360	1430/1050	46468156-7791233-46465947
	D/R	09/96 -> 12/02	703360		1380/990	46737015-7791231 46465194-46468155
MAREA SVV 1.6-1.8 & 1.9TD (75 & 100cv)	G/L	09/96 -> 12/02	703410	803410	1460/1060	46463910-60813764-7773015
	D/R	09/96 -> 12/02	703420		1400/1000	46463911
MAREA & MAREA SW 2.0i & 2.4 JTD 130cv (freins à disques/disc brake)	G/L	09/96 -> 12/02	703390	803310	1500/1150	46460508-46465948
	D/R	09/96 -> 12/02	703400		1450/1110	46460478-46414289-46465949
MULTIPLA						
MULTIPLA all model	Primaire Front	01/99 -> 09/08	554102		685	46514278
MULTIPLA all model sans/without ESP (freins à tambours/drum brake)	G/L	01/99 -> 09/08	703450	803460	1165/820	46757058-46511039
	D/R	01/99 -> 09/08	703460		2014/1670	46547547
MULTIPLA all model avec/with ESP (freins à disques/disc brake)	G/L	01/99 -> 09/08	703467	803466	1220/930	46814147
	D/R	01/99 -> 09/08	703466		2081/1790	46814148
MULTIPLA 1.6 16V GPL	G/L	01/99 -> 09/08	703464	803464	1143/800	60654885
	D/R	01/99 -> 09/08	703465		2063/1718	60664187
MULTIPLA all model		10/08 ->	Not available			
PALIO & SIENA						
PALIO & SIENA all model	G/L	03/98 -> 12/02	703430	803440	1520/1290	46431514-46542604
	D/R	03/98 -> 12/02	703440		1470/1240	46464658
PALIO & SIENA all model (freins à tambours/drum brake)	G/L	12/02->	NEW 555198		1501/1277	46847416
	D/R	12/02->	NEW 554926		1511/1284	46847417
PALIO & SIENA all model	G/L	12/02->	NEW 554927		1400/1153	46799091-46799093 7798268-46437961
	D/R	12/02->	NEW 554927		1400/1153	46799093-46799091 7798268-46437961
PANDA						
PANDA all model	Unique Single	80 -> 10/85	703000		2690/2x1000	4406021
PANDA all model sauf/except 4X4	Unique Single	11/85 -> 01/93	703090		2385/2x946	7573814
PANDA all model sauf/except 4X4	Unique Single	01/93 -> 08/03	703240		2380	7757560
PANDA 4X4 all model	Unique Single	11/85 -> 09/04	703000		2690/2x1000	4406021
PANDA II 1.1, 1.2 & 1.3 MJTD 70cv sauf/except 4X4 (freins à tambours/drum brake)	G/L	09/03 -> 10/06	703452	803451	1400/1165	51708686
	D/R	09/03 -> 10/06	703451		1430/1190	51708685
PANDA II 1.2 GNV sauf/except 4X4 (freins à tambours/drum brake)	G/L	09/03->	554103	805036	1437/1178	51787260
	D/R	09/03->	554104		1457/1194	51787259
PANDA II 1.3 MJTD 75cv sauf/except 4X4 (freins à tambours/drum brake)	G/L	09/03->	NEW 554930		1403/1154	51776597
	D/R	09/03->	NEW 554931		1430/1182	51776598
PANDA II 1.4 16V sauf/except 4X4 (freins à disques/disc brake)	G/L	09/03->	554661		1491/1271	51753526-51826362
	D/R	09/03->	554662		1506/1291	51753527-51826363

Véhicule Vehicle	Position	Année Year	SEIM P/n	Kit P/n	Longueur Lenght	OE
FIAT						
<i>Suite...</i>						
PANDA (suite)						
PANDA II 4X4 all model	G/L	09/03 ->	554105		1485/1270	46829767
	D/R	09/03 ->	554106		1471/1258	46829766
PANDA II CROSS 4X4 all model	G/L	01/06 ->	554105		1485/1270	46829767
	D/R	01/06 ->	554106		1471/1258	46829766
PANDA III all model	G/L	01/12->	NEW 554928		1427/1157	51900393
	D/R	01/12->	NEW 554929		1437/1166	51900391
PUNTO I						
PUNTO all model sauf/except GT & ABS (freins à tambours/drum brake)	G/L	09/93 -> 09/99	703190	803190	1456/1290	7747332
	D/R	09/93 -> 09/99	703180		1469/1290	7747331
PUNTO & PUNTO GT all model avec/with ABS (freins à disques/disc brake)	G/L or D/R	09/93 -> 09/99	703200		1527/1410	7747333-7747334
PUNTO II						
PUNTO II all model sauf/except 1.2 60 1.2 16v 80-80D & 1.9JTD 80, 85cv (freins à tambours/drum brake)	G/L or D/R	10/99 -> 05/03	703470	803470	1456/1225	46752977-46752983
PUNTO II all model sauf/except 1.2 60 1.2 16v 80cv-1.3MJTD 70cv-1.9JTD 85cv (freins à tambours/drum brake)	G/L or D/R	05/03 -> 10/09	703470	803470	1456/1225	46752977-46752983
PUNTO II 1.4 16v 95cv (freins à tambours/drum brake)	G/L or D/R	05/03 -> 10/09	703453	803453	1467/1230	46845902
PUNTO II all model & 1.8 16V 130cv & 1.9JTD 100cv (freins à disques/disc brake)	G/L or D/R	10/99 -> 10/09	703480	803480	1580/1390	46552978
GRANDE PUNTO						
GRANDE PUNTO 1.2 8V (freins à tambours/drum brake)	G/L	10/05 ->	703504	803504	1640/1380	55704107-55700928
	D/R	10/05 ->	703505		1650/1400	55704105-55700926
GRANDE PUNTO 1.3 JTD 1.9JTD 90 cv 1.4 8V 1.4 16V sauf/except Sport	G/L	10/05 ->	703506	803506	1670/1380	55704108-55701942
	D/R	10/05 ->	703507		1680/1400	55704106-55701946
GRANDE PUNTO 1.4 16v Sport, ABARTH, 1.9 JTD 120 & 130cv (freins à disques/disc brake)	G/L	10/05 ->	NEW 554860	803502	1650/1420	51844531-55704104-55700929
	D/R	10/05 ->	NEW 554861		1673/1440	51871598-51871599 55700927-55704103
PUNTO EVO						
PUNTO EVO 1.2 65 & 69cv (freins à tambours/drum brake)	G/L	10/09 ->	703504	803504	1640/1380	55704107-55700928
	D/R	10/09 ->	703505		1650/1400	55704105-55700926
PUNTO EVO 1.4 70cv 1.4 16V 105cv & 1.3 MJTD	G/L	10/09 ->	703506	803506	1670/1380	55704108-55701942
	D/R	10/09 ->	703507		1680/1400	55704106-55701946
PUNTO EVO 1.4 16v 105 & 135cv & 1.6 MJTD 120cv (freins à disques/disc brake)	G/L	10/05 ->	NEW 554860	803502	1650/1420	51844531-55704104-55700929
	D/R	10/05 ->	NEW 554861		1673/1440	51871598-51871599 55700927-55704103
PUNTO III						
PUNTO III 0.9 TwinAir 85cv & 1.2 69cv (freins à tambours/drum brake)	G/L	01/12 ->	703504	803504	1640/1380	55704107-55700928
	D/R	01/12 ->	703505		1650/1400	55704105-55700926
PUNTO III 1.3 MJTD	G/L	01/12 ->	703506	803506	1670/1380	55704108-55701942
	D/R	01/12 ->	703507		1680/1400	55704106-55701946
PUNTO III 1.4 16v 105 & 135cv & 1.6 MJTD 120cv (freins à disques/disc brake)	G/L	10/05 ->	NEW 554860	803502	1650/1420	51844531-55704104-55700929
	D/R	10/05 ->	NEW 554861		1673/1440	51871598-51871599 55700927-55704103
QUBO						
QUBO 1.4i	G/L	12/07 ->	554067	803529	1662/1407	51784535-474642
	D/R	12/07 ->	554068		1695/1442	51784533-474643
QUBO 1.3 MJTD	G/L	12/07 ->	554069	803530	1610/1402	51784536-474644
	D/R	12/07 ->	554070		1710/1435	51784534-474645
REGATA						
REGATA all model	Primaire Front	09/83 -> 12/89	703050		405	5939142
	Unique Single	09/83 -> 12/89	703060		3510/490 x490	5939145

Véhicule Vehicle	Position	Année Year	SEIM P/n	Kit P/n	Longueur Lenght	OE
FIAT						
RITMO						
RITMO all model	Primaire Front	10/82 ->	703050		405	5939142
RITMO all model Sauf cabriolet/ except convertible	Unique Single	10/82 ->	703060		3510/490 x490	5939145
SCUDO I & II						
SCUDO I & II all model	Primaire Front	10/95 -> 12/06	102440		500/305	1400813180-1487276080 1472957080-474626-4745E9 4745T5
SCUDO I & II all model chassis long/long wheel	Primaire Front	10/95 -> 12/06	102430		900/650	1400813280-1484375080 474624-4745P0
SCUDO I & II all model (freins à tambours/ drum brake)	G/L	10/95 -> 12/06	204060	804050	989/770	1473322080-4745F2-4745G9
	D/R	10/95 -> 12/06	204050		2290/2060	1473321080-4745F3
SCUDO I & II all model (freins à disques/disc brake)	G/L	10/95 -> 12/06	204070	804070	1250/1060	1472959080-4745 F4
	D/R	10/95 -> 12/06	204080		2200/2070	1472958080-4745 F5
SCUDO III						
SCUDO III all model	Primaire Front	01/07 -> OPR 11682	NEW 555212			474623-1400950680
SCUDO III all model	Primaire Front	OPR 11683->	NEW 554905			474652-1401441780
SCUDO III all model (freins à tambours/drum brake)	G/L or D/R	01/07 -> OPR 11986	554655	805125	1494/1274	474610-1400203780
SCUDO III all model (freins à tambours/drum brake)	G/L or D/R	OPR 11987->	554655	805125	1494/1274	474672-1440125280
SCUDO III all model (freins à disques/disc brake)	G/L or D/R	01/07 ->	554052	805022	1613/1467	474611-1401352380 1400203680
SCUDO III all model chassis long/long wheel (freins à disques/disc brake)	G/L or D/R	01/07 ->	554065	805027	1737/1591	1400204880-474612
SEDICI						
SEDICI all model (freins à tambours/drum brake)	G/L	04/06 -> 12/09	554695		1787/1542	71742845-5440279J00
	D/R	04/06 -> 12/09	554696		1797/1548	71742844-5440179J00
SEDICI all model (freins à disques/disc brake)	G/L	09/09 ->	NEW 554932		1638/1458	71750425-5440255L10
	D/R	09/09 ->	NEW 554933		1638/1458	71750424-5440155L10
SEICENTO						
SEICENTO all model	Unique Single	03/98 ->	703340		2630/1110 x1000	46517955
STILO						
STILO all model	G/L	09/01 ->	703495	803495	1780/1590	51702642-46819335
	D/R	09/01 ->	703496		1640/1450	46819336
STRADA PICK UP						
STRADA PICK UP all model	G/L	02->	NEW 554934		1710/1448	51918394-46471702
	D/R	02->	NEW 554935		1710/1448	51918391-46471701
TIPO & TEMPRA						
TIPO, TEMPRA & TEMPRA SW all model	Primaire Front		702240		406	7609367-46410282-92323732
TIPO, TEMPRA & TEMPRA SW 1.1 1.4 1.6 1.7D (freins à tambours/drum brake)	G/L	05/88 -> 02/96	703150	803150	1413/1050	7615327-92323733
	D/R	05/88 -> 02/96	703140		1375/1000	7615326-92323734
TIPO, TEMPRA & TEMPRA SW 1.6 BVA 1.8 sauf/ except 1.6V & 1.9TD (freins à tambours/drum brake)	G/L	05/88 -> 02/96	703170		1445/1050	7615339
	D/R	05/88 -> 02/96	703160		1405/1010	7615338
TIPO, TEMPRA & TEMPRA SW 1,8 & 2.0 16V (freins à disques/disc brake)	G/L	05/88 -> 12/91	Not available		1495/1142	7615343
	G/L	01/92 -> 02/96	703490	803490	1510/1180	7714822-60812546 46401730-46456849
D/R	05/88 -> 02/96	703491	1460/1120		76153342-60812799 46456850-60577826-60806310	

Véhicule Vehicle	Position	Année Year	SEIM P/n	Kit P/n	Longueur Lenght	OE
FIAT						
ULYSSE						
ULYSSE	Primaire Front	07/94 -> 08/02	102440		500/305	1400813180-1487276080 1472957080-474626 4745E9-4745T5
ULYSSE all model (freins à tambours/drum brake)	G/L	07/94 -> 08/02	204060	804050	989/770	1473322080-4745F2-4745G9
	D/R	07/94 -> 08/02	204050		2290/2060	1473321080-4745F3
ULYSSE (freins à disques/disc brake)	G/L	07/94 -> 08/02	204070	804070	1250/1060	1472959080-4745F4
	D/R	07/94 -> 08/02	204080		2200/2070	1472958080-4745F5
ULYSSE all model (avec silencieux AR longitudinal/ with longitudinal rear silencer)	Primaire Front	09/02 -> OPR 10284 (01/05)	102440		500/305	1400813180-1487276080 1472957080-474626 4745E9-4745T5
ULYSSE all model avec silencieux AR longitudinal/ with longitudinal rear silencer (freins à disques/ disc brake)	G/L	09/02 -> OPR 10284 (01/05)	104090	804081	1068/840	1487274080-4745T6
	D/R	09/02 -> OPR 10284 (01/05)	104080		2360/2220	1487275080-1487647080 4745T8-4745T7
ULYSSE all model (avec silencieux AR longitudinal & transversal/with longitudinal & transversal rear silencer)	Primaire Front	02/05 -> OPR 11682	NEW 555212			474623-1400950680
ULYSSE all model (avec/with silencieux AR longitudinal & transversal)	Primaire Front	OPR 11683->	NEW 554905			474652-1401441780
ULYSSE all model avec silencieux AR longitudinal/ with longitudinal rear silencer (freins à disques/ disc brake)	G/L	02/05 -> 12/06	554050	805021	1041/840	1400310380-4745Y8-474619
	D/R	02/05 -> 12/06	554051		2308/2151	1400310180-4745Y6 4745Y7-1400310280
ULYSSE all model 2.0 MJTD 120 & 136cv avec silencieux AR transversal/with transversal rear silencer (freins à disques/disc brake)	G/L or D/R	01/06 ->	554108	805037	1257/1115	1400204180-474609
UNO						
UNO all model sauf/except Turbo ie	G/L	05/83 -> 10/89	703010		310/530	5951339
	D/R	05/83 -> 10/89	703020		310/2050	5951342
UNO all model sauf/except Turbo ie	G/L	10/89 -> 04/90	703011		530/310	7661241
	G/L	05/90 -> 10/95	703130	803130	530/310	7671310
D/R	10/89 -> 10/95	703120	2020/310		7671309	
UNO Turbo ie			Not available			

FORD						
B MAX						
B MAX 1.0-1.4-1.6-1.5TDCI 75cv & 1.6 TDCI 95cv	Primaire Front	06/12->	NEW 554936		408	1751871-AP312853AB-1534504 8V512853AA
B MAX 1.0-1.4-1.6-1.5TDCI 75cv & 1.6 TDCI 95cv	Unique Single	06/12->	554699		1363/1199+ 1327/1168	1781445-BV512A603AL 1708220-8V512A603AK 1544245-8V512A603AJ
B MAX 1.0-1.4-1.6-1.5TDCI 75cv & 1.6 TDCI 95cv	Liaison G/L or D/R	06/12->	554700		162	1757739-AP312A635AD 1514201-8V512A635AB 1753622
C MAX						
C-MAX all model	Primaire Front	09/03 -> 02/07	NEW 554938		341	1676740-3M512853CC 1420259-3M512853CB
C-MAX all model sans frein automatique/without automatic brake (freins à disques/disc brake)	Unique Single	09/03 -> 02/07	554110		1830/1700+ 1873/1745	1416442
C-MAX all model	Primaire Front	03/07 ->	NEW 554938		341	1676740-3M512853CC 1420259-3M512853CB
C-MAX all model sans frein automatique/without automatic brake (freins à disques/disc brake)	Unique Single	03/07 ->	554111		1816/1700+ 1860/1745	1525804-1707757 3M512A603FC-1490515 1323904-3M512A603FB 3M512A603AF

Véhicule Vehicle	Position	Année Year	SEIM P/n	Kit P/n	Longueur Lenght	OE
FORD Suite...						
C MAX (suite)						
C-MAX II & GRAND C-MAX II TREND 1.6 Ti-VCT105 & 125cv-1.6TDCI 95 & 115cv-2.0TDCI 115-140cv	Primaire Front	09/10->	NEW 554938		341	1676740-3M512853CC 1420259-3M512853CB
C-MAX II & GRAND C-MAX II TITANIUM 1.6 Ti-VCT105 & 125cv-1.6 SCTi 150ch- 1.6TDCI 95 & 115cv-2.0TDCI 115-140 & 163cv	Primaire Front	09/10->	NEW 554937		293	1694256-AV612853AA
COURRIER (FIESTA)						
FIESTA COURRIER II & III	Primaire Front	03/89-> 12/95	603294		151	6502746-1656491
FIESTA COURRIER II & III	Unique Single	03/89-> 12/95	603170		3920X1740 +1680	6723389
FIESTA COURRIER IV	Primaire Front	12/95-> 09/02	602240		312	1004542-1079068-1131657 1151332-1310482
FIESTA COURRIER IV	Unique Single	12/95-> 09/02	603200		1930/1740 +1875/1693	1107631-1014214
ESCORT & ORION						
ESCORT & ORION all model	Primaire Front	80-> 84	Not available		158	6094082
ESCORT & ORION all model	Primaire Front	84-> 11/89	Not available		155	16119118
ESCORT & ORION all model	G/L	80-> 04/84	Not available		1578/1300	60927346130715
	G/L	04/84-> 08/84	Not available		1567/1273	6139442
	D/R	80-> 08/84	Not available		1318/1150	61307146137663-6081825
ESCORT XR3 i	G/L	80-> 84	Not available		1590/1293	1613311
	D/R	80-> 84	Not available		1340/1155	1613310-83AB2A604AA
ESCORT cabriolet/convertible & ORION 1.6i	G/L	80-> 84	Not available		1584/1265	6131134
	D/R	80-> 84	Not available		1330/1135	6131133
ESCORT & ORION 1.1 1.3	Unique Single	84-> 85	603000		2945/1258 +1143	6148022-6158711
ESCORT & ORION 1.1 1.3 & 1.6D	Unique Single	85-> 86	603010		2942/1275 +1140	6141433
ESCORT & ORION 1.6	Unique Single	84-> 85	Not available		2984/1264 +1128	6148023
ESCORT & ORION 1.6	Unique Single	85-> 86	Not available		2968/1265+ 1130	6141434
ESCORT & ORION 1.4 & 1.6D	Unique Single	86-> 09/90	603020		2945/1265 +1140	6161952-6168200
ESCORT & ORION 1.6i	Unique Single	86-> 09/90	Not available		2965/1250 +1130	6161953-6168201
ESCORT & ORION all model	Primaire Front	12/89->	603294		151	6502746-1656491
ESCORT & ORION all model	Unique Single	09/90-> 05/91	603030		1600/1315+ 1630/1380	1664643-1664872
ESCORT IV XR3 i	Unique Single	10/90-> 09/92	603251		1705/1510 +1670/1475	1036199-7402912 1010349-1036199
ESCORT & ORION all model	Unique Single	05/91-> 08/92	Not available		3273/1311 +1400	6676122/3-6912221-1664975
ESCORT RS	Unique Single	91->	Not available		3150/1268 +1387	6676125
ESCORT COSWORTH	Unique Single	92->	Not available		3220/1026 +923	7009327
ESCORT & ORION 1.4i 1.6i & 1.8i	Unique Single	09/92->12/93	Not available		3330/1375 +1310	1664703
ESCORT & ORION all model	Unique Single	01/94-> 01/95	Not available		3273/1311 +1400	6920298-6637334

Véhicule Vehicle	Position	Année Year	SEIM P/n	Kit P/n	Longueur Length	OE
FORD						
						<i>Suite...</i>
ESCORT & ORION (suite)						
ESCORT all model	Primaire Front	01/95 -> 11/95	Not available		281	1002209
ESCORT V 1.4i 1.6i 1.8D & 1.8TD 70 & 90 cv (freins à tambours/drum brake)	Unique Single	01/95 -> 08/00	603251		1705/1510 +1670/1475	1036199-7402912-1010349
ESCORT V 4x4 all model	Unique Single	01/95 ->	Not available		2x1465/1641	7402918-1036208
ESCORT all model	Primaire Front	12/95 ->	Not available		281	1064455-1027516
ESCORT 1.8i mot ZETEC & 2.0i 16v 130 cv (freins à disques/disc brake)	Unique Single	06/96 ->	603252		1604/1437 +1640/1472	1036203-95AB2A603FE
ESCORT fourgonnette	Unique Single	80 -> 90	603130		3178/1342 +1252	6148024-1644435-6092885
ESCORT fourgonnette	Unique Single	09/90 -> 08/91	603250		1673/1458+ 1695/1379	6600956
ESCORT fourgonnette	Unique Single	09/91 -> 06/95	Not available		3400/1460 +1380	6676124-6785736
ESCORT fourgonnette	Unique Single	06/95 ->	603253		1751/1549 +1733/1527	1010352-1036230 7402914-10103511036229
FIESTA I, II & III						
FIESTA all model	Primaire Front	06/76 -> 06/83	Not available		630	6094081-6054814
FIESTA all model	G/L	06/76 -> 06/83	600050	800050	1248	6056822-6040610
	D/R	06/76 -> 06/83	600070		492/424	6056818-6040602
FIESTA II all model	Primaire Front	07/83 -> 02/89	600210		155	1619118-6094082
FIESTA II all model	Unique Single	07/83 -> 02/89	603040		2775/1150 +1130	1627591-6169520 6163735-6148322-6159054
FIESTA III all model	Primaire Front	03/89 -> 10/96	603294		151	6502746-1656491
FIESTA III 1.1 1.3 1.4 1.6 XR2 & Turbo	Unique Single	03/89 -> 01/94	603050		3268/1400 +1346	1659647-1659671
FIESTA III 1.8D & TD	Unique Single	06/89 -> 06/91	603050		3268/1400 +1346	1659647-1659671
FIESTA III 1.8D & TD	Unique Single	07/91 -> 01/94	603150		3260/1400 +1350	6658751
FIESTA III all model	Unique Single	01/94 -> 10/96	603160		3260/1330 +1380	7127225
FIESTA IV & V						
FIESTA IV all model	Primaire Front	09/95 -> 04/02	602240		312	1310482-1004542-1079068 1131657-1151332
FIESTA IV all model	Unique Single	09/95 -> 04/02	554123		1633/1445+ 1582/1387	1306275-1095564-1077296 1312641-1018642 1035693-1042338
FIESTA V 1.0-1.3-1.4-1.6-2.0 ST-1.4 TDCI & 1.6TDCI	Primaire Front	05/02 -> 10/08	600181		300	1205735
FIESTA V 1.0-1.3-1.4-1.6-2.0 ST-1.4 TDCI & 1.6TDCI (freins à tambours/drum brake)	Intermediate	05/02 -> 10/08	603293		1445/1257+ 1305/1115	1502612-1211024 1445646-D35044400C
FIESTA VTT (freins à tambours/drum brake)	Liaison G/L or D/R	05/02 -> 10/08	603230		175	1209852-1232018 98AG2A635AF-1094178 104280-1226733-1220462 1253162-D35044430D
FIESTA V 2.0 ST 150cv (freins à disques/disc brake)	Unique Single	05/02 -> 10/08	Not available		1600/1440 +1750/1580	1445972-1359528
FIESTA VI						
FIESTA VI all model	Primaire Front	09/08 -> 11/12	NEW 554936		408	1534504-8V512853AA 1751871-AP312853AB

Véhicule Vehicle	Position	Année Year	SEIM P/n	Kit P/n	Longueur Length	OE
FORD Suite...						
FIESTA VI (suite)						
FIESTA VI 1.25i-1.4i-1.6i-1.4TDCI & 1.6 TDCI (freins à tambours/drum brake)	Unique Single	09/08 >11/12	554699		1363/1199+ 1327/1168	1544245-8V512A603AJ 1708220-8V512A603AK 1781445-BV512A603AL
FIESTA VI 1.25i-1.4i-1.6i-1.4TDCI & 1.6 TDCI (freins à tambours/drum brake)	Liaison G/L or D/R	09/08 >11/12	554700		162	1514201-8V512A635AB 1753622-1757739 8V512A635AD-1718302
FIESTA VI 1.0i-1.2i-1.6i-1.6i Turbo 182cv SF 1.5 TDCI-1.6 TDCI	Primaire Front	11/12>	NEW 554936		408	1751871-AP312853AB 1534504-8V512853AA
FIESTA VI 1.0i-1.2i-1.6i-1.5 TDCI-1.6 TDCI (freins à tambours/drum brake)	Unique Single	11/12>05/13	554699		1363/1199+ 1327/1168	1781445-BV512A603AL 1708220-8V512A603AK 1544245-8V512A603AJ
FIESTA VI 1.0i-1.2i-1.6i-1.5 TDCI-1.6 TDCI (freins à tambours/drum brake)	Unique Single	06/13>	NEW 555154		1363/1199+ 1327/1169	1831613-8V512A603AN
FIESTA VI 1.0i-1.2i-1.6i-1.5 TDCI-1.6 TDCI (freins à tambours/drum brake)	Liaison G/L or D/R	11/12>	Not available			1797579
FIESTA VI 1.6i Turbo 182ch ST (freins à disques/disc brake)	Unique Single	11/12>	NEW 555155		1630/1445 +1562/1412	1838140-C1BC2A603AE 1818953-C1BC2A603AD
FOCUS I						
FOCUS & FOCUS SW all model	Primaire Front	10/98 > 15/09/01	602000		326	1076707-1073151 YS4Z2853AA
FOCUS & FOCUS SW 1.4i-1.6i-1.8 TDDI 75 & 90cv (freins à tambours/drum brake)	Intermediate	10/98 > 15/09/01	603220		1480/1480+ 1320	1088017-1097285 1069081-YS4Z2A603AB
FOCUS & FOCUS SW 1.4i-1.6i-1.8 TDDI 75 & 90cv (freins à tambours/drum brake)	Liaison G/L or D/R	10/98 > 15/09/01	603230		175	1343668-1064280-1094178 1220462-1226733 1253162-1209852
FOCUS & FOCUS SW 1.8i-2.0i-1.8TDCI 100 & 115cv (freins à disques/disc brake)	Unique Single	10/98 > 15/09/01	603210		2x1770/ 1590	1101841-1069082 1088016-1087208
FOCUS & FOCUS SW all model	Primaire Front	15/09/01 > 09/04	554112		332	1228027
FOCUS & FOCUS SW 1.4i-1.6i-1.8 TDDI 75 & 90cv (freins à tambours/drum brake)	Intermediate	15/09/01 > 09/04	603232		2x1480/ 1320	1253158
FOCUS & FOCUS SW 1.4i-1.6i-1.8 TDDI 75 & 90cv (freins à tambours/drum brake)	Liaison G/L or D/R	15/09/01 > 09/04	603230			1343668-1064280-1094178 1751220462-1226733 1253162-1209852
FOCUS & FOCUS SW 1.8i-2.0i-1.8TDCI 100 & 115cv (freins à disques/disc brake)	Unique Single	15/09/01 > 09/04	603231		2x1770/ 1590	1253159-1143926
FOCUS II						
FOCUS II all model	Primaire Front	10/04 > 11/05	554113		337	1321246
FOCUS II all model (freins à tambours/drum brake)	Intermediate	10/04 > 08/05	554114		1450/1338+ 1500/1388	1366384-1431308
FOCUS II all model (freins à tambours/drum brake)	Liaison G/L or D/R	10/04 > 08/05	603298		228	1340832
FOCUS II all model	Primaire Front	09/05 > 12/07 01/08 >12/10	NEW 554938		341	1676740-3M512853CC 1420259-3M512853CB
FOCUS II 1.4i-1.6i-1.8i-1.6 TDCI 90 & 110cv (freins à tambours/drum brake)	Intermediate	09/05 > 12/07 01/08 >12/10	554117		1490/1388+ 1440/1340	1707756-3M512A603EC 1525803-3M512A603EB 1492822-3M512A603EA
FOCUS II 1.4i-1.6i-1.8i-1.6 TDCI 90 & 110cv (freins à tambours/drum brake)	Liaison G/L or D/R	09/05 > 12/07 01/08 >12/10	554118		225	1525806-3M512A635BB 1492823-3M512A635BA
FOCUS II 2.0i-1.8 TDCI 115cv-2.0TDCI 110 & 136cv (freins à disques/disc brake)	Unique Single	09/05 > 12/07 01/08 >12/10	554111		1816/1700+ 1860/1745	1525804-1490515-1323904 3M512A603FB-3M512A603AF 1707757-3M512A603FC
FOCUS II RS (freins à disques/disc brake)	Unique Single	01/09 >	554119		1940/1803+ 1850/1715	1540884-1501658 8V412A603AD

Véhicule Vehicle	Position	Année Year	SEIM P/n	Kit P/n	Longueur Lenght	OE
FORD Suite...						
FOCUS II (suite)						
FOCUS II cabriolet/convertible 1.6i-2.0i & 2.0TDCI	Primaire Front	10/06 ->	NEW 554938		341	1676740-3M512853CC 1420259-3M512853CB
FOCUS II cabriolet/convertible 1.6i-2.0i & 2.0TDCI	Unique Single	10/06 ->	554111		1816/1700+ 1860/1745	1525804-1490515-1323904 3M512A603FB-3M512A603AF 1707757-3M512A603FC
FOCUS III						
FOCUS III all model	Primaire Front	04/11 ->	NEW 554939		306	1711523-BV612853AA
FOCUS III 1.6 THVCT 85cv & 1.6TDCI 95cv (freins à tambours/drum brake)	Unique Single	04/11 ->	Not available		1546/1436+ 1463/1356	1756206-BV612A603AH 1728853-17368414-1740056 BV612A603AG
FOCUS III & FOCUS III SW 1.0SCT-1.6i-1.6SCT-1.6THVCT 100 & 125cv-2.0SF-1.6TDCI 105 & 115cv-2.0TDCI 115-140 & 163cv (freins à disques/disc brake)	Unique Single	04/11 ->	NEW 555203		1940/1827+ 1870/1748	1755767- AV612A603BJ 1740058-AV612A603BH
FOCUS III & FOCUS III SW 1.0SCT-1.6i-1.6SCT-1.6THVCT-2.0SF-1.6TDCI 105 & 115cv-2.0TDCI 115-140 & 163cv (freins à disques/disc brake)	Liaison G/L or D/R	04/11 ->	NEW 554940		230	1688323-BV612A635AA
FUSION						
FUSION all model	Primaire Front	09/02 ->	600181		300	1205735
FUSION all model	Intermediate	09/02 ->	603293		1445/1257+ 1305/1115	1211024-1445646-1502612
FUSION all model (freins à tambours/drum brake)	Liaison G/L or D/R	09/02 ->	603230		175	1343668-1094178-1220462 1064280-1226733-1253162 1209852-1232018 98AG2A635AF
GALAXY						
GALAXY all model y compris/include 4X4	Intermediate	09/95 -> 03/06	652151		653	1013482-7M0711472A 7M3711472
GALAXY all model y compris/include 4X4	G/L or D/R	09/95 -> 03/06	553180	853180	1230/1130	7201624-7M3609701C 7M0609701B-95VW2A603AC
GALAXY all model	G/L	06/06 -> 08/07	554120	805038	2070/1860	1439905-6G912A635EE
	D/R	06/06 -> 08/07	554121		2067/1854	1439906-6G912B700EE
GALAXY II all model	G/L	08/07 ->	554701	805128	2078/1867	1510211-6G912A635EG 1468846-1706434 6G912A635EH
	D/R	08/07 ->	554702		2071/1855	1545340-6G912B700EG 1711718-6G912B700EH
KA						
KA all model	Primaire Front	10/96 -> 11/06	602240		312	1004542-1079068-1131657 1151332-1310482
KA all model	Unique Single	05/99 -> 12/06	554123		1633/1445+ 1582/1387	1306275-1095564-1077296 1312641-1018642 1035693-1042338
KA all model	Primaire Front	12/06 ->	554124		333	1527247
KA all model sauf/except 1.6	Unique Single	12/06 -> 09/08	554703		1627/1448+ 1575/1398	1479552-5S512A603BA
KA all model 1.6	Unique Single	12/06 -> 09/08	554125		1527/1448+ 1575/1388	1479551
KA II all model	G/L	10/08 ->	554126	805039	1402/1155	1541339-9S512A603BA
	D/R	10/08 ->	554127		1430/1182	1541338-9S512A603AA
KUGA						
KUGA all model	Primaire Front	05/08 ->	554128		360	1517528

Véhicule Vehicle	Position	Année Year	SEIM P/n	Kit P/n	Longueur Lenght	OE
FORD						
KUGA (suite)						
KUGA all model	Unique Single	05/08 ->	554119		1940/1803+ 1850/1715	1540884-1501658 8V412A603AD
KUGA II						
KUGA II 1.6i 150cv & 2.0 TDCI 140 & 163cv	Unique Single	09/12->	NEW 555161		2020/1900+ 1925/1805	1805451-CV612A603BC
MAVERICK						
MAVERICK 2.4 2.7TD 2.7TDI 3 portes/doors	G/L	02/93 -> 10/98	713300	813300	1325 /1115	365310F001-1961868-1954196
	D/R	02/93 -> 10/98	713301		1355/1150	365300F001-1961866-1954194
MAVERICK 2.4 2.7TD 2.7TDI 5 portes/doors	G/L	02/93 -> 10/98	713302	813303	1470/1255	365310F601- 1961869-1954197
	D/R	02/93 -> 10/98	713303		1480/1270	365300F601-1961867-1954195
MONDEO						
MONDEO I all model	Primaire Front	01/93 -> 09/00	603242		270	7264793-6750550
MONDEO I all model sauf/except 2.0i 4x4 2.5 V6 & MONDEO I SW (break) (freins à tambours/drum brake)	G/L or D/R	01/93 -> 07/94	603090	803090	1575/1331	6924890-6854704 F5RZ2A635A
MONDEO I SW (break) all model (freins à tambours/drum brake)	G/L or D/R	01/93 -> 07/94	603120	803120	1593/1388	6854705
MONDEO I & MONDEO I SW (break) all model sauf/except 2.0i 4X4 2.5-V6 (freins à tambours/drum brake)	G/L or D/R	08/94 -> 09/00	603262	803262	1620/1330	1103617-1078044-1005567 1060213-1046069-1078043 1093543-1005568-1019239 1046070- F5RZ2A635C
MONDEO I 2.0i 4x4 & 2.5 V6 sauf/ except MONDEO I SW (break) (freins à disques/disc brake)	G/L or D/R	01/93 -> 07/94	603100	803100	1422/1213	6944442-1007172
MONDEO I 2.0i 4x4 & 2.5 V6 sauf/ except MONDEO I SW (break) (freins à disques/disc brake)	G/L or D/R	08/94 -> 09/00	603263	803263	1462/1212	1050100-1038834-1060214 1093544-1103618 98BG2A809BD
MONDEO I SW (break) all model (freins à disques/disc brake)	G/L or D/R	03/96 -> 09/00	603266		1647/1387	7043631-1108004-1040768 1005574-1019240-1040745 1077950-98BG2A809DB
MONDEO II						
MONDEO II all model	Primaire Front	09/00 -> 05/07	554130		305	1221413-1349905-1121869 1220590-1ST12A603AE 1ST12A603AF
MONDEO II all model sauf/except break (freins à disques/disc brake)	G/L or D/R	09/00 -> 06/07	603297	803297	1760/1530	1221742-1116840-1126842 1332884-1358881 1447430-1S712A809AG
MONDEO II SW (break) all model	G/L or D/R	09/00 -> 06/07	603233	805041	1480/1320	1220591-1116841-1117106 1126843-1130446-1208432 1447432-1358882
MONDEO II & MONDEO II SW (break) all model	Primaire Front	09/00 -> 05/07	554130		305	1349905
MONDEO II all model sauf/except break	G/L or D/R	09/00 -> 06/07	603297	803297	1735/1532	1447430
MONDEO II SW all model (Break)	G/L or D/R	09/00 -> 06/07	603233	805041	1722/1514	1447432
MONDEO III						
MONDEO III & MONDEO SW (break) all model	G/L	06/07 -> 09/10 ->	554701	805128	2078/1867	1510211-6G912A635EG 1468846-1706434 6G912A635EH
	D/R	06/07 -> 09/10 ->	554702		2071/1855	1545340-6G912B700EG 1711718-6G912B700EH
PUMA						
PUMA all model	Primaire Front	06/97 -> 09/02	602240		312	1004542-1079068-1131657 1151332-1310482

Véhicule Vehicle	Position	Année Year	SEIM P/n	Kit P/n	Longueur Lenght	OE
FORD						
<i>Suite...</i>						
PUMA (suite)						
PUMA all model	Unique Single	06/97 -> 09/02	554123		1633/1445+ 1582/1387	1306275-1095564-1077296 1312641-1018642-1035693 1042338
RANGER PICK UP						
RANGER PICK UP 2WD all model	G/L	05/06 ->	NEW 554942		2640/2340	5025630-6M342A823BB UR5844420A
	D/R	05/06 ->	NEW 554943		1823/153	5025625-6M342A604BB UR5844410
RANGER PICK UP 4WD all model	G/L	05/06 ->	NEW 554944		2567/2267	1466819-5025616 6M342A823AB
	D/R	05/06 ->	NEW 554945		1751/1460	1466809-5025608 6M342A604AB
RANGER PICK UP 4WD all model	G/L	05/06 ->	NEW 554946		3102/2800	5025664-6M342A823CB UR6144420- UR6144420A
	D/R	05/06 ->	NEW 554947		2267/1977	5025649-6M342A604CB UR6144410UR6144410A
SCORPIO						
SCORPIO all model	Unique Single	07/85 -> 04/91	600290		3725/1030+ 930	6154286-6168203 6194542-6676649 6779443-85GB2A603AE
SIERRA						
SIERRA all model	Unique Single	09/82 -> 89	600180		3331/975 +869	6120901-6139438-1644433
SIERRA all model sans/without ABS (freins à tambours/drum brake)	Unique Single	89 ->	603269		3320/970 +870	6194541
SIERRA all model avec/with ABS (freins à disques/disc brake)	Unique Single	84 ->	603270		3380/1030+ 920	1656793
S-MAX						
S-MAX all model	G/L	04/06 -> 08/07	554120		2070/1860	1439905-6G912A635EE
	D/R	04/06 -> 08/07	554121		2067/1854	1439906-6G912B700EE
S-MAX all model	G/L	08/07 ->	554701		2078/1867	1510211-6G912A635EG 1468846-1706434- 6G912A635EH
	D/R	08/07 ->	554702		2071/1855	1469021-1545340- 6G912B700EG-1711718- 6G912B700EH
TRANSIT						
TRANSIT 80 120	Unique Single	11/85 -> 09/91	603070		2968/2X 1017+232	6166967
TRANSIT 100L roues jumelées/double wheels	Unique Single	11/85 -> 09/91	554133		2865/2X966 +234	6166969-86VB2A604CE
TRANSIT 130 190A	Unique Single	11/85 -> 09/91	603080		2386/2X773 +234	6166968-86VB2A604BE
TRANSIT all model sauf roues jumelées/ except double wheels	Unique Single	10/91 -> 02/00	603281		2820/2X970 +230	6658706-92VR2853AD
TRANSIT all model roues jumelées/ double wheels/double wheels	Unique Single	10/91 -> 02/00	603282		2730/2X940 +231	6658707-92VR2853CD
TRANSIT III						
TRANSIT III all model	Primaire Front	08/00->09/06	554134		1052/632	4041448-YC152853BD
TRANSIT III chassis court 240-260-280-300	Intermediate	08/00->09/06	NEW 555158		718	4044011-1C152A793DA
TRANSIT III chassis moyen 240-260-280-300	Intermediate	08/00->09/06	NEW 555159		1084	4041989-1C152A793EA
TRANSIT III chassis long 240-260-280-300	Intermediate	08/00->09/06	NEW 555160		1531	4041990-1C152A793FA
TRANSIT III 240-260-280-300 2.0TD 75-85-100-125cv Traction AV/Front wheel drive sauf chassis cabine./except chassis cabs	G/L	08/00->09/06	554136		1547/1257	1494642-4095181-4400344 4519422-1C152A809CF 1C152A809CG

Véhicule Vehicle	Position	Année Year	SEIM P/n	Kit P/n	Longueur Lenght	OE
FORD						
<i>Suite...</i>						
TRANSIT III (suite)						
TRANSIT III 240-260-280-300 2.0TD 75-85-100-125cv Traction AV/Front wheel drive sauf chassis cabine/except chassis cabs	D/R	03/00 -> 12/02	554137		1263/971	4379596-4095179
	D/R	01/03->09/06	554138		1283/987	1494893-1C152A635CE 4519421-1C52A635CD 4639309-YC152A635CH
TRANSIT III 240-260-280-300 2.0TD 75-85-100cv chassis cabine avec traction AV/ chassis cabs with front wheel drive	G/L	08/00->09/06	603291		1648/1355	4120677-4400343
	D/R	08/00 -> 12/02	603292		1310/1018	4095178-4379597
	D/R	01/03->09/06	554139		1352/1062	4519419-1C152A635AD
TRANSIT III 240-260-280-300 2.3 1.6v 2.4DI 75-90-115-120-125-135cv chassis cabine avec roues jumelées & propulsion AR /chassis cabs with double wheels and rear wheel drive	G/L	03/00 -> 12/02	603283	803283	1528/1235	4331045-YC152A809BH
	D/R	03/00 -> 12/02	603284		1260/967	4077635-4041987-4331042
TRANSIT III all model	Primaire Front	08/00->09/06	554134		1052/632	4041448-YC152853BD
TRANSIT III 330-350 chassis court	Intermediate	08/00->09/06	NEW 555157		718	4060870-YC152A793AE
TRANSIT III 330-350 chassis moyen	Intermediate	08/00->09/06	554704		1083	4060871-4041992
TRANSIT III 330-350 chassis long	Intermediate	08/00->09/06	554705		1534	4060872-4041993
TRANSIT III 330-350 fourgon/van 2.4 TD 75-90-115-120-125 & 135cv avec Propulsion AR/with rear wheel drive	G/L	08/00->09/06	603287	803287	1528/1238	4122075-4334046 YC152A809CG
	D/R	08/00->09/06	603288		1282/993	4041988-4331043 YC152A635CG
TRANSIT III 330-350 2.4 TD 75-90-115-120- 125 & 135cv avec roues simples/with simple wheels avec Propulsion AR/with rear wheel drive	G/L	08/00->09/06	603285	803285	1608/1315	4059363-4331044 YC152A809AG
	D/R	08/00->09/06	603286		1386/1093	4041986-4331041 YC152A635AF
TRANSIT III 330-350 2.4 TD 75-90-115-120- 125 & 135cv avec propulsion AR & roues jumelées/with double wheels and rear wheel drive	G/L	08/00->09/06	554717		1587/1297	4469261-4457993 YC152A809BK
	D/R	08/00->09/06	554135		1332/1040	4654291-4457990 YC152A635BJ
TRANSIT IV						
TRANSIT IV all model except KOMBI	Primaire Front	09/06->	554706		1284/1034	1441586-1441582 6C112853BD-1382309 1388274-1388816-1419538 1441586-6C112853AC
TRANSIT IV KOMBI all model	Primaire Front	09/06->	554707		1919/1677	5032100-7C1V2853DB
TRANSIT IV 280-300-330 2.2 TDCi 85- 110 & 130cv Traction AV/Front wheel drive (freins à tambours/drum brake)	G/L	09/06->	554136		1547/1257	1494642-4095181-4400344 4519422-1C152A809CF 1C152A809CG
	D/R	09/06->	554138		1283/987	1494893-1C152A635CE 4519421-1C52A635CD 4639309-YC152A635CH
TRANSIT IV 280-300-330 2.2 TDCi 85-110 & 130cv Propulsion AR/Rear wheel drive (freins à disques/disc brake)	G/L	09/06->15/08/11	554708		1532/1332	1388279-6C112A809AB
	G/L	15/08/11->	554708		1532/1332	1734692-1371467-1388279 6C112A809AB-6C112A809AC 1734688-1371461-1388275
	D/R	09/06->	554709		1265/1067	1441579-1552037 6C112A635AD-6C112A635AE
TRANSIT IV 350 2.2 TDCi 110-130cv 2.4 TDCi 100-115cv Propulsion AR/ Rear wheel drive (freins à disques/disc brake)	Primaire Front	09/06->	554706		1284/1034	1441586-1441582-6C112853BD- 1382309-1388274-1388816 1419538-1441586-6C112853AC
	G/L	09/06->15/08/11	554708		1532/1332	1388279-6C112A809AB
	G/L	15/08/11->	554708		1532/1332	1734692-1371467-1388279 6C112A809AB-6C112A809AC 1734688-1371461-1388275
	D/R	09/06->	554709		1265/1067	1441579-1552037 6C112A635AD-6C112A635AE

Véhicule Vehicle	Position	Année Year	SEIM P/n	Kit P/n	Longueur Lenght	OE
FORD						
<i>Suite...</i>						
TRANSIT IV (suite)						
TRANSIT IV 350 extra long 2.4 TDCi 100-115-140ch Propulsion AR/Rear wheel drive sauf roues jumelées/except double wheels (freins à disques/disc brake)	Primaire Front	09/06->	554706		1284/1034	1441586-1441582-6C112853BD- 1382309-1388274-1388816 1419538-1441586-6C112853AC
	G/L	09/06->15/08/11	554708		1532/1332	1388279-6C112A809AB
	G/L	15/08/11->	554708		1532/1332	1734692-1371467-1388279 6C112A809AB-6C112A809AC
	D/R	09-2006->	554709		1265/1067	1734688-1371461-1388275 1441579-1552037 6C112A635AD-6C112A635AE
TRANSIT IV 350-430 2.4 TDCi 100-115-140ch extra long Propulsion AR/Rear wheel drive avec roues jumelées /with double wheels (freins à disques/disc brake)	Primaire Front	09/06->	554706		1284/1034	1441586-1441582 6C112853BD-1382309 1388274-1388816-1419538 1441586-6C112853AC
	G/L	09/06->	554710		1506/1308	1734695-1388282 6C112A809DB
	D/R	09/06->	554711		1235/1033	1734691-1388278 6C112A635DB-6C112A635DC
TRANSIT IV 460 all model avec propulsion AR/ with rear wheel drive	Primaire Front	09/06->	554706		1284/1034	1441586-1441582-6C112853BD- 1382309-1388274-1388816- 1419538-1441586-6C112853AC
	G/L	09/06->	554713		1343/1120	1488315-1518021 8C1V2A809DB
	D/R	09/06->	554714		994/769	1488313-1552043 8C1V2A635DC
TRANSIT IV chassis cabine avec traction AV/ chassis cabs with front wheel drive (freins à tambours/drum brake)	Primaire Front	09/06->	554706		1284/1034	1441586-1441582-6C112853BD- 1382309-1388274-1388816 1419538-1441586-6C112853AC
	G/L	09/06->	554724		1650/1353	1494895-1C152A809AF
	D/R	09/06->	554725		1354/1058	1494890-1C152A635AE-AD
TRANSIT IV série 2.3 all model chassis cabine/ chassis cabs avec propulsion AR/ with rear wheel drive	Primaire Front	09/06->	554706		1284/1034	1441586-1441582-6C112853BD 1382309-1388274-1388816-
	G/L	09/06->	554720		1337/1115	1419538-1441586 6C112853AC-1488314 1518020-8C1V2A809BB
	D/R	09/06->	554721		1028/805	1488312-1518017 8C1V2A635BB
TRANSIT IV 300 330 350 & 430 Chassis cabine avec propulsion AR & roues simples/chassis cabs with simple rear wheels and rear wheel drive (freins à disques/disc brake)	Primaire Front	09/06->	554706		1284/1034	1441586-1441582-6C112853BD 1382309-1388274-1388816 - 1419538-1441586-6C112853AC
	G/L	09/06->	554715		1602/1398	1388281-1441581 6C112A809CC
	D/R	09/06->	554716		1317/1111	1388277-6C112A635CB
TRANSIT IV 300 330 350 & 430 chassis cabine avec propulsion AR & roues jumelées/ chassis cabs with double wheels and rear wheel drive	Primaire Front	09/06->	554706		1284/1034	1441586-1441582-6C112853BD- 1382309-1388274-1388816 1419538-1441586-6C112853AC
	G/L	09/06->07/09	554718		1533/1335	1388280-1441580 6C112A809BC
	D/R	09/06->07/09	554719		1270/1070	1388276-6C112A635BB
TRANSIT CONNECT						
TRANSIT CONNECT all model	Primaire Front	09/02	NEW 554948		290	5041276-2T142853AA
TRANSIT CONNECT all model court/ short wheelbase sans/without ABS (freins à tambours/drum brake)	Unique Single	09/02->	603238		1780/1580 x2	4539856-4419300-4439339 2T142A603AG

Véhicule Vehicle	Position	Année Year	SEIM P/n	Kit P/n	Longueur Lenght	OE
FORD Suite...						
TRANSIT CONNECT (suite)						
TRANSIT CONNECT all model court/short wheelbase avec/with ABS (freins à disques/disc brake)	Unique Single	09/02 ->	603237		1810/1680 x2	4539859-4439345-4407359 4367116-4388054 4419302-4480912
TRANSIT CONNECT all model long/long wheelbase sans/without ABS (freins à tambours/drum brake)	Unique Single	09/02 ->	603236		1970/1770 x2	4539858-4439343 4419301-2T142A603BG
TRANSIT CONNECT all model long all model avec/with ABS (freins à disques/disc brake)	Unique Single	09/02 ->	603235		1980/1850x2	4439347-4480913-1005357 4105357-4367117-4388055 4407360-4419303 2T142A603DG
TRANSIT CONNECT	Primaire Front	08 ->	NEW 555156		248	4987625-9T162853AA
TRANSIT CONNECT	Unique Single	08 ->	NEW 554950		1977/1777+ 1977/1777	1475243-1516244 7T162A603BB
TRANSIT CONNECT	Unique Single	08 ->	NEW 554951		1818/1694+ 1818/1690	5030150-5135369 7T162A603CD
TRANSIT CONNECT	Unique Single	08 ->	NEW 554952		1984/1860+ 1984/1860	5030151-5135370 7T162A603DD
TRANSIT CONNECT	Unique Single	08 ->	NEW 554949		1784/1588 x2	1516240-5030119 5135368-7T162A603AD

HONDA						
ACCORD						
ACCORD all model (freins à disques/disc brake)	G/L	09/93 -> 09/98	731318		1870/1632	47560SN7953-GVC902371
	D/R	09/93 -> 09/98	731319		1870/1632	47510SN7952-GVC902372
ACCORD all model COUPE	G/L	05/94 -> 09/97	554140		1970/1736	47560SV1950-47560SV1951
	D/R	05/94 -> 09/97	554141		1970/1736	47510SV1950-47510SV1951
ACCORD all model sauf/except 2.0TD	G/L	10/98 -> 01/03	554142		1721/1495	47560S1AE04
	D/R	10/98 -> 01/03	554143		1736/1510	47510S1AE04
ACCORD 2.0TD	G/L or D/R	10/98 -> 01/03	554142		1721/1495	47560S1AE04
CIVIC						
CIVIC IV all model (freins à tambours/drum brake)	G/L	11/91 -> 04/96	731304		1480/1305	47560SR3N01
	D/R	11/91 -> 04/96	731305		1480/1315	47510SR3N01
CIVIC IV all model (freins à disques/disc brake)	G/L	11/91 -> 04/96	731306		1615/1445	47560SR3931-47560SR3933
	D/R	11/91 -> 04/96	731307		1620/1440	47510SR3931-47510SR3933
CIVIC V 3 portes/doors 1.4iS 1.5iS LS 1.6iES	G/L	11/95 -> 04/98	554144		1535/1352	47560SR4A03
	D/R	11/95 -> 04/98	554145		1540/1357	47510SR4A01
CIVIC V 4 portes/doors 1.5iS LS	G/L	11/95 -> 04/98	554144		1535/1352	47560SR4A03
	D/R	11/95 -> 04/98	554145		1540/1357	47510SR4A01
CIVIC IV & V 5 portes/doors avec/with ABS 1.4i & 1.4iS	G/L	01/95 -> 04/01	731312		1630/1450	47560ST3E12-47521SR2933 47560ST3E11-47560ST3E13 47560ST3E51
	D/R	01/95 -> 04/01	731313		1655/1470	47510ST3E11-47510ST3E51 47520SR2933
CIVIC IV & V 3, 4 & 5 portes/doors 1.6i EsI & Vti (freins à disques/disc brake)	G/L	01/95 -> 04/01	NEW 554953		1670/1480	47560S04932-47560S04013 47560SR4934
	D/R	01/95 -> 04/01	NEW 554954		1670/1480	47510S04932-47510S04013 47510SR4933
CIVIC VI 3 portes/doors (freins à tambours/drum brake)	G/L	09/01->12/03	NEW 555166		1947/1755	47560S6AG54
	D/R	09/01->12/03	NEW 555167		1963/1764	47510S6AG53
CIVIC VI 1.7 CDTI	G/L	09/01->12/03	NEW 555170		1947/1755	47560S6AG01
	D/R	09/01->12/03	NEW 555171		1963/1764	47510S6AG01
CIVIC VII 4 portes/doors 1.4 HYBRID	G/L	03/06>11/11	NEW 555168		2148/1894	47560SNA54-47560SNA52
	D/R	03/06>11/11	NEW 555169		2100/1848	47510SNA54-47510SNA52

Véhicule Vehicle	Position	Année Year	SEIM P/n	Kit P/n	Longueur Length	OE
HONDA						
<i>Suite...</i>						
CR-V						
CR-V 2.0i	G/L	05/97 -> 10/02	NEW 554957		1678/1477	47560S10A03
	D/R	05/97 -> 10/02	NEW 554958		1717/1515	47510S10A03
CR-V 2.0 16V	G/L	05/97 -> 10/02	NEW 554955		1717/1515	47560S10E01
	D/R	05/97 -> 10/02	NEW 554956		1694/1491	47510S10E01
HR-V						
HR-V 3 portes/doors	G/L	02/99 -> 06	554554		1480/1225	47560S2H013
	D/R	02/99 -> 06	554555		1425/1167	47510S2H013
HR-V 5 portes/doors	G/L	02/99 -> 06	NEW 554959		1558/1297	47560S4N013
	D/R	02/99 -> 06	NEW 554960		1515/1255	47510S4N013
JAZZ						
JAZZ (freins à tambours/drum brake)	G/L	01/02->11/08	NEW 555164		1593/1366	47560SAA033-47560SAA023 47560SAA043
	D/R	01/02->11/08	NEW 555165		1653/1427	47510SAA023-47510SAA033 47510SAA043
JAZZ (freins à disques/disc brake)	G/L	01/02->11/08	NEW 555162		1634/1443	47560SAAJ54-47560SAAJ53
	D/R	01/02->11/08	NEW 555163		1695/1504	47510SAAJ54-47510SAAJ53

HYUNDAI						
ACCENT						
ACCENT all model	G/L	> 10/95	732305		1505/1335	5976022000
	D/R	> 10/95	732306		1506/1332	5977022000
ACCENT all model	G/L	11/95 -> 11/02	732307		1485/1320	5976022100-5976022110 5976025000
	D/R	11/95 -> 11/02	732308		1485/1318	5977022100-5977022110 5977025000
ACCENT Hatchback all model	G/L	12/02 -> 03/06	554146		1493/1295	5976025200
	D/R	12/02 -> 03/06	554147		1493/1295	5977025200
ACCENT 1.4 all model	G/L	04/06 ->	554148		1588/1318	597601G300
	D/R	04/06 ->	554149		1588/1318	597701G300
ATOS & ATOS PRIME						
ATOS & ATOS PRIME 1.0 & 1.1	G/L	03/98 ->	732309		1504/1318	5976002010-5976002020
	D/R	> Ch. n°980901	732310		1522/1335	5977002010
ATOS & ATOS PRIME 1.0 & 1.1	D/R	Ch. n°980901 ->	732311		1520/1332	5977002020
COUPE						
COUPE all model (freins à tambours/drum brake)	G/L	94 -> 02/02	554150		1520/1305	5976027001
	D/R	94 -> 02/02	554151		1512/1295	5977027001
COUPE all model (freins à disques/disc brake)	G/L	94 -> 02/02	554152		1377/1199	5976027300-5976027301
	D/R	94 -> 02/02	554153		1370/1192	5977027300-5977027301
COUPE II all model (freins à disques avec machoir/disc brake with drum)	G/L	03/02 -> 10/04	554154		1430/1281	597602C300
	D/R	03/02 -> 10/04	554155		1430/1297	597702C300
COUPE II all model avec/with ABS (freins à disques/disc brake)	G/L	03/02 -> 10/04	554156		1425/1280	597602C320
	D/R	03/02 -> 10/04	554157		1425/1280	597702C320
COUPE II all model sans/without ABS (freins à disques/disc brake)	G/L	03/02 -> 10/04	NEW 554961		1441/1280	597602C310
	D/R	03/02 -> 10/04	NEW 554962		1438/1280	597702C310
ELANTRA						
ELANTRA 1.6 all model	G/L	10/00 -> 07/06	554158		1601/1416	597602D310
	D/R	10/00 -> 07/06	554159		1587/1402	597702D310
ELANTRA 2.0 CRDI all model (freins à disques/disc brake)	G/L	10/00 -> 10/03	554158		1601/1416	597602D310
	D/R	10/00 -> 10/03	554159		1587/1402	597702D310
ELANTRA 2.0 CRDI all model (freins à disques/disc brake)	G/L	10/03 -> 09/04	554735		1590/1408	597602D340
	D/R	10/03 -> 09/04	554736		1575/1395	597702D340
ELANTRA 2.0 CRDI all model (freins à disques/disc brake)	G/L	09/04 -> 07/06	554737		1578/1410	597602D350
	D/R	09/04 -> 07/06	554738		1562/1391	597702D350

Véhicule Vehicle	Position	Année Year	SEIM P/n	Kit P/n	Longueur Lenght	OE
HYUNDAI						
GETZ						
GETZ all model 3 portes/doors (freins à tambours/drum brake)	G/L	10/02 ->	554160		1597/1357	597601C800
	D/R	10/02 ->	554161		1610/1368	597701C800
GETZ all model 5 portes/doors (freins à tambours/drum brake)	G/L	10/02 ->	554162		1610/1363	597601C300
	D/R	10/02 ->	554163		1620/1373	597701C300
GETZ all model CRDI (freins à disques/disc brake)	G/L	10/02 ->	554164		1590/1362	597601C000
	D/R	10/02 ->	554165		1600/1375	597701C000
I10						
I10 1.1i-1.2i-1.1 CRDI (freins à disques/disc brake)	G/L	03/08->12/10	NEW 555172		1252/1110	597600X300
	D/R	03/08->12/10	NEW 555173		1263/1117	597700X300
I20						
I20 all model (freins à tambours/drum brake)	G/L	01/09 ->	554166		1615/1363	597601J000-597601J300
	D/R	01/09 ->	554167		1648/1395	597701J000-597701J300
I30						
I30 all model	G/L	07/07 -> 10/08	NEW 554963		1672/1464	597602H300
	D/R	07/07 -> 10/08	NEW 554964		1674/1466	597702H300
I30 all model	G/L	10/08 -> 12/10 07/10 -> 05/12	554168		1715/1518	597602R300-597602L300
	D/R	10/08 -> 12/10 07/10 -> 05/12	554169		1705/1505	597702R300-597702L300
IX 35						
IX 35 2WD 1.6 GDH-1.7CRDI-2.0CRDI	G/L	09/10->	NEW 555176		1726/1468	597603S200-597603W200
	D/R	09/10->	NEW 555177		1724/1460	597703S200-597703W200
IX 35 4WD 1.6 GDH-1.7CRDI-2.0CRDI	G/L	09/10->	Not available		1726/1468	597602Y500
	D/R	09/10->	Not available		1724/1460	597702Y500
LANTRA						
LANTRA all model		> 09/95	Not available			
LANTRA all model (freins à tambours/drum brake)	G/L	10/95 ->	554170		1578/1362	5976029001
	D/R	10/95 ->	554171		1571/1357	5977029001
LANTRA all model (freins à disques/disc brake)	G/L	10/95 ->	554172		1436/1260	5976029301
	D/R	10/95 ->	554173		1428/1250	5977029301
MATRIX						
MATRIX 1,6 i & 1,8 i	G/L	09/01 -> 05	554174		1650/1405	5976017010
	D/R	09/01 -> 05	554175		1718/1475	5977017010
MATRIX 1,5 CRDI	G/L	05 ->	554176		1718/1475	5976017510
	D/R	05 ->	554177		1650/1405	5977017510
SANTA FE						
SANTA FE all model (freins à tambours/drum brake)	G/L	09/00 -> 02/06	554178		1741/1526	5991226150
	D/R	09/00 -> 02/06	554179		1776/1561	5991326150
SANTA FE II all model (avec commande de frein à levier with brake control lever)	G/L	01/06 -> 12/10	NEW 554967		1878/1650	597602B000
	D/R	01/06 -> 12/10	NEW 554968		1812/1584	597702B000
SANTA FE II all model (avec commande de frein à pédale/with brake control pedal)	G/L	01/06 -> 12/10	NEW 554965		1674/1470	597602B500
	D/R	01/06 -> 12/10	NEW 554966		1962/1756	597702B550
SONATA						
SONATA all model (freins à disques/disc brake)	G/L	95 ->	554180		1829/1643	5976034101-5976034102
	D/R	95 ->	554181		1827/1643	5977034102
TUCSON						
TUCSON 2.0 CRDI 112-140 & 149cv	G/L	09/04->10/10	NEW 555174		1785/1575	597602E500
	D/R	09/04->10/10	NEW 555175		1875/1665	597702E500
IVECO						
DAILY						
DAILY (29L) C12C18-S14 freins à disques/ disc brake (simple essieux/simple wheel)	G/L or D/R	99 -> 06	554745		1318/960	500322988

Véhicule Vehicle	Position	Année Year	SEIM P/n	Kit P/n	Longueur Lenght	OE
IVECO Suite...						
DAILY (suite)						
DAILY (29L-35-40) C12-C18-S14 (freins à tambours/drum brake)	G/L or D/R	06 ->	554746		1318/980	504347504
DAILY 29L-30/35C all model simple essieux/ simple wheel (freins à disques/disc brake)	G/L or D/R	06 ->	NEW 554973		1414/1060	504201383-504347501
NEW DAILY 35.8-35.10 & 49.12 empattement/ wheelbase 2800	Primaire Front	96 ->	554739		1135/775	93812314
NEW DAILY 35.8-35.10 & 49.12 empattement/ wheelbase 3310	Primaire Front	96 ->	554740		1645/880	93812315
NEW DAILY 35.8-35.10 & 49.12 empattement/ wheelbase 3600	Primaire Front	96 ->	554741		1930/880	93812316
NEW DAILY 35.8-35.10 & 49.12 empattement/ wheelbase 3600	Primaire Front	96 ->	554742		1853/930	93815550
NEW DAILY 35.8-35.10 & 49.12 empattement/ wheelbase 3950	Primaire Front	96 ->	554743		2210/1345	93821392
NEW DAILY 35.8-35.10-35.12 & 49.12 (freins à tambour/drum brake)	Unique Single	96 ->	554744		2674/985x2	99434589
DAILY 35.12 (freins à tambour/drum brake)	Unique Single	96 -> 99	NEW 554974			99461607
DAILY 35C all model avec roues jumelées/ with double wheels (freins à disques/disc brake)	G/L or D/R	06 ->	NEW 554975		1266/920	504347502
DAILY 35C10-C12-C15 avec roues jumelées/ with double wheels (freins à disques/disc brake)	G/L or D/R	06 ->	554188		1210/866	504201378
DAILY 50C13 50C15 BUS (freins à tambours/drum brake)	G/L or D/R	00 ->	554187		1315/981	504003617
DAILY Turbo 59.12 empattement/ wheelbase 3310	Primaire Front	96 ->	554182		1520/920	93812534
DAILY Turbo 59.12 empattement/ wheelbase 3600	Primaire Front	96 ->	554183		1810/920	93812535
DAILY Turbo 59.12 empattement/ wheelbase 3950	Primaire Front	96 ->	554184		2160/1340	93812536
DAILY Turbo 59.12 empattement/ wheelbase 4180	Primaire Front	96 ->	554185		2360/1560	93812537
DAILY Turbo 59.12	Unique Single	96 ->	554186		2915/2x1010	93812499

ISUZU						
FASTER PICKUP						
FASTER PICKUP 2WD all model	G/L	07/99 ->	NEW 554969		1812/1640	522523-97217149
	D/R	07/99 ->	NEW 554970		1872/1700	522520-97174665
FASTER PICKUP 4WD all model	G/L	07/99 ->	NEW 554971		1798/1630	522429-97111566
	D/R	07/99 ->	NEW 554972		1858/1700	522428-97111565

JEEP						
CHEROKEE						
CHEROKEE all model	Primaire Front	04/97 -> 01	NEW 554985		737/589	52128164-52128164AB
CHEROKEE all model	G/L	04/97 -> 01	NEW 554986		894/687	52128073
	D/R	04/97 -> 01	NEW 554987		1815/1606	52128072AB
CHEROKEE all model	G/L	01 -> 12/06	NEW 554979			52128511AD-AF
	D/R	01 -> 12/06	NEW 554980			52128510AE-AG
CHEROKEE LIBERTY all model	G/L	01 -> 12/06	NEW 554981			52128257AE
	D/R	01 -> 12/06	NEW 554982			52128256AE

Véhicule Vehicle	Position	Année Year	SEIM P/n	Kit P/n	Longueur Lenght	OE
JEEP Suite...						
GRAND CHEROKEE						
GRAND CHEROKEE II 2.7 CRD	Primaire Front	00 -> 12/04	NEW 554976		872/618	52128243AD 52128243AA-52128243AC
GRAND CHEROKEE II 2.7 CRD	G/L	00 -> 12/04	NEW 554977		1104/983	52128119AC 52128119AE-52128119AH
	D/R	00 -> 12/04	NEW 554978		1128/1007	52128118AC 52128118AF-52128118AH
GRAND CHEROKEE II 3.0 CRD	G/L	00 -> 12/04	NEW 554977		1104/983	52128119AC 52128119AE-52128119AH
	D/R	00 -> 12/04	NEW 554978		1128/1007	52128118AC-52128118AF 52128118AH
GRAND CHEROKEE III 3.0 CRD	Primaire Front	12/04>12/10	NEW 554983		801/543	5134701AB
GRAND CHEROKEE IV	Primaire Front	12/10->	NEW 554984		770/542	68065503AA
KIA						
CARENS						
CARENS all model (freins à tambours/drum brake)	G/L	11/01 -> 07/02	554190		1622/1357	OK2C044420
	D/R	11/01 -> 07/02	554191		1628/1363	OK2C044410
CARENS II all model	Primaire Front	07/02 -> 12/06	554189		270	OK2FA44150
CARENS I & II 1.8 1.6v & 2.0 CRDI (freins à disques/disc brake)	G/L	11/01 ->	554192		1670/1405	OK2A244420E-OK2A244420D
	D/R	11/01 -> 01/05	554193		1658/1389	OK2A244410F-OK2A244410E
	D/R	01/05 ->12/06	NEW 554988		1652/1393	OK2FX44410
CARNIVAL						
CARNIVAL all model	Primaire Front	99 -> 01	554194		1750/1447	OK55244150G
CARNIVAL all model	Primaire Front	02 -> 03	554195		1644/1450	OK56B44150
CEE'D						
CEE'D & CEE'D SPORTWAGON (break) all model	G/L	01/07 -> 05/12	554747		1670/1475	597601H400
	D/R	01/07 -> 05/12	554748		1675/1478	597701H400
CERATO						
CERATO 1.6i-1.5 & 2.0 CRDI	G/L	03/04 -> 11/04	554196		1576/1404	597602F100
	D/R	03/04 -> 11/04	554197		1560/1386	597702F100
CERATO 1.6i-1.5 & 2.0 CRDI	G/L	11/04 ->	NEW 554989		1576/1404	597602F200
	D/R	11/04 ->	554197		1560/1386	597702F200
PICANTO						
PICANTO all model sans/without ABS	G/L	06/04 -> 12/07	554749		1488/1252	5976007010
	D/R	06/04 -> 12/07	554750		1488/1252	5977007010
PICANTO all model avec/with ABS	G/L	03/04 -> 01/05	NEW 554990		1518/1300	5976007300
	D/R	03/04 -> 01/05	NEW 554991		1520/1300	5977007300
PICANTO all model avec/with ABS	G/L	01/05 -> 12/07	554198		1515/1306	5976007310
	D/R	01/05 -> 12/07	554199		1515/1306	5977007310
PICANTO 1.0 62cv & 1.1i 65cv (freins à tambours/drum brake)	G/L	01/08 -> 03/11	554749		1488/1252	5976007410
	D/R	01/08 -> 03/11	554750		1488/1252	5977007410
PICANTO 1.1CRDI all model	G/L	01/08 -> 03/11	554198		1515/1306	5976007310
	D/R	01/08 -> 03/11	554199		1515/1306	5977007310
RIO						
RIO all model 1.3 LS & 1.5 LS	G/L	06/01 -> 09/05	554200		1584/1390	OK30A44420H
	D/R	06/01 -> 09/05	554201		1584/1390	OK30A44410H
RIO all model 1.4 1.6 & 1.5 CRDI	G/L	09/05 -> 11/09	554148		1588/1318	597601G300
	D/R	09/05 -> 11/09	554149		1588/1318	597701G300

Véhicule Vehicle	Position	Année Year	SEIM P/n	Kit P/n	Longueur Lenght	OE
KIA Suite...						
SEPHIA						
SEPHIA all model avec/with ABS	G/L	07/08 -> 10/00	554192		1670/1405	OK2A244420E-OK2A244420D
	D/R		554193		1658/1389	OK2A244410F-OK2A244410E
SHUMA						
SHUMA all model (freins à tambours/drum brake)	G/L	11/00 ->	554190		1622/1357	OK2C044420
	D/R	11/00 ->	554191		1628/1363	OK2C044410
SHUMA all model (freins à disques/disc brake)	G/L	11/00 ->	554192		1670/1405	OK2A244420D
	D/R	11/00 ->	554193		1658/1389	OK2A244410E-OK2A244410F
SPORTAGE						
SPORTAGE	Primaire Front	10/94 ->09/02	554202		335	OK01144150D-OK01144150G
SPORTAGE I	G/L	03/99 ->09/02	554204		1492/1212	OK04544420B
	D/R	03/99 ->09/02	554203		1588/1311	OK04544410D
SPORTAGE II	Primaire Front		Not available			597501F000
	G/L	09/04->09/10	Not available			597601F200
	D/R	09/04->09/10	Not available			597701F200
SPORTAGE III 2WD 1.6 GDI-1.7CRDI-2.0CRDI	G/L	09/10->	NEW 555176		1726/1468	597603W200-597603S200
	D/R	09/10->	NEW 555177		1724/1460	597703W200-597703S200
SPORTAGE III 4WD 1.6 GDI-1.7CRDI-2.0CRDI	G/L	09/10->	Not available		1726/1468	597602Y500
	D/R	09/10->	Not available		1724/1460	597702Y500
LADA						
SAMARA & SAGONA						
SAMARA / SAGONA 2101 & 2105	G/L or D/R	86 ->	763040		1617/1370	21083508180
2101 2105 all model	Primaire Front	70 ->87	Not available		470	21013508068
2101 2105 all model	Unique Single	70 ->87	763010		2510/865x2	21013508180
NIVA						
NIVA	Primaire Front	76 ->	Not available		380	21213508068
NIVA	Unique Single	76 ->	763030		2130/775x2	21213508180
LANCIA						
DELTA						
DELTA III all model sauf/except 1.8 TJET 200cv	G/L	07/08 ->	554206		1902/1700	51808306
	D/R	07/08 ->	554207		1760/1567	51808304
DELTA III 1.8 TJET 200cv	G/L	07/08 ->	NEW 554992		1942/1748	51826008
	D/R	07/08 ->	NEW 554993		1792/1613	51826007
KAPPA						
KAPPA all model	Primaire Front	12/94 ->	554753		311	82488247
KAPPA all model	G/L	12/94 ->	554208		1345/1221	82488246-60629718
	D/R	12/94 ->	554209		1298/1175	82488245-60629717
LYBRA						
LYBRA all model	Primaire Front	09/99 ->	702250		390	7773616
LYBRA all model	G/L	09/99 ->	554210		1266/945	46546714
	D/R	09/99 ->	554211		1222/901	46546713
MUSA						
MUSA 1.4-1.4 GPL-1.4 16v & 1.3 MJTD (70cv)	G/L or D/R	09/04 -> 10/07	703463		1535/1295	51731443-51770286
MUSA 1.3MJTD (90cv) & 1.9 MJTD	G/L or D/R	09/04 -> 10/07	703462		1557/1295	46847434-51770287

Véhicule Vehicle	Position	Année Year	SEIM P/n	Kit P/n	Longueur Length	OE
LANCIA						
MUSA (suite)						
MUSA 1.6MJTD	G/L or D/R	10/07 ->	554101		1618/1423	51804860
PHEDRA						
PHEDRA all model avec silencieux AR longitudinal/with longitudinal rear silencer	Primaire Front	09/02 ->OPR 10284 (01/05)	102440		500/305	1400813180-1487276080 1472957080-474626-4745E9 4745T5
PHEDRA all model avec silencieux AR longitudinal/with longitudinal rear silencer (freins à disques/disc brake) -> OPR 10284	G/L	09/02 ->OPR 10284 (01/05)	104090	804081	1068/840	1487274080-4745T6
	D/R	09/02 ->OPR 10284 (01/05)	104080		2360/2220	1487275080-1487647080 4745T8-4745T7-
PHEDRA all model avec silencieux AR longitudinal & transversal/with longitudinal & transversal rear silencer	Primaire Front	02/05 ->OPR 11682 (11/08)	NEW 555212			474623-1400950680
PHEDRA all model avec silencieux AR longitudinal & transversal/with longitudinal & transversal rear silencer	Primaire Front	OPR 11683 (11/08)->	NEW 554905			474652-1401441780
PHEDRA all model avec silencieux AR longitudinal/with longitudinal rear silencer (freins à disques/disc brake) OPR 10285->	G/L	02/05 -> 12/06	554050	805021	1041/840	1400310380-4745Y8-474619
	D/R	02/05 -> 12/06	554051		2308/2151	1400310180-4745Y6 4745Y7-1400310280
PHEDRA 2.0MJTD 120 & 136cv avec silencieux AR transversal/with transversal rear silencer (freins à disques/disc brake)	G/L or D/R	01/06 ->	554108	805037	1257/1115	1400204180-474609
PRISMA						
PRISMA			Not available			
THEMA						
THEMA	Unique Single	05/86->09/96	703110		2950/1235x 1375	82390671-82441688 60801383-60801449 60801790-60801823
THEMA II	Primaire Front	11/11 ->	NEW 555199		3145/3016	K04779589AE-4779589AE
THEMA II	G/L	11/11 ->	NEW 555200		752/607	K68066189AC-68066189AC
	D/R	11/11 ->	NEW 555201		718/574	K04779592AC-4779592AC
Y-Y10 & YPSILON						
Y10 all model	Unique Single	03/85 -> 92	Not available			
Y10 4x4	Unique Single	03/85 -> 92	703000		2690/2x1000	4406021
Y10 sauf/except 4x4	Unique Single	10/92 -> 12/96	703497		2380x940x 952	7757560
Y10 4x4	Unique Single	10/92 -> 12/96	703000		2690/2x 1000	4406021
Y/ YPSILON III	G/L	01/96 -> 09/00	703499	803498	1392/1228	82487780
	D/R	01/96 -> 09/00	703498		1414/1250	82487709
YPSILON IV (843) all model	G/L or D/R	10/03 -> 06/11	554213		1425/1190	51776180-46813948
YPSILON V (846) all model	G/L	06/11 ->	NEW 554994		1535/1258	51900231
	D/R	06/11 ->	NEW 554995		1535/1258	51900232
ZETA						
ZETA all model	Primaire Front	95 -> 02	102440		500/305	1400813180-1487276080 1472957080-474626-4745E9 4745T5
ZETA all model (freins à tambours/drum brake)	G/L	95 -> 02	204060	804050	989/770	1473322080-4745F2-4745G9
	D/R	95 -> 02	204050		2290/2060	1473321080-4745F3
ZETA all model (freins à disques/disc brake)	G/L	95 -> 02	204070	804070	1250/1060	1472959080-4745F4
	D/R	95 -> 02	204080		2200/2070	1472958080-4745F5

Véhicule Vehicle	Position	Année Year	SEIM P/n	Kit P/n	Longueur Lenght	OE
LAND ROVER						
DEFENDER						
DEFENDER TD5 3 portes/doors	Unique Single	91 -> Ch. n°LA935629	NEW 554996		1148/936	NRC5089
DEFENDER TD5 3 portes/doors	Unique Single	Ch. n°1A614480 ->	NEW 554997		990/750	SPB500200-SPB000160
DISCOVERY						
DISCOVERY all model	Unique Single	90 -> Ch. n° KA055568	NEW 555000		1194/1012	NTC9400
DISCOVERY all model	Unique Single	Ch. n° KA055569 -> Ch. n° LA081991	NEW 555001		1824/1602	NTC6125
DISCOVERY all model	Unique Single	Ch.n°MA081992 -> 09/98	NEW 555002		815/565	STC1528
DISCOVERY II all model	Unique Single	09/98 -> 07/00	NEW 554999		770/520	SPB101500
DISCOVERY II all model	Unique Single	07/00 -> 09/04	NEW 554998		788/527	SPB000150
FREELANDER						
FREELANDER II all model	G/L	10/01 -> Ch. n°YA999999	653294		1568/1286	SPB101311-SPB101310
	D/R	10/01 -> Ch. n°YA999999	653293		1568/1286	SPB101300
FREELANDER II all model	G/L	Ch.n°1A000001 -> 09/02	554214		1600/1285	SPB000190-SPB101436
	D/R	Ch.n°1A000001 -> 09/02	554215		1600/1285	SPB000180-SPB101426
FREELANDER III all model	G/L	09/02 -> 11/03	653294		1568/1286	SPB101311-SPB101310
	D/R	09/02 -> 11/03	554644		1577/1286	SPB101301
FREELANDER III all model	G/L	11/03 -> 12/06	554214		1600/1285	SPB000190-SPB101436
	D/R	11/03 -> 12/06	554215		1600/1285	SPB000180-SPB101426
FREELANDER V all model	G/L	01/07 ->	NEW 555003		1578/1294	LRO14431-LRO08807-LRO01032
	D/R	01/07 ->	NEW 555004		1573/1292	LRO07496-LRO01031
RANGE ROVER						
RANGE ROVER		-> 02	Not available			
RANGE ROVER II & III all model sauf/ except SPORT	G/L	07/00 -> 05/05	554216		1878/1230	SPB000053
	D/R	07/00 -> 05/05	554217		1846/1200	SPB000043
RANGE ROVER SPORT (freins électriques/electric brake)		05/05 -> 09/09	Not available			LRO19223

MAZDA						
121						
121	Primaire Front	03/96 ->	602240		312	1E0044150-1E044150A
121	Unique Single	03/96 ->	554123		1638/1450+ 1582/1395	1E0044410A
323						
323 all model	Primaire Front	10/85 -> 10/89	Not available			B09244150
323 (BF) all model (freins à tambours/drum brake)	G/L	10/85 -> 10/89	735305		1410/825	B09244420A/B/CD/BF6744420E
	D/R	10/85 -> 10/89	735304		1420/835	B09244410A/B/CD/BF6744410E
323 (BF) all model (freins à disques/disc brake)	G/L	10/85 -> 10/89	554224		1341/754	B10744420E
	D/R	10/85 -> 10/89	554225		1333/754	B10744410E
323 all model WAGON	G/L	10/85 -> 10/89	554226		1420/760	B21644420C/B
	D/R	10/85 -> 10/89	554227		1420/760	B21644410C/B
323 (BG) all model	Primaire Front	11/89 -> 04/95	554228		280	B45544150
323 (BG) all model 3 portes/doors (freins à tambours/drum brake)	G/L	11/89 -> 04/95	735307		1470/1280	B46744420C/D/E
	D/R	11/89 -> 04/95	735308		1500/1330	B46744410C/D/E

Véhicule Vehicle	Position	Année Year	SEIM P/n	Kit P/n	Longueur Lenght	OE
MAZDA						
<i>Suite...</i>						
323 (suite)						
323 (BG) all model 4/ 5 portes/doors sauf/ exept 4VVD (freins à tambours/drum brake)	G/L	11/89 -> 91	Not available		1503/1316	BC45544420C
	D/R	11/89 -> 91	Not available		1466/1265	BC45544410C
323 (BG) all model 4/ 5 portes/doors sauf/ exept 4VVD (freins à tambours/drum brake)	G/L	92 -> 04/95	735309		1505/1325	B45544420D/E
	D/R	92 -> 04/95	735310		1465/1275	B45544410D/E
323 all model (BG) all model 4/ 5 portes/doors sauf/exept 4VVD (freins à disques/disc brake)	G/L	11/89 -> 04/95	554229		1404/1210	B46144420C
	D/R	11/89 -> 04/95	554230		1404/1210	B46144410C
323 (BA) 1.5 3 portes/doors	G/L	05/95 -> 98	554231		1553/1354	BC1B44420A
	D/R	05/95 -> 98	554232		1553/1354	BC1B44410A
323 (BA) all model 4/5 portes/doors	G/L	05/95 -> 98	554233		1653/1450	BC1D44420B-BC1D44420C
	D/R	05/95 -> 98	554234		1653/1450	BC1D44410B
323 (BA) 2.0i	G/L	05/95 -> 98	554235		1516/1312	BC1E44420D
	D/R	05/95 -> 98	554236		1516/1312	BC1E44410C
323 (Bj) all model (freins à tambours/drum brake)	G/L	98 -> 03	554237		1640/1375	B25D44420B-B25D44420C
	D/R	98 -> 03	554238		1660/1394	B25D44410B-B25D44410C
323 (Bj) all model (freins à disques/disc brake)	G/L	98 -> 03	554239		1693/1480	GE7C44420D-GE7C44420B
	D/R	98 -> 03	554240		1715/1500	GE7C44410D-GE7C44410B
626						
626 all model	Primaire Front	09/87 -> 01/92	735313		255	Gj2144150-GA5R44150C
626 all model (freins à tambours/drum brake)	G/L	09/87 -> 01/92	735317		1650/1440	G21744420B/H
	D/R	09/87 -> 01/92	735316		1630/1420	G21744410C/F/G
626 & 626 SW (break) all model (freins à disques/disc brake)	G/L	09/87 -> 01/92	Not available		1700/1535	G21344420F
	D/R	09/87 -> 01/92	Not available		1685/1510	G21344410A/C/E
626 GTI	G/L	09/87 -> 89	Not available		1700/1524	G23844420B
	D/R	09/87 -> 89	Not available		1685/1503	G21344410E-G23844410B
626 COUPE 1.6 & 2.0 (OHC)	G/L	09/87 -> 89	Not available		1586/1373	Gj2144420K
	D/R	09/87 -> 89	Not available		1575/1356	Gj2144410H
626 COUPE 1.6 & 2.0 (DOHC)	G/L	09/89 -> 91	735318		1641/1461	Gj2544420G/H/J
	D/R	09/89 -> 91	735319		1630/1460	Gj2544410D/E/G
626 all model	Primaire Front	01/92 -> 05/97	735313		255	Gj2144150-GA5R44150C
626 (GE) all model (freins à disques/disc brake)	G/L	01/92 -> 05/97	735321		1655/1445	GA5R44420D
	D/R	01/92 -> 05/97	735320		1655/1445	GA5R44410C
626 all model	Primaire Front	06/97 -> 99	735323		405	GD7A44150
626 all model (freins à tambours/drum brake)	G/L	06/97 -> 98	735325		1725/1488	GD7A44420
	D/R	06/97 -> 98	735324		1725/1488	GD7A44410
626 all model (freins à tambours/drum brake)	G/L	98 -> 99	554241		1665/1433	GE4T44420D-GE4T44420B
	D/R	98 -> 99	554242		1685/1453	GET4T44410D-GET4T4441B
626 all model 4/5 portes/doors (freins à disques/disc brake)	G/L	98 -> 99	554239		1693/1480	GE7C44420D-GE7C44420B
	D/R	98 -> 99	554240		1715/1500	GE7C44410D-GE7C44410B
626 all model (freins à disques/disc brake)	G/L	00 -> 02	554245		1764/1555	G14T44420B
	D/R	00 -> 02	554246		1777/1570	G14T44410B
BT50 PICK UP						
BT50 PICK UP 2WD	G/L	05/06 -> 06/08	NEW 554942		2640/2340	UR5844420A 6M342A823BB-5025630
	D/R	05/06 -> 06/08	NEW 554943		1823/1531	UR5844410 6M342A604BB-5025625
BT50 PICK UP 4WD	G/L	05/06 -> 06/08	NEW 554946		3102/2800	UR6144420UR6144420A 6M342A823CB-5025664
	D/R	05/06 -> 06/08	NEW 554947		2267/1977	UR6144410UR6144410A 6M342A604CB-5025649
MAZDA 2						
MAZDA 2 all model	Primaire Front	03/03 -> 04/08	602240		312	D35044430D-1004542-1079068 1131657-1151332-1310482

Véhicule Vehicle	Position	Année Year	SEIM P/n	Kit P/n	Longueur Length	OE
MAZDA						
						<i>Suite...</i>
MAZDA 2 (suite)						
MAZDA 2 all model (freins à tambours/drum brake)	Intermédiaire	03/03 -> 04/08	603293		1445/1257+ 1305/1115	D35044400C 1211024-1445646
MAZDA 2 all model (freins à tambours/drum brake)	Liaison G/L or D/R	03/03 -> 04/08	603230		175	D35044430D-1209852-1232018 98AG2A635AF-1094178-104280 1226733-1220462-1253162
MAZDA 2 II all model	Primaire Front	04/08 ->	NEW 554936		408	D65144150B-1534504 8V512853AA
MAZDA 2 II all model	Unique Single	04/08 ->	NEW 555005		1360/1197+ 1328/1168	D65144400J-D65144400D D65144400H
MAZDA 2 II all model	Liaison G/L or D/R	04/08 ->	554700		162	D65144430A
MAZDA 3						
MAZDA 3 all model	Primaire Front	09/03 ->	554218		345	BP4K44150C
MAZDA 3 all model	G/L	09/03 ->	554219		1831/1700	BP4K44420K-3N612A603BR
	D/R	09/03 ->	554220		1875/1744	BP4K44410L-BP4K44410M 3N612A603BR
MAZDA 5						
MAZDA 5 all model	Primaire Front	06/05 ->	735313		250	GA5R44150C-B
MAZDA 5 all model	G/L	06/05 ->	554221		1828/1700	C23644420E-C23644420D C23644420C
	D/R	06/05 ->	554222		1810/1680	C23644410E-C23644410D C23644410C
MAZDA 6						
MAZDA 6 (GG) all model Phase I & II	Unique Single	04/02 -> 10/08	554223		1645/1432+ 1640/1432	Gj6A44410C-Gj6A44410A G22C44410B-G22C44410C
MAZDA 6 II (GH) all model	Primaire Front	03/08 ->	Not available			GS1D44150B
MAZDA 6 II (GH) all model	Unique Single	03/08 ->	NEW 555006		1654/1467+ 1657/1464	GS1D44410B
MX5						
MX5 all model	G/L	01/98 -> 12/00	554247		1175/1002	NA0144420B
	D/R	01/98 -> 12/00	554248		1175/1002	NA0144410B
MX5 all model	G/L	01/01 -> 10/05	554249		1143/963	NC1044420A-NC1044420B
	D/R	01/01 -> 10/05	554250		1143/963	NC1044410A-NC1044410B
MX6						
MX6 all model	Primaire Front	01/92 -> 05/97	735313		255	Gj2144150-GA5R44150C
MX6 all model (freins à disques/disc brake)	G/L	01/92 -> 05/97	735321		1655/1445	GA5R44420D
	D/R	01/92 -> 05/97	735320		1655/1445	GA5R44410C
PREMACY						
PREMACY all model	Primaire Front	07/99 -> 06/05	735313		255	GA5R44150C-Gj2144150
PREMACY all model (freins à tambours/drum brake)	G/L	07/99 -> 06/05	554251		1730/1503	G14V44420C
	D/R	07/99 -> 06/05	554252		1740/1513	G14V44410C
PREMACY all model (freins à disques/disc brake)	G/L	07/99 -> 06/05	554245		1764/1555	C15344420A-G14T44420B
	D/R	07/99 -> 06/05	554246		1777/1570	C15344410A-G14T44410B
MERCEDES						
190						
190 all model	Primaire Front	06/83 -> 06/93	Not available		538	2014200485
190 (freins à disques/disc brake)	G/L or D/R	06/83 -> 88	352310		1060/808	2014200685-1244201185
190 (freins à disques/disc brake)	G/L or D/R	88 -> 06/93	Not available		1044/800	2014200785

Véhicule Vehicle	Position	Année Year	SEIM P/n	Kit P/n	Longueur Lenght	OE
MERCEDES Suite...						
CLASSE A						
Classe A (168) all model sauf/except Family	Primaire Front	01/98 -> 09/04	554253		987/385	1684201685
Classe A (168) Family all model	Primaire Front	03/01 -> 09/04	554254		1153/665	1684202085
Classe A (168) 140-160-180-160CDI & 170CDI (freins à tambours/drum brake)	G/L	01/98 -> 09/04	352311		1056/503	1684201785
	D/R	01/98 -> 09/04	352300		732/500	1684201585
Classe A (168) 190 & 210 (freins à disques/disc brake)	G/L	01/98 -> 09/04	554256		1038/520	1684201985
	D/R	01/98 -> 09/04	554258		685/520	1684200785
Classe A II (169)	Primaire Front	12/04 -> 06/12	554259		1056/503	1694201785
Classe A II (169) 150-160-170-180-200-160CDI 180CDI & 200CDI (freins à disques/disc brake)	G/L	12/04 -> 06/12	554260	805042	587/476	1694201185
	D/R	12/04 -> 06/12	554261		1215/1065	1694201285
CLASSE B						
Classe B (245) 150-170-180-200-180CDI & 200CDI	Primaire Front	06/05 -> 09/11	554259		1307/1105	1694201885-1694201785 1694200985-1694201685
Classe B (245) 150-170-180-200-180CDI & 200CDI (freins à disques/disc brake)	G/L	06/05 -> 09/11	554260		587/476	1694201185
	D/R	06/05 -> 09/11	554261		1215/1065	1694201285
CLASSE C						
Classe C (W202) 180-200-220-230-280-220D & 250TD	Primaire Front	06/93 -> 05/00	352200		2554/2385	2024201685-2024200885 2024202985
Classe C (W202) 180-200-220-230-280 220D-250TD	G/L	06/93 -> 05/00	352305		965/805	2024202785-2024200185 &2024202285
	D/R	06/93 -> 05/00	352306		925/762	2024202885-2024200285 2024202385
Classe C (W203) 180-200-240-320-200CDI 220CDI & 270CDI	Primaire Front	05/00 -> 06/07	554264		2735/2586	2034200185-2034200985
Classe C (W203) 180-200-240-320-200CDI 220CDI & 270CDI	G/L	05/00 -> 06/07	554265	805043	925/805	2034200285
	D/R	05/00 -> 06/07	554266		900/785	2034200385
Classe C Coupé Sport (CL203) 160-180-200-230-320-200CDI-220CDI	Primaire Front	03/01 -> 04/08	554264		2735/2586	2034200185-2034200985
Classe C Coupé Sport (CL203) 160-180 200-230-320-200CDI-220CDI	G/L	03/01 -> 04/08	554265	805043	925/805	2034200285
	D/R	03/01 -> 04/08	554266		900/785	2034200385
CLASSE C Coupé CLK (C208) all model	Primaire Front	01/98 -> 05/02	554263		2067/1933	2024203385
CLASSE C Coupé CLK (C208) all model	G/L	01/98 -> 05/02	352305		965/805	2024202785-2024200185 2024202285
	D/R	01/98 -> 05/02	352306		925/762	2024202885-2024200285 2024202385
Classe C Coupé & cabriolet/ convertible CLK (209) all model	Primaire Front	05/02 -> 12/09	554264		2735/2586	2034200185-2034200985
Classe C Coupé & cabriolet/ convertible CLK (209) all model	G/L	05/02 -> 12/09	554265	805043	925/805	2034200285
	D/R	05/02 -> 12/09	554266		900/785	2034200385
Classe C (W204) 180-200-250-350-180CDI 200CDI-220CDI-250CDI-300CDI-320CDI & 350CDI	Primaire Front	01/07 -> 01/11 ->	554267		2057/1900	2044201485
Classe C (W204) 180-200-250-350-180CDI 200CDI-220CDI-250CDI-300CDI-320CDI & 350CDI	Intermediate	01/07 -> 01/11 ->	554268		1152/745	2044201085
Classe C (W204) 180-200-250-350-180CDI 200CDI-220CDI-250CDI-300CDI-320CDI & 350CDI	G/L or D/R	01/07 -> 01/11 ->	554269	805044	728/595	2044202585-2044200985
Classe C Coupé & cabriolet/ convertible CLK (C204) all model	Primaire Front	01/11 ->	554267		2057/1900	2044201485
Classe C Coupé & cabriolet/ convertible CLK (C204) all model	Intermediate	01/11 ->	554268		1152/745	2044201085

Véhicule Vehicle	Position	Année Year	SEIM P/n	Kit P/n	Longueur Lenght	OE
MERCEDES Suite...						
CLASSE C (suite)						
Classe C Coupé & cabriolet/convertible CLK (C204) all model	G/L or D/R	01/11 ->	554269	805044	728/595	2044202585-2044200985
CLASSE E						
Classe E (W124) 230CE -300CE-300CE24-320CE-E36 AMG	Primaire Front	02/85 -> 09/95	NEW 555020			A1244202585-1244202585
Classe E (W124) all modell except 230CE -300CE-300CE24-320CE-E36 AMG	Primaire Front	02/85 -> 09/95	NEW 555021		2496/1886	1244202685-1244201085
Classe E (W124) Coupé 230CE-300CE, berline/sedan & break/SW E200-E230-E260-E280-E300-E200D-E250D-E250D Turbo-E300D-E300D Turbo	G/L or D/R	09/93 -> 12/95	352310		1060/808	2014200685-1244201185
Classe E (W210) berline/sedan & break/SW (T210) E200-E240-E280-E320-E420-E430-E200CDI-E220CDI-E220D-E290TD-E300TD	Primaire Front	06/95 -> 12/02	352309		2613/2423	2104201885-2104200885
Classe E (W210) berline/sedan & break/SW (T210) E200-E240-E280-E320-E420-E430-E200CDI-E220CDI-E220D-E290TD-E300TD	G/L	06/95 -> 12/02	352308		1070/830	2104201485-2104201085
	D/R	06/95 -> 12/02	352307		1050/810	2014201585-2104201185
Classe E (W211) berline/sedan & break/SW (T211) E200-E240-E280-E320-E350-E500-E55 AMG-E63 AMG-E200CDI-E220CDI-E270CDI-E280CDI-E320CDI-E420CDI	Primaire Front	03/02 -> 12/08	554270		1950/1810	2114200185-2114201785
Classe E (W211) berline/sedan & break/SW (T211) E200-E240-E280-E320-E350-E500-E55 AMG-E63 AMG-E200CDI-E220CDI-E270CDI-E280CDI-E320CDI-E420CDI	G/L	03/02 -> 12/08	554272	805045	1742/1560	2114202385-2114200285
	D/R	03/02 -> 12/08	554271		1726/1545	2114202485-2114200385
CLASSE E (W212) berline/sedan & break/SW (T212) 200 CGI-250CGI-350CGI-500-AMG 63-200CDI-220CDI-250CDI-350CDI	Primaire Front	03/09 ->	NEW 555022		2040/1890	2124200785
CLASSE E (W212) berline/sedan & break/SW (T212) 200 CGI-250CGI-350CGI-500-AMG 63-200CDI-220CDI-250CDI-350CDI	Intermediate	03/09 ->	NEW 555023		1250/860	2124200285
CLASSE E (W212) berline/sedan & break/SW (T212) 200 CGI-250CGI-350CGI-500-AMG 63-200CDI-220CDI-250CDI-350CDI	G/L or D/R	03/09 ->	554734		743/602	2124200185
CLASSE E (W207) COUPE 250CGI-300CGI-500-250CDI & 300CDI	Primaire Front	05/09 ->	554267		2057/1900	2044201485
CLASSE E (W207) COUPE 250CGI-300CGI-500-250CDI & 300CDI	Intermediate	05/09 ->	554268		1152/745	2044201085
CLASSE E (W207) COUPE 250CGI-300CGI-500-250CDI & 300CDI	G/L or D/R	05/09 ->	554269	805044	728/595	2044200985
CLASSE E (W207) COUPE 250CGI-300CGI-500-250CDI & 300CDI	G/L or D/R	05/09 ->	554734		743/602	2124200185
CLASSE G (W461-W463)						
CLASSE G (W461-W463) all model 5 portes/5 doors (freins à tambours/drum brake Ø 260)	G/L	90 -> 12/00 ->	NEW 554025		2106/1749	4634200585-A4604304254
	D/R	90 -> 12/00 ->	NEW 554024		2255/1900	4634200685-A4604304354
Classe G (W461) G270CDI-G280CDI-G300CDI-290GDT (freins à tambours/drum brake)	G/L	90 -> 12/00 ->	Not available			A4614202185
	D/R	90 -> 12/00 ->	Not available			A4614202285
CLASSE G (W461)	G/L	->Ch.102983 ->Ch.912194	Not available			A4604206685
CLASSE G (W461) Ø 270	D/R	->Ch.102983 ->Ch.912194	Not available			A4604302254

Véhicule Vehicle	Position	Année Year	SEIM P/n	Kit P/n	Longueur Lenght	OE
MERCEDES Suite...						
CLASSE G (W461-W463) (suite)						
CLASSE G (W461) Ø 270	G/L	Ch.102984-> Ch.912195->	Not available			A4604206785
CLASSE G (W461)	D/R	Ch.102984-> Ch.912195->	Not available			A4604207085
Classe G (W461-W463) (freins à disques/disc brake)	G/L	90->	NEW 555040			A4634205185-4634205185
	D/R	90->	NEW 555041			A4634205085-4634205085
CLASSE GL (164)						
CLASSE GL	G/L or D/R	01/06 -> 10/12	554277	805047	817/715	1644202385-1644200385
CLASSE GLK (204)						
CLASSE GLK (204)	Primaire Front	07/08 ->	NEW 554026		2057/1902	2044201585-2044201885
CLASSE GLK (204)	Intermediate	07/08 ->	NEW 554027		1140/746	2044200885
CLASSE GLK (204)	G/L or D/R	07/08 ->	NEW 554028		744/603	2044201785
CLASSE M (163)						
CLASSE ML (163) 230-320-350-430-500-55 AMG-270CDI & 400CDI only left hand drive (direction à gauche)	Primaire Front	01/98 -> 03/05	554274		1780/1600	1634200285
CLASSE ML (163) 230-320-350-430-500-55 AMG-270CDI & 400CDI only right hand drive (direction à droite)	Primaire Front	01/98 -> 03/05	554273		1445/1276	1634200385
CLASSE ML (163) 230-320-350-430-500-55 AMG -270CDI & 400CDI	G/L	01/98 -> 03/05	554275	805046	2025/1868	1634200785-501210310E
	D/R	01/98 -> 03/05	554276		1932/1770	1634200885-501210311C
CLASSE ML (164) 350-450-500-63 AMG- 280CDI-320CDI-420CDI	Primaire Front	Ch. 026669 ->	Not available			1644201985
CLASSE ML (164) 350-450-500-63 AMG- 280CDI-320CDI-420CDI	G/L or D/R	06/05 ->	554277	805047	817/715	1644202385-1644200385
CLASSE R (W251)						
CLASSE R (W251) all model		10/05 ->	NEW 555029		822/722	2514202385
CLASSE S						
CLASSE S all model	Primaire Front	11/98 -> 08/05	554278		2760/227	2204200985
CLASSE S 320 CDI	Primaire Front	11/98 -> 08/05	554279		2937/2282	2204201785
CLASSE S COUPE	Primaire Front	11/98 -> 08/05	554280		2742/2282	2154200485
CLASSE S all model	G/L	11/98 -> 12/99	554281		992/814	2204202785
	D/R	11/98 -> 12/99	554282		978/800	2204202885
CLASSE S all model	G/L	01/00 -> 08/05	554283		1008/824	2204201985
	D/R	01/00 -> 08/05	554284		998/811	2204202085
CLASSE S CL500	G/L	11/98 -> 08/05	554285		995/818	2204202285
	D/R	11/98 -> 08/05	554286		980/808	2204202385
CLASSE SLK						
CLASSE SLK 200 280 350 55 AMG	Primaire Front	03/04 ->	Not available			1714200085
CLASSE SLK 200 280 350 55 AMG	G/L	03/04 ->	554289		760/646	1714200185
	D/R	03/04 ->	554290		1004/780	1714200285
SPRINTER (741)						
SPRINTER Type 741407-741408-741409 HLO avec roues simples/with simple wheel	G/L or D/R	05/95 -> 06/06	554296		1515/1330	A9014201885-9014201885 -2D0609721
SPRINTER Type n° 741.408/04 3,5T avec roues simples/with simple wheels	G/L or D/R	05/95 -> 06/06	554297		1545/1360	A9014202885-9014202885
SPRINTER Type 741 130 HL avec roues simples/ with simple wheel	G/L	05/95 -> 06/06	554298		1565/1390	A9044200585-9044200585
	D/R	05/95 -> 06/06	554299		1565/1390	A9044200685-9044200685

Véhicule Vehicle	Position	Année Year	SEIM P/n	Kit P/n	Longueur Lenght	OE
MERCEDES Suite...						
SPRINTER (741) (suite)						
SPRINTER Type 741130 HL avec roues jumelées/with double wheels	G/L	05/95 -> 06/06	554303		1525/1350	A9044200185-9044200185-2D0609721A
	D/R	05/95 -> 06/06	554304		1525/1350	A9044200285-9044200285-2D0609722
SPRINTER Type 741130 HL	G/L	05/95 -> 06/06	Not available			A9044200785
	D/R	05/95 -> 06/06	Not available			A9044200885
SPRINTER TYPE n° 741131 HL avec roues jumelées/with double wheels	G/L	05/95 -> 06/06	554305		1680/1505	A6674204685-6674204685
	D/R	05/95 -> 06/06	554306		1680/1500	A6674204785-6674204785
SPRINTER (901-902-903)						
SPRINTER (901-902-903) empattement/wheel base 3000 Sauf siege pivotant/without front swivel seat	Primaire Front	05/95 -> 06/06	554293		1435/285	A9014202085-9014202085-2D0609701
SPRINTER (901-902-903) empattement/wheel base 3000 Avec siège pivotant/ with front swivel seat	Primaire Front	05/95 -> 06/06	554300		1415/285	A9014202785
SPRINTER (901-902-903) empattement/wheel base 3550 Sauf siege pivotant/ without front swivel seat	Primaire Front	05/95 -> 06/06	554294		1990/285	A9014202185-9014202185-2D0609701A
SPRINTER (901-902-903) empattement/wheel base 3550 Avec siège pivotant/ with front swivel seat	Primaire Front	05/95 -> 06/06	554301		1970/285	A9044200385-9044200385-2D0609701C
SPRINTER (901-902-903) empattement 3550 Avec siege AV pivotant & frein à main rabattable/with front swivel seat & folding hand brake Camping car Westfalia	Primaire Front	05/95 -> 06/06	NEW 555030			A9014202985-9014202985
SPRINTER (903) empattement/wheel base 4025 Sauf siege pivotant/ without front swivel seat	Primaire Front	05/95 -> 06/06	554295		2460/285	A9014202285-9014202285-2D0609701B
SPRINTER (903) empattement/wheel base 4025 Avec siège pivotant/ with front swivel seat	Primaire Front	05/95 -> 06/06	554302		2440/285	A9044200485-9044200485-2D0609701D
SPRINTER (901-902-903) HLO all model	G/L or D/R	05/95 -> 06/06	554296		1515/1330	A9014201885-9014201885-2D0609721
SPRINTER (903) all model	G/L or D/R	05/95 -> 06/06	554297		1545/1360	A9014202885-9014202885
SPRINTER (904)						
SPRINTER (904) all model empattement/wheel base 3250 sauf châssis cabine/except chassis cabs	Primaire Front	06/06 ->	554307		1468/365	A9064202485-9064202485-9064205085-2E3609701A
SPRINTER (904) empattement/wheel base 3550 Sauf siege pivotant/ without front swivel seat	Primaire Front	06/06 ->	554294		1990/285	A9014202185-9014202185-2D0609701A
SPRINTER (904) empattement/wheel base 3550 Avec siège pivotant/ with front swivel seat	Primaire Front	06/06 ->	554301		1970/285	A9044200385-9044200385-2D0609701C
SPRINTER (904) all model empattement/wheelbase 3665 sauf châssis cabine/except chassis cabs	Primaire Front	06/06 ->	554308		1853/365	A9064202285-9064202285-9064205185-2E0609701L
SPRINTER (904) all model empattement/wheelbase 4325 sauf châssis cabine/except chassis cabs	Primaire Front	06/06 ->	554309		2509/365	A9064202385-9064202385-2E0609701M-9064205285
SPRINTER (904) empattement/wheel base 4025 Sauf siege pivotant/ without front swivel seat	Primaire Front	06/06 ->	554295		2460/285	A9014202285-9014202285-2D0609701B
SPRINTER (904) empattement/wheel base 4025 Avec siège pivotant/ with front swivel seat	Primaire Front	06/06 ->	554302		2440/285	A9044200485-9044200485-2D0609701D
SPRINTER (904) all model empattement/wheel base 3250 châssis cabine/chassis cabs	Primaire Front	06/06 ->	554310		1361/271	A9064202885-9064202885-2E3609701R-9064205385-2E0609701R
SPRINTER (904) all model empattement/wheel base 3665 châssis cabine/chassis cabs	Primaire Front	06/06 ->	554311		1758/271	A9064202685-9064202685-2E0609701P-9064205485

Véhicule Vehicle	Position	Année Year	SEIM P/n	Kit P/n	Longueur Length	OE
MERCEDES Suite...						
SPRINTER (904) (suite)						
SPRINTER all model empattement/ wheel base 4325 châssis cabine/chassis cabs	Primaire Front	06/06 ->	554312		2415/271	A9064202785-9064202785 -2E0609701Q-9064205585- A9064205585
SPRINTER (904) 3.0T 3.2T 3.5 & 4.6T 209CDI-211CDI-213CDI-309CDI-311CDI- 313CDI-409CDI & 411CDI avec/with roues simples	G/L or D/R	06/06 ->	554313		1666/1407	A9064202085-9064202085 -2E0609701J
SPRINTER (904) 5T 215CDI-218CDI- 224-315CDI-318CDI-324-415CDI-418CDI-424- 515CDI-518CDI avec roues simples/ with simple wheels	G/L or D/R	06/06 ->	554732		1392/1061	A9064207085-9064207085 A9064204485-9064204485 A9064203085-9064203085 2E0609702B-2E0609701AR
SPRINTER (904) 5T avec roues jumelées/ with double wheels	G/L or D/R	06/06 ->	NEW 555035			A9064207185-9064207185 A9064204585-A906420318 2E0609701AA-2E0609702C
SPRINTER (906)						
SPRINTER (906) all model empattement/ wheel base 3250	Primaire Front	06/06 ->	554307		1454/365	A9064205085-A9064202485 -2E3609701A
SPRINTER (906) all model empattement/ wheel base 3250 - avec caisson de siege conducteur bas/ with box driver seat bottom - avec siege AV pivotant & frein à main rabattable /with front swivel seat & folding hand brake	Primaire Front	->31/01/11 -> Ch. S 544979	554310		1361/271	A9064202885 9064202885 2E3609701R 9064205385
SPRINTER (906) all model empattement/ wheel base 3250 - avec caisson de siege conducteur bas/ with box driver seat bottom - avec siege AV pivotant & frein à main rabattable /with front swivel seat & folding hand brake	Primaire Front	31/01/11-> Ch. S 544980->	554310			A9064205385 9064205385 A9064202885 9064202885 2E3609701R
SPRINTER (906) all model empattement/ wheel base 3250 - sans caisson de siege conducteur bas / without box driver seat bottom - avec siege AV pivotant & frein à main rabattable/ with front swivel seat & folding hand brake	Primaire Front	->31/01/11 -> Ch. S 544979	NEW 555205			A9064203785
SPRINTER (906) all model empattement/ wheel base 3250 - sans caisson de siege conducteur bas / without box driver seat bottom - avec siege AV pivotant & frein à main rabattable/ with front swivel seat & folding hand brake	Primaire Front	31/01/11-> Ch. S 544980->	NEW 554037			A9064205685
SPRINTER (906) all model empattement/ wheel base 3600 - avec caisson de siege conducteur bas/ with box driver seat bottom - avec siege AV pivotant & frein à main rabattable/ with front swivel seat & folding hand brake	Primaire Front	-> 29/04/11 -> Ch. N 473670	Not available			A9064204685-A9064201785
SPRINTER (906) all model empattement/ wheel base 3600 - avec caisson de siege conducteur bas/ with box driver seat bottom - avec siege AV pivotant & frein à main rabattable/ with front swivel seat & folding hand brake	Primaire Front	29/04/11-> Ch. N 473671->	Not available			A9064206585

Véhicule Vehicle	Position	Année Year	SEIM P/n	Kit P/n	Longueur Lenght	OE
MERCEDES						
SPRINTER (906) (suite)						
SPRINTER (906) all model empattement/ wheel base 3600 - sans caisson de siege conducteur bas / without box driver seat bottom - avec siege AV pivotant & frein à main rabattable/ with front swivel seat & folding hand brake	Primaire Front	06/06 ->	NEW 555148			A9064206285-A9064204085
SPRINTER (906) all model empattement/ wheel base 3600 - sans caisson de siege conducteur bas / without box driver seat bottom - sans siege AV pivotant & frein à main rabattable/ without front swivel seat & folding hand brake	Primaire Front	06/06 ->	Not available			A9064205985-A9064203485
SPRINTER (906) all model empattement/ wheel base 3665 - sans caisson de siege conducteur bas /without box driver seat bottom - sans siege AV pivotant & frein à main rabattable/ without front swivel seat & folding hand brake	Primaire Front	06/06 ->	554308		1853/365	A9064205185-9064205185 A9064202285-9064202285 -2E0609701L
SPRINTER (906) empattement/wheel base 3665 all model - avec caisson de siege conducteur bas/ with box driver seat bottom - avec siege AV pivotant & frein à main rabattable/ with front swivel seat & folding hand brake	Primaire Front	->31/01/11 -> Ch. S 544979	554311		1758/271	A9064202685-9064202685 9064205485-2E0609701
SPRINTER (906) empattement/wheel base 3665 all model - avec caisson de siege conducteur bas/ with box driver seat bottom - avec siege AV pivotant & frein à main rabattable/ with front swivel seat & folding hand brake	Primaire Front	31/01/11-> Ch. S 544980->	554311		1758/271	A9064205485-A9064202685 -906420268-2E0609701
SPRINTER (906) empattement/wheel base 3665 all model - sans caisson de siege conducteur bas / without box driver seat bottom - avec siege AV pivotant & frein à main rabattable/ with front swivel seat & folding hand brake	Primaire Front	->31/01/11 -> Ch. S 544979	NEW 554036			A9064203885-9064203885
SPRINTER (906) all model empattement/ wheel base 3665 - sans caisson de siege conducteur bas / without box driver seat bottom - avec siege AV pivotant & frein à main rabattable/ with front swivel seat & folding hand brake	Primaire Front	31/01/11-> Ch. S 544980->	NEW 555033			A9064205785-9064205785 -A9064203385-9064203385
SPRINTER (906) all model empattement/ wheel base 3850 - avec caisson de siege conducteur bas/ with box driver seat bottom - avec siege AV pivotant & frein à main rabattable/ with front swivel seat & folding hand brake	Primaire Front	-> 25/02/11 -> Ch. N 473670	Not available			A9064204785-A9064201885
SPRINTER (906) all model empattement/ wheel base 3850 - avec caisson de siege conducteur bas/ with box driver seat bottom - avec siege AV pivotant & frein à main rabattable/ with front swivel seat & folding hand brake	Primaire Front	25/02/11-> Ch. N 473671->	Not available			A9064206685

Véhicule Vehicle	Position	Année Year	SEIM P/n	Kit P/n	Longueur Lenght	OE
MERCEDES Suite...						
SPRINTER (906) (suite)						
SPRINTER (906) all model empattement/ wheel base 3850 - sans caisson de siege conducteur bas / without box driver seat bottom - avec siege AV pivotant & frein à main rabattable/ with front swivel seat & folding hand brake	Primaire Front	-> 22/12/10 -> Ch. N 473670	NEW 555206			A9064204185
SPRINTER (906) all model empattement/ wheel base 3850 - sans caisson de siege conducteur bas / without box driver seat bottom - avec siege AV pivotant & frein à main rabattable/ with front swivel seat & folding hand brake	Primaire Front	22/12/10-> Ch. N 473671->	NEW 555034			A9064206385
SPRINTER (906) all model empattement/ wheel base 3850 - sans caisson de siege conducteur bas / without box driver seat bottom - sans siege AV pivotant & frein à main rabattable/ without front swivel seat & folding hand brake	Primaire Front	-> 22/12/10 -> Ch. N 473670	Not available			A9064203585
SPRINTER (906) all model empattement/ wheel base 3850 - sans caisson de siege conducteur bas / without box driver seat bottom - sans siege AV pivotant & frein à main rabattable/ without front swivel seat & folding hand brake	Primaire Front	22/12/10-> Ch. N 473671->	Not available			A9064206085
SPRINTER (906) all model empattement/ wheel base 4100 - avec caisson de siege conducteur bas/ with box driver seat bottom - avec siege AV pivotant & frein à main rabattable/ with front swivel seat & folding hand brake	Primaire Front	-> 10/01/11 -> Ch. N 473670	NEW 555033			A9064204885-A9064203385 9064203385-A9064205785 9064205785-A9064203385
SPRINTER (906) all model empattement/ wheel base 4100 - avec caisson de siege conducteur bas/ with box driver seat bottom - avec siege AV pivotant & frein à main rabattable/ with front swivel seat & folding hand brake	Primaire Front	10/01/11-> Ch. N 473671->	Not available			A9064206785
SPRINTER (906) all model empattement/ wheel base 4100 - sans caisson de siege conducteur bas / without box driver seat bottom - sans siege AV pivotant & frein à main rabattable/ without front swivel seat & folding hand brake	Primaire Front	-> 11/01/11 -> Ch. N 473670	NEW 555207			A9064203685
SPRINTER (906) all model empattement/ wheel base 4100 - sans caisson de siege conducteur bas / without box driver seat bottom - sans siege AV pivotant & frein à main rabattable/ without front swivel seat & folding hand brake	Primaire Front	12/01/11-> Ch. N 473671->	NEW 555147			A9064206185-9064206185
SPRINTER (906) all model empattement/ wheel base 4100 - sans caisson de siege conducteur bas / without box driver seat bottom - avec siege AV pivotant & frein à main rabattable/ with front swivel seat & folding hand brake	Primaire Front	-> 22/12/10 -> Ch. N 473670	NEW 555208			A9064204285

Véhicule Vehicle	Position	Année Year	SEIM P/n	Kit P/n	Longueur Lenght	OE
MERCEDES Suite...						
SPRINTER (906) (suite)						
SPRINTER (906) all model empattement/ wheel base 4100 - sans caisson de siege conducteur bas / without box driver seat bottom - avec siege AV pivotant & frein à main rabattable/ with front swivel seat & folding hand brake	Primaire Front	22/12/10-> Ch. N 473671->	NEW 555149			A9064206485-9064206485
SPRINTER (906) all model empattement/ wheel base 4325	Primaire Front	06/06 ->	554309		2509/365	A9064205285-9064205285 A9064202385-9064202385 2E0609701M
SPRINTER (906) all model empattement/ wheel base 4325 - avec caisson de siege conducteur bas/ with box driver seat bottom - avec siege AV pivotant & frein à main rabattable/ with front swivel seat & folding hand brake	Primaire Front	->31/01/11 -> Ch. N 475424 -> Ch. S 544979	NEW 555209			A9064202785-9064203785
SPRINTER (906) all model empattement/ wheel base 4325 - avec caisson de siege conducteur bas/ with box driver seat bottom - avec siege AV pivotant & frein à main rabattable/ with front swivel seat & folding hand brake	Primaire Front	31/01/11-> Ch. S 544980-> Ch. N 475425->	554312		2415/271	A9064205585-9064205585 A9064205585-9064202785 2E0609701Q
SPRINTER (906) all model empattement/ wheel base 4325 - sans caisson de siege conducteur bas / without box driver seat bottom - avec siege AV pivotant & frein à main rabattable/ with front swivel seat & folding hand brake	Primaire Front	->31/01/11 -> Ch. S 544979 -> Ch. N 475424	NEW 555210			A9064203985
SPRINTER (906) all model empattement/ wheel base 4325 - sans caisson de siege conducteur bas / without box driver seat bottom - avec siege AV pivotant & frein à main rabattable/ with front swivel seat & folding hand brake	Primaire Front	31/01/11-> Ch. S 544980-> Ch. N 475425->	NEW 555032			A9064205885-9064205885
SPRINTER (906) 3T-3T5	G/L or D/R	06/06 ->	NEW 555031			A9064206985-9064202985
SPRINTER (906) 3T & 3T5 Châssis cabine long/ long chassis cabs all model	G/L or D/R	06/06 ->	NEW 555031			A9064206985-A9064202985
SPRINTER (906) 3T & 3T5 Châssis cabine/ Chassis cabs all model	G/L or D/R	->09/04/08 -> Ch. N 376102	NEW 555211			A9064201985
SPRINTER (906) 3T & 3T5 Châssis cabine/ Chassis cabs all model	G/L or D/R	09/04/08-> Ch. N 376103->	Not available			A9064207285-A9064204385
SPRINTER (906) 3T & 3T5 CAMPING CAR	G/L or D/R	06/06 ->	Not available			A9064207385-A9064204985
SPRINTER (906) 5T 524-509 CDI-511 CDI- 515 CDI-518 CDI sauf pneu/except tyre 285/65/R16	G/L or D/R	06/06 ->	554732		1392/1061	A9064207085-9064207085 A9064204485-9064204485 -2E0609702B-2E0609701AR -A9064203085-9064203085
SPRINTER (906) 5T 524-509 CDI-511 CDI- 515 CDI-518 CDI avec pneu/with tyre 2 85/65/R16	G/L or D/R	06/06 ->	NEW 555035			A9064207185-9064207185 A9064204585-A9064203185 2E0609701AA-2E0609702C
SPRINTER (906) NCV3 MINIBUS	Primaire Front	06/06 ->	NEW 555038			A6124200485-6124200485
SPRINTER (906) NCV3 MINIBUS	G/L	06/06 ->	554732		1392/1061	A9064204485-9064204485 A9064207085-9064207085 A9064203085-9064203085 2E0609702B-2E0609701AR
	D/R	06/06 ->	NEW 555039			A6124200585-6124200585

Véhicule Vehicle	Position	Année Year	SEIM P/n	Kit P/n	Longueur Lenght	OE
MERCEDES						
SPRINTER (909)						
SPRINTER (909) empattement/wheel base 4025	Primaire Front		554295		2460/285	A9014202285-9014202285 -2D0609701B
VANEO						
VANEO all model	Primaire Front	03/02 ->	554316		1463/860	4144200185
VANEO 1.6 82cv-1.6 102cv-1.9 CDI 75cv & CDI 91cv	G/L	03/02 ->	554256		1038/520	1684201985
	D/R	03/02 ->	554258		685/520	1684200785
VIANO						
VIANO all model empattement/wheelbase 3200 chassis compact & long/compact & long wheel	Intermediate	10/03 -> 09/10	554319		2432/1370	6394201485
VIANO empattement/wheelbase 3430 all model extra long	Intermediate	10/03 -> 09/10	554326		2799/1733	6394201385
VIANO all model	G/L	10/03 -> 09/10	554321	805057	1285/1035	6394203585-6394270438
	D/R	10/03 -> 09/10	554322		1152/903	6394203685-6394270538
VITO						
VITO (638) all model	Primaire Front	04/96 -> 09/03	NEW 555042		1270/1046	6384200585
VITO (638) all model	Intermediate	04/96 -> 09/03	554291		2925/2715	6384200785
VITO (638) all model	G/L or D/R	04/96 -> 09/03	554292		1170/905	6384270338
VITO (639) all model empattement/ wheelbase 3200	Intermediate	10/03 -> 09/10	554319		2432/1370	6394201485
VITO (639) all model empattement/ wheelbase 3430 sauf/except 4x4	Intermediate	10/03 -> 09/10	554326		2799/1733	6394201385
VITO (639) all model 4X4 empattement/ wheelbase 3430	Intermediate	10/03 -> 09/10	554320		2818/1751	6394201785
VITO (639) all model	G/L	10/03 -> 09/10	554321	805057	1285/1035	6394203585-6394270438
	D/R	10/03 -> 09/10	554322		1152/903	6394203685-6394270538

MG						
MG F						
MG F		98 -> 02	Not available			
MG TF						
MG TF		02 ->	Not available			
MG ZR						
MG ZR all model sans/without ABS (freins à tambours/drum brake)	G/L	01/00 ->	554411		1743/1520	GVC902386-SPB000350
	D/R	01/00 ->	554412		1713/1488	GVC902387-SPB000340
MG ZR all model avec/with ABS (freins à disques/disc brake)	G/L	01/00 ->	356306		1782/1560	GVC902382-SPB000370
	D/R	01/00 ->	356307		1812/1588	GVC902383-SPB000360
MG ZS						
MG ZS all model sans/without ABS (freins à tambours/drum brake)	G/L	01/00 ->	356311		1485/1320	GVC902375-SPB101290
	D/R	01/00 ->	356310		1512/1341	GVC902376-SPB100700
MG ZS all model avec/with ABS (freins à disques/disc brake)	G/L	01/00 ->	356304		1636/1449	GVC902389-SPB100730
	D/R	01/00 ->	356305		1655/1469	GVC902388-SPB100720
MG ZT						
MG ZT all model	G/L or D/R	06/99 ->	554410		1570/1462x2	GVC902399-SPB101550 Kit:SPB000230
MG STREET WISE						
STREETWISE		10/03 ->	Not available			

MINI (BMW)						
MINI						
MINI (R50-R53) all model	G/L	09/01 -> 07/04	554330	805060	1444/1300	34411514215
	D/R	09/01 -> 07/04	554331		1444/1300	34411514214

Véhicule Vehicle	Position	Année Year	SEIM P/n	Kit P/n	Longueur Lenght	OE
MINI (BMW)						
<i>Suite...</i>						
MINI (suite)						
MINI (R50-R53) all model	G/L	07/04 -> 09/06	554334		1433/1290	34406777400
	D/R	07/04 -> 09/06	554335		1435/1294	34406777399
MINI (R56) all model sauf/except Clubman	G/L	11/06 ->	554332	805061	1393/1244	34406769955
	D/R	11/06 ->	554333		1402/1255	34406769954
MINI (R55) all model CLUBMAN	G/L	11/07 ->	554336		1474/1324	34406770869
	D/R	11/07 ->	554337		1483/1334	34406770868
MINI (R52) all model cabriolet/convertible	G/L	07/04 -> 03/09	554334		1433/1290	34406777400
	D/R	07/04 -> 03/09	554335		1435/1294	34406777399
MINI (R57) all model cabriolet/convertible	G/L	03/09 ->	554332	805061	1393/1244	34406769955
	D/R	03/09 ->	554333		1402/1255	34406769954
MINI (R60) COUNTRYMAN all model	G/L	03/09 ->	NEW 555043		1552/1443	34409803367
	D/R	03/09 ->	NEW 555044		1499/1388	34409803368
MITSUBISHI						
ASX						
ASX all model 2WD	G/L	06/10 ->	NEW 555046		1645/1430	4820A025
	D/R	06/10 ->	NEW 555045		1627/1415	4820A026
ASX all model 4WD	G/L	06/10 ->	NEW 555046		1645/1430	4820A025
	D/R	06/10 ->	NEW 555047		1632/1418	4820A038
COLT						
COLT		10/83 -> 05/04	Not available			
COLT VI 1.1 all model (freins à tambours/drum brake)	G/L	06/04 ->	554430	805084	1525/13315	MR955255
	D/R	06/04 ->	554431		1560/1345	MR955256
COLT VI 1.3 1.5 1.5D all model (freins à disques/disc brake)	G/L	06/04 ->	554432	805085	1540/1390	MR955259
	D/R	06/04 ->	554433		1570/1420	MR955260
L200						
L200 II 2.5 TD 4WD	G/L	09/96 -> 03/06	NEW 555048		1997/1790	MR128203
	D/R	09/96 -> 03/06	NEW 555049		1994/1780	MR128204
L200 II 2.8 TD 4WD	G/L	09/96 -> 03/06	NEW 555050		1720/1392	MR128199
	D/R	09/96 -> 03/06	NEW 555051		2360/2037	MR128200
L200 III 2.5 DHD	Primaire Front	03/06 ->	NEW 555052		244	MN102418
L200 III 2.5 DHD	G/L	03/06 ->	NEW 555053		2023/1795	MN102416
	D/R	03/06 ->	NEW 555054		2018/1788	MN102417
OUTLANDER						
OUTLANDER II all model	G/L	05/03->12/06	Not available			MN102297
	D/R	05/03->12/06	Not available			MN102298
OUTLANDER II all model	G/L	03/07->12/09	554053	805023		474632-4820A104
	D/R	03/07->12/09	554054			474633-4820A103
OUTLANDER IV all model 2WD	G/L	09/12 ->	Not available			4820A261
	D/R	09/12 ->	Not available			4820A262
OUTLANDER IV all model 4WD	G/L	09/12 ->	Not available			4820A261
	D/R	09/12 ->	Not available			4820A264
PAJERO & SHOGUN						
PAJERO & SHOGUN 90/105cv (66/77 KW)	Primaire Front	09/98 ->	354200		220	MR128810
PAJERO & SHOGUN 90cv (66KW)	G/L	09/98 ->	354301		1340/1135	MR475597
	D/R	09/98 ->	354300		1387/1182	MR475598
PAJERO & SHOGUN 105 cv (77KW)	G/L	09/98 ->	354303		1462/1256	MR475603
	D/R	09/98 ->	354302		1559/1354	MR475604
SPACE WAGON & SPACE STAR						
SPACE WAGON		08/83 ->	Not available			
SPACE STAR		09/98 ->	Not available			

Véhicule Vehicle	Position	Année Year	SEIM P/n	Kit P/n	Longueur Lenght	OE
NISSAN						
ALMERA						
ALMERA I (N15) all model	Primaire Front	10/95 -> 03/00	Not available		236	364024M600-364024V910
ALMERA I (N15) 1.4-1.6-2.0D	G/L	10/95 -> 04/98	710312		1660/1440	365310M010-365311N900
	D/R	10/95 -> 04/98	710314		1662/1442	365300M010-365301N900
ALMERA I (N15) 1.4-1.6-2.0D & 2.0GTI avec/with ABS	G/L	10/95 -> 04/98	710316		1680/1480	365310M810-365310N600
	D/R	10/95 -> 04/98	710318		1677/1474	365300M810-365300N600
ALMERA II (N16) & ALMERA TINO all model	Primaire Front	03/00 -> 12/05	710218		215	36402BM600
ALMERA II (N16) all model sans/without ABS	G/L	03/00 -> 12/05	710320		1630/1450	365319M800
	D/R	03/00 -> 12/05	710319		1640/1465	365309M800
ALMERA II (N16) all model avec/with ABS	G/L	03/00 -> 12/05	710321		1650/1495	36531BM700-36531BN80A
	D/R	03/00 -> 12/05	554731		1665/1505	36530BM700-36530BN80A
ALMERA TINO all model	G/L	03/00 -> 09/06	710323		1660/1505	36531BU80A-36531BU000
	D/R	03/00 -> 09/06	710322		1665/1515	36530BU80A-36530BU000
CABSTAR						
CABSTAR (F23) all model avec double essieux/ with double axle	G/L	11/98 -> 05/01	NEW 555057		2005/800	36531F3900
	D/R	11/98 -> 05/01	NEW 555058		1137/800	36530F3900
CABSTAR (F23) all model avec double essieux/ with double axle	G/L	06/01 -> 12/03	NEW 555055		2055/802	36531F3904
	D/R	06/01 -> 12/03	NEW 555056		1190/803	36530F3904
CABSTAR (F24) all model	G/L	08/00 -> 10/06	NEW 555067		1271/1048	364529X50B-36452X503
	D/R	08/00 -> 10/06	NEW 555068		1130/905	364529X50A-364529X502
CABSTAR (F24) all model avec double essieux/ with double axle	G/L	10/06 -> 06/09	NEW 555069		896/740	36531MB00B
	D/R	10/06 -> 06/09	NEW 555070		896/740	36530MB00B
CABSTAR (F24) 35T 2.5TD	G/L	10/06 -> 06/09	NEW 555061		985/828	36531MB00A
	D/R	10/06 -> 06/09	NEW 555062		985/827	36530MB00A
CABSTAR (F24) 45T 2.5TD	G/L	10/06 -> 06/09	NEW 555065		1080/908	36531MB00C
	D/R	10/06 -> 06/09	NEW 555066		1080/908	36530MB00C
CABSTAR (F24) 28T-32T all model	G/L	07/09 ->	NEW 555059		985/828	36531MB00D
	D/R	07/09 ->	NEW 555060		985/828	36530MB00D
CABSTAR (F24) 35T all model	G/L	07/09 ->	NEW 555063		898/742	36531MB00E
	D/R	07/09 ->	NEW 555064		898/742	36530MB00E
INTERSTAR						
INTERSTAR all model	Primaire Front	03/02 ->	404977		1175/946	3640200QAA-8200694124-8200021935
INTERSTAR (freins à tambours/drum brake)	G/L or D/R	03/02 ->	404975		1420/1048	3640000QAA-7700311217
INTERSTAR (freins à disques/disc brake)	G/L or D/R	03/02 ->	404976		1737/1439	3640000QAB-3640000Q0C-8200694128-8200021940
JUKE						
JUKE 1.6 117cv-1.6 DIGT 190cv-1.5 DCI 110cv	Primaire Front	09/10	NEW 555178		230	364021KA0A
JUKE 1.6 117cv-1.6 DIGT 190cv-1.5 DCI 110cv	G/L	09/10->	NEW 555179		1672/1505	365311KK0A
	D/R	09/10->	NEW 555180		1700/1532	365301KK0A
KUBISTAR						
KUBISTAR all model charge utile/ payload 600 kg	G/L	01/03 ->	404760	804760	1423/1060	36531QAE-7700311698
	D/R	01/03 ->	404770		1420/1080	36530QAE-7700311699
KUBISTAR all model charge utile/ payload 800 kg	G/L	01/03 ->	404780	804780	1430/1050	36531QAF-7700311700-8200694080
	D/R	01/03 ->	404790		1440/1060	36530QAF-7700311701-8200694083
MICRA						
MICRA (N10-N12)	G/L	88 -> 10/92	710300		1000/740	3653121B00
	D/R	88 -> 10/92	710301		1355/1100	3640021B00
MICRA (K11) all model	Primaire Front	10/92 -> 12/02	710302		250	3640270J10
MICRA (K11) all model (freins à tambours/drum brake)	G/L	10/92 -> 12/02	713040	813040	1410/1200	365314F100
	D/R	10/92 -> 12/02	713050		1435/1225	365304F100

Véhicule Vehicle	Position	Année Year	SEIM P/n	Kit P/n	Longueur Lenght	OE
NISSAN						
MICRA (suite)						
MICRA (K11) all model (freins à disques/disc brake)	G/L	10/92 -> 12/02	554344		1287/1070	365314F400
	D/R	10/92 -> 12/02	554345		1310/1093	365304F400
MICRA (K12) all model	Primaire Front	01/03 ->	554346		200	36402AX000
MICRA (K12) all model	G/L	01/03 ->	554347	805062	1540/1327	36531AX601-36531AX600 36531AX60A
	D/R	01/03 ->	554348		1604/1387	36530AX601-36530AX600 36530AX60A
NAVARA						
NAVARA (D40) all model	G/L	08/05 -> 03/10 ->	NEW 555074		2440/2187	365313X30A
	D/R	08/05 -> 03/10 ->	NEW 555075		2211/1965	365303X30A
NOTE						
NOTE all model	Primaire Front	03/06 ->	554346		200	36402AX000
NOTE all model	G/L	03/06 ->	554349	805063	1706/1494	365319U00A-
	D/R	03/06 ->	554350		1770/1555	365309U00A
NP 300 Pick up						
NP 300 Pick up all model	G/L	07/08 ->	NEW 555076		2250/1505	36531VK000-36531VK00A
	D/R	07/08 ->	NEW 555077		1730/1446	36530VK000-36530VK00A
PIXO						
PIXO all model	G/L	06/09 ->	554687			365314A00B-54402M68K00
	D/R	06/09 ->	554688			365304A00C-54401M68K00
PRIMASTAR						
PRIMASTAR all model	Primaire Front	09/01 -> 05/06 05/06 ->	653152		502/260	93864341-91166639 3640200QAB-4421102-4408726 365301862R-7700312835
PRIMASTAR all model chassis court/ short wheelbase	Intermediate	09/01 -> 05/06 05/06 ->	653299		1185	3651800QAA-7700313058- 91165521-4408735
PRIMASTAR all model chassis long/ long wheelbase	Intermediate	09/01 -> 05/06 05/06 ->	404982		1585	3651800QAC-3651800QAB- 8200008473-4408730 91165522
PRIMASTAR all model	G/L	09/01 -> 05/06 05/06 ->	404983		1503/1365	3653100QAD-3653100QAC 8200263819-8200178389 7700312837-4414821-93852188 4408734-4411413-91168672
	D/R	09/01 -> 05/06 05/06 ->	404984		1603/1465	3653000QAD-3653000QAC 8200263821-8200178390 7700312836-4414822-93852189 4408727-4411415-91168673
PRIMERA						
PRIMERA break/SW (W10) all model	Primaire Front	10/90 -> 06/95	713235		250	364025QJ10-364027QJ10
PRIMERA break/SW (W10) all model 1.6 2.0D	G/L	10/90 -> 06/95	713332		1582/1360	3653170N00
	D/R	10/90 -> 06/95	713331		1610/1390	3653070N00
PRIMERA break/SW (W10) all model avec/ with ABS	G/L	10/90 -> 06/95	713334		1476/1277	3653178N00
	D/R	10/90 -> 06/95	713333		1504/1307	3653078N00
PRIMERA (P10) all model	Primaire Front	10/90 -> 09/96	713235		250	364025QJ10-364027QJ10
PRIMERA (P10) 1.6 & 2.0D (freins à tambours/drum brake)	G/L	10/90 -> 09/96	713336		1625/1420	3653170J10
	D/R	10/90 -> 09/96	713337		1605/1395	3653070J10
PRIMERA (P10) 2.0 (freins à disques/disc brake)	G/L	10/90 -> 09/96	713338		1510/1340	3653171J10
	D/R	10/90 -> 09/96	713339		1490/1315	3653071J10
PRIMERA (P11) all model	Primaire Front	10/96 -> 03/02	713346		303	364022F000

Véhicule Vehicle	Position	Année Year	SEIM P/n	Kit P/n	Longueur Lenght	OE
NISSAN						
PRIMERA (suite)						
PRIMERA & PRIMERA break/SW (P11) 1.6 & 2.0TD (freins à tambours/drum brake)	G/L	10/96 -> 09/99	713341		1620/1343	365312F000
	D/R	10/96 -> 09/99	713340		1640/1360	365302F000
PRIMERA & PRIMERA break/SW (P11) 1.6 & 2.0TD (freins à disques/disc brake)	G/L	10/96 -> 09/99	713343		1632/1395	365312F200
	D/R	10/96 -> 09/99	713342		1657/1426	365302F200
PRIMERA & PRIMERA break/SW (P11) 1.6-1.8-2.0 & 2.0TD (freins à disques/disc brake)	G/L	09/99 -> 03/01	713345		1642/1405	365319F000-365310F500 365309F510
	D/R	09/99 -> 03/01	713344		1668/1432	365309F000-365300F500 365319F510
PRIMERA & PRIMERA break/SW (P11) 1.6 1.8 2.0 & 2.0TD (freins à disques/disc brake)	G/L	03/01 -> 03/02	713348		1635/1397	365319F500
	D/R	03/01 -> 03/02	713347		1660/1423	365309F500
PRIMERA (P12) all model	Primaire Front	03/02 -> 12/06	554351		236	36402AV910-364024M600
PRIMERA (P12) all model (freins à disques/disc brake)	G/L	03/02 -> 12/06	554352	805064	1778/1628	36531BA00B-36531AV601 36531AV600
	D/R	03/02 -> 12/06	554353		1778/1628	36530BA00B-36530AV601 36530AV600
QASHQAI						
QASHQAI all model	Primaire Front	01/07 ->	NEW 555078			36402JD00A
QASHQAI all model (5 sièges/seats)	G/L	01/07 ->	NEW 555079		1703/1523	36531JD00A
	D/R	01/07 ->	NEW 555080		1705/1524	36530JD00A
QASHQAI+2 all model (7 sièges/seats)	G/L	10/08 ->	NEW 555081		1833/1647	36531EY10A
	D/R	10/08 ->	NEW 555082		1835/1647	36530EY10A
SERENA						
SERENA		93 ->	Not available			
SUNNY						
SUNNY all model		86 ->	Not available		315	3640251E00
TERRANO						
TERRANO (R20) all model	Primaire Front		Not available			
TERRANO (R20) all model 3 portes/doors	G/L	10/93 -> 11/99	713300	813300	1325/1115	365310F000-365310F001
	D/R	10/93 -> 11/99	713301		1355/1150	365300F000-365300F001
TERRANO (R20) all model 5 portes/doors	G/L	10/93 -> 11/99	713302	813303	1470/1255	365310F600-365310F601
	D/R	10/93 -> 11/99	713303		1480/1270	365300F600-365300F601
TERRANO II all model	Primaire Front		Not available			
TERRANO II all model 3 portes/doors (freins à tambour/drum brake)	G/L	12/99 ->	554356	805066	1365/1100	365310X800
	D/R	12/99 ->	554357		1394/1128	365300X800
TERRANO II all model 5 portes/doors (freins à tambour/drum brake)	G/L	12/99 ->	554358	805067	1510/1245	365310X900
	D/R	12/99 ->	554359		1520/1256	365300X900
VANETTE						
VANETTE 1.5 LD 20	Primaire Front	87 -> 92	710228		2775/2610	36402Y9503
VANETTE 1.5 LD 20	Unique Single	87 -> 92	710230		1875	36400Y9503
X-TRAIL						
X-TRAIL (T30) all model	Primaire Front	07/01 -> 11/07	554351		236	364024M60A-364024M600
X-TRAIL (T30) all model	G/L	07/01 -> 11/07	554361	805068	1745/1608	365318H30A-365318H30B
	D/R	07/01 -> 11/07	554362		1736/1598	365308H30A-365308H30B
X-TRAIL II (T31) all model	Primaire Front	07/07 ->	NEW 555083		317	36402JG00A
X-TRAIL II (T31) all model	G/L	07/07 ->	NEW 555084		1697/1510	365311G00A
	D/R	07/07 ->	NEW 555085		1697/1510	365301JG00A

Véhicule Vehicle	Position	Année Year	SEIM P/n	Kit P/n	Longueur Length	OE
OPEL						
AGILA						
AGILA all model	G/L	05/00 -> Ch. n°1G075421	653281	853283	1516/1302	4705708-4700358-9210314
	D/R	05/00 -> Ch. n°1G075421	653284		1507/1291	4700357-4705631-9203995
AGILA all model	G/L	Ch. n°1G075422 -> Ch. 2G999999	653281	853281	1516/1302	4705708-47000358-9210314
	D/R	Ch. n°1G075422 -> Ch. 2G999999	653282		1498/1285	4705707-9210312
AGILA all model	G/L	Ch. n°3G000001-> 02/08	653302	853302	1536/1281	4706689-9211156 5442084E00
	D/R	Ch. n°3G000001-> 02/08	653303		1530/1281	4706688-9211155 5441084E00
AGILA all model	G/L	03/08 ->	554691		1600/1368	4709864-93195342 5440251K00
	D/R	03/08 ->	554692		1600/1368	4709863-93195341 5440151K00
ANTARA						
ANTARA all model	G/L	01/07 ->	554078			4804783-96625953-96879436
	D/R	01/07 ->	554079			4804784-96625954-96879437
ASCONA						
ASCONA C all model	G/L	86 ->	653080		756	522569
	D/R	86 ->	653030		2035	522570-90189718
ASTRA (F)						
ASTRA (F) all model sauf/ except 1.816v-2.0 115 cv- 2.016v, cabriolet/ convertible & SW (freins à tambours/drum brake)	Unique Single	09/91 -> 03/98	653040		1272/690+ 1692/1090	522641-522603-90373923 90289824-90538698
ASTRA (F) 1.816v-2.0115 cv-2.0 16v & cabriolet/convertible sauf/except SW (break) (freins à disques/disc brake)	Unique Single	09/91 -> 03/98	653230		1175/692+ 1575/1092	522532-90373855
ASTRA (F) SWV (break) sauf/except 1.8 16v & 2.0 16v (freins à tambours/drum brake)	Unique Single	09/91 -> 03/98	653100		1287/705+ 1398/820	522600-522640-90538629
ASTRA (F) SWV (break) 1.8 16v & 2.0 16v (freins à disques/disc brake)	Unique Single	09/91 -> 03/98	653140		1168/708+ 1280/820	522628-90496316
ASTRA (G)						
ASTRA (G) all model	Primaire Front	04/98 -> 03/04	653298		280	522551-09127937
ASTRA (G) all model (freins à tambours/drum brake)	Intermediate	04/98 -> 99	554365		2x1252/ 1060	522650-09127787
ASTRA (G) all model (freins à tambours/drum brake)	Intermediate	00 -> 03	554366		2x1254/ 1060	522656-24436451
ASTRA (G) all model (freins à tambours/drum brake)	Intermediate	03 -> 03/04	653241		2x1355/ 1157	522153-522558 90581267-24436467
ASTRA (G) all model (freins à tambours/drum brake)	Liaison G/L or D/R	04/98 -> 03/04	653285		182	522653-5226549127527 -9127518-52205-18045189
ASTRA (G) all model (freins à disques/disc brake)	Unique Single	04/98 ->Ch.Y2252431 04/98 ->Ch.Y5258809 04/98 ->Ch.Y6117453 04/98 ->Ch.Y8130099	554648		2x1577/ 1403	522440-522544-522651 9127791-9191143
ASTRA (G) all model (freins à disques/disc brake) BOSCH brake system	Unique Single	Ch. Y2252432 ->03/04 Ch. Y5258810 ->03/04 Ch. Y6117453 ->03/04 Ch. Y8130100 ->03/04 Ch. Y28006254 ->03/04 Ch. Y25003001 ->03/04	653240		2x1593/ 1400	522657-522001-522003 24425108-9223129
ASTRA (G) all model (freins à disques/disc brake) LUCAS brake system	Unique Single	Ch. 28006255-> 03 Ch. 25003002-> 03	653287		2x1592/ 1403	522007-522528-24465148

Véhicule Vehicle	Position	Année Year	SEIM P/n	Kit P/n	Longueur Lenght	OE
OPEL Suite...						
ASTRA (G) (suite)						
ASTRA (G)TT (freins à disques/disc brake)	Unique Single	Ch. 4200001->03/04 Ch. 4500001->03/04 Ch. 4600000->03/04 Ch. 4800001->03/04 Ch. 4B00001->03/04	554727		2x1587/ 1400	522453-13153654
ASTRA (H & I)						
ASTRA (H) all model (freins à tambours/drum brake)	Intermediate	04/04 ->	554367		1326/1156+ 1293/1085	522035-13237273-522455 13157061-522031-13220101 522035-13237273
ASTRA (H) all model (freins à tambours/drum brake)	Liaison G/L or D/R	04/04 ->	653285		182	522005-18045189-522653 522654-9127527-9127518 522005-18045189
ASTRA (H) all model sauf/except SW (break) (freins à disques/disc brake)	Unique Single	04/04 ->	653306		1643/1460+ 1675/1491	522456-13157062-522029 13220099-522033-13237271
ASTRA (H) SW all model (freins à disques/disc brake)	Unique Single	04/04 ->	653307		1733/1548+ 1760/1578	522027-13157063-522030 13220100-522034-13237272
ASTRA (I) all model sauf frein à main automatique/ except automatic brake	Unique Single	12/09 ->	NEW 554868			522063-13328132
ASTRA (J)						
ASTRA (J) all model sauf/except GTC	G/L	10/10 ->	NEW 555086		971/605	522097-13367627
	D/R	10/10 ->	NEW 555087		1814/1687	522098-13367628
CORSA (A)						
CORSA (A) all model	G/L	82 -> 86	Not available		822/340	522548-90125513
	D/R	82 -> 86	Not available		1435/716	522549-90125512
CORSA (A) all model	G/L	86 -> 90	650240		960	522571-522587-90193039
	D/R	86 -> 90	650250		1400/720	522572-90223404
CORSA (A) all model	G/L	Ch. CN4052761-> 92	653190		1262/651	522593
	D/R	Ch. CN4052761-> 92	653180		1035	522594
CORSA (B)						
CORSA (B) all model	G/L	03/93 -> 10/00	653170	853170	1370	522615-522643 90445985-90538700
	D/R	03/93 -> 10/00	653160		1080	522614-522642 90445986-90538699
CORSA (C)						
CORSA (C) all model sauf/except GSI & SPORT	Primaire Front	10/00 -> 09/06	554371		330	522445-9127187
CORSA (C) 1.0 12v-1.2 16v-1.7DI (freins à tambours/drum brake)	G/L	10/00 -> 08/03	554372		1095/756	522448-90576453-266713176
	D/R	10/00 -> 08/03	554374		832	522449-90576454
CORSA (C) 1.7DTI (freins à tambours/drum brake)	G/L	10/00 -> 08/03	554373		1105/756	522655-24443834
	D/R	10/00 -> 08/03	554374		832	522449-90576454
CORSA (C) 1.4 16v (freins à tambours/drum brake)	G/L	10/00 ->Ch.34999999 10/00 ->Ch.36999999	554373		1106/757	522655-24443834
	D/R	10/00 ->Ch.34999999 10/00 ->Ch.36999999	554374		832	522449-90576454
CORSA (C) 1.4 16v (freins à disques/disc brake)	G/L	Ch.4400001->08/03 Ch. 4600001->08/03	653309		1426/756+ 307	522015-13138929
	D/R	Ch.4400001->08/03 Ch. 4600001->08/03	653308		1143/307	522014-13138930
CORSA (C) 1.0 12v & 1.3 CDTI (freins à tambours/drum brake)	G/L	08/03 -> 09/06	554372		1095/757	522448-90576453
	D/R	08/03 -> 09/06	554374		832	522449-90576454
CORSA (C) 1.0 12v-1.2 16v-1.4 16v-1.3CDTI & 1.7CDTI (freins à tambours/drum brake)	G/L	08/03 -> 09/06	554373		1106/757	522655-24443834
	D/R	08/03 -> 09/06	554374		832	522449-90576454
CORSA (C) all model sans/without ABS (freins à tambours/drum brake)	Liaison G/L or D/R	10/00 -> 09/06	653288		220	522151-93170228

Véhicule Vehicle	Position	Année Year	SEIM P/n	Kit P/n	Longueur Length	OE
OPEL						
						<i>Suite...</i>
CORSA (C) (suite)						
CORSA (C) all model avec/with ABS (freins à tambours/drum brake)	Liaison G/L or D/R	10/00 -> 09/06	554728		220	522152-93170227
CORSA (C) 1.8 16v GSI (freins à disques/disc brake)	G/L	10/00 -> Ch.34387269	653305		1425/762+ 367	522447-9191578
	D/R	10/00 -> Ch.34387269	653304		1143/370	522446-9191574
CORSA (C) 1.8 16v GSI ou SPORT (freins à disques/disc brake)	G/L	Ch.34387269 > 09/06	653309		1426/756+ 307	522015-13138929
	D/R	Ch.34387269 > 09/06	653308		1143/307	522014-13138930
CORSA (D)						
CORSA (D) all model	Primaire Front	07 ->	554378		430	574127 (seulement câble)
CORSA (D) 3 portes/doors 1.0 60cv-1.2 80cv-1.2 GPL	Unique Single	09/06 > 12/10	554379		1477/1260+	522082-522060
					1462/1246	13355089-522044-13255757
CORSA (D) 3 portes/doors 1.0 65cv-1.2 85cv-1.2 GPL	Unique Single	01-2011 >	554379		1477/1260+	522082-522060-13355089
					1462/1246	522044-13255757
CORSA (D) 3 portes/doors 1.4 Turbo 90 & 100cv	Unique Single	09/06 > 12/10	554376		1492/1255+	522039-13214178
					1477/1242	
CORSA (D) 3 portes/doors 1.4 Turbo 100cv	Unique Single	01-2011 >	554380		1492/1255+	522081-522043-13255756
					1477/1242	522061-13355088
CORSA (D) 3 portes/doors 1.3 CDTI 75,90 & 95cv	Unique Single	09/06 > A6999999 09/06 > A4999999	554379		1477/1260+	522082-522060-13355089
					1462/1246	522044-13255757
CORSA (D) 3 portes/doors 1.3 CDTI 75,90 & 95cv	Unique Single	B4000001 > 12-2010 B6000001 > 12-2010	554380		1492/1255+	522081-522043-13255756
					1477/1242	522061-13355088
CORSA (D) 3 portes/doors 1.3 CDTI 75cv	Unique Single	01-2011 >	554380		1492/1255+	522081-522043-13255756
					1477/1242	522061-13355088
CORSA (D) 3 portes/doors 1.3 CDTI 95cv	Unique Single	01-2011 >	554376		1492/1255+	522039-13214178
					1477/1242	
CORSA (D) 3 portes/doors 1.6 turbo GSI & OPC-1.7 CDTI 125cv (freins à disques/disc brake)	Unique Single	09/06 > 12/10 1462/1292	554377		1475/1307+	522038-13214177
CORSA (D) 3 portes/doors 1.6 turbo OPC (freins à disques/disc brake)	Unique Single	01-2011 >	554381		1475/1307+	522080-522062-522042
					1462/1292	13255755-13355087-13332851
CORSA (D) 3 portes/doors 1.7 CDTI 130cv (freins à disques/disc brake)	Unique Single	09/06 > 12/10	554381		1475/1307+	522062-522042-522080
					1462/1292	13255755-13355087-13332851
CORSA (D) 3 portes/doors 1.7 CDTI 130cv (freins à disques/disc brake)	Unique Single	01-2011 >	554381		1475/1307+	522080-522062-522042
					1462/1292	13255755-13355087-13332851
CORSA (D) 5 portes/doors 1.2 80 & 85cv-1.2 GPL	Unique Single	09/06 > 12/10	554376		1492/1255+	522039-13214178
					1477/1242	
CORSA (D) 5 portes/doors 1.2 85cv	Unique Single	01-2011 >	554380		1492/1255+	522061-522081-522043
					1477/1242	13255756-522061-13355088
CORSA (D) 5 portes/doors 1.4 Turbo 90 & 100cv	Unique Single	09/06 > 12/10	554376		1492/1255+	522039-13214178
					1477/1242	
CORSA (D) 5 portes/doors 1.4 Turbo 100cv	Unique Single	01-2011 >	554380		1492/1255+	522081-522043-13255756
					1477/1242	522061-13355088
CORSA (D) 5 portes/doors 1.3 CDTI 75,90 & 95cv	Unique Single	09/06 > A6999999 09/06 > A4999999	554379		1477/1260+	522082-522060-13355089
					1462/1246	522044-13255757
CORSA (D) 5 portes/doors 1.3 CDTI 75,90 & 95cv	Unique Single	B4000001 > 12-2010 B6000001 > 12-2010	554380		1492/1255+	522081-522043-13255756
					1477/1242	522061-13355088
CORSA (D) 5 portes/doors 1.3 CDTI 75cv	Unique Single	01-2011 >	554380		1492/1255+	522081-522043-13255756
					1477/1242	522061-13355088
CORSA (D) 5 portes/doors 1.3 CDTI 95cv	Unique Single	01-2011 >	554376		1492/1255+	522039-13214178
					1477/1242	
CORSA (D) 5 portes/doors 1.7 CDTI 125cv (freins à disques/disc brake)	Unique Single	09/06 > 12/10	554377		1475/1307+	522038-13214177
					1462/1292	
CORSA (D) 5 portes/doors 1.7 CDTI 130cv (freins à disques/disc brake)	Unique Single	09/06 > 12/10	554381		1475/1307+	522062-522042-522080
					1462/1292	13255755-13355087-13332851

Véhicule Vehicle	Position	Année Year	SEIM P/n	Kit P/n	Longueur Length	OE
OPEL Suite...						
CORSA (D) (suite)						
CORSA (D) 5 portes/doors 1.7 CDTI 130cv (freins à disques/disc brake)	Unique Single	01/11->	554381		1475/1307+ 1462/1292	522080-522062-522042 13255755-13355087-13332851
CORSA COMBO						
CORSA (B) Combo all model	Unique Single	12/93 -> 09/00	653200		1660X1520 X1310	522618-522000 90447335-9191225
CORSA (C) Combo all model	Primaire Front	01 ->	554368		445	522013-9225545
CORSA (C) Combo all model (freins à tambour/drum brake)	Intermediate	01 ->	554369		2x1235/ 1040	522150-522450-9225541 24468130
CORSA (C) Combo all model (freins à tambour/drum brake)	Liaison G/L or D/R	01 ->	653285		182	522653-522654-9127527 9127518-52205-18045189
CORSA (C) Combo all model (freins disques)	Unique Single	01 ->	554370		2x1582/ 1407	522017-13172730
FRONTERA						
FRONTERA 3 & 5 portes/doors		05/92 -> 96	Not available			
FRONTERA (A) all model 3 portes/doors (freins à tambour/drum brake)	G/L	07/96 -> 10/98	554382		1500/1315	522425-91152687
	D/R	07/96 -> 10/98	554383		1500/1315	522424-91152686
FRONTERA (B) all model 3 portes/doors	G/L	10/98 -> 02/05	NEW 555150		1510/1334	522516-97124836
	D/R	10/98 -> 02/05	NEW 555071		1510/1334	522517-97203939
FRONTERA (A) all model 5 portes/doors (freins à tambour/drum brake)	G/L	07/96 -> 10/98	554384		1936/1315	522427-91152689
	D/R	07/96 -> 10/98	554385		1936/1315	522426-91152688
FRONTERA (B) all model 5 portes/doors	G/L	10/98 -> 02/05	NEW 555072		1765/1590	522510-97124834
	D/R	10/98 -> 02/05	NEW 555073		1744/1564	522506-522074-97324410
INSIGNA						
INSIGNA all model sauf/except 4x4	G/L or D/R	01/09->	554729			522057-13323804 522047-13250177
INSIGNA 4x4 all model	G/L or D/R	01/09->	554730			522046-13227133
KADETT						
KADETT C D & E all model		73 -> 10/91	Not available			
MERIVA						
MERIVA all model	Unique Single	04/03 -> Ch. n°34999999	554386		1610/1438x2	522012-93318894
MERIVA all model	Unique Single	Ch. n°44000000->	554387		1615/1438x2	522016-13159021
MOVANO						
MOVANO all model	Primaire Front	01/99 -> 05/06	404977		1175/946	9160550-4403487-4500250 9111487-4418463 93193020-8200021935
MOVANO all model (freins à tambours/drum brake)	G/L or D/R	01/99 -> 05/06	404975		1420/1048	9160551-4500251 7700311217
MOVANO all model (freins à disques/disc brake)	G/L or D/R	01/99 -> 05/06	404976		1737/1439	9111490-4403490-8200021940
OMEGA						
OMEGA all model		10/86 -> 12/99	Not available			
SENATOR						
SENATOR		08/87 ->	Not available			
SIGNUM						
SIGNUM all model essence/gasoline (freins à disques/disc brake)	Unique Single	05/03 ->	554388		2x1805/ 1633	522021-522025-93181109 13162335-24407651-522009 522022-522024-13106485
SIGNUM all model diesel (freins à disques/disc brake)	Unique Single	05/03 ->	554389		2x1805/ 1633	522026-522020-522011 93181108-93151110-13162337
SINTRA						
SINTRA all model		96 ->	Not available			
TIGRA						
TIGRA all model		09/94 -> 05/04	Not available			

Véhicule Vehicle	Position	Année Year	SEIM P/n	Kit P/n	Longueur Lenght	OE
OPEL						
						<i>Suite...</i>
TIGRA (suite)						
TIGRA all model	G/L	09/94>09/00	653170	853170	1370	522615-522643-90445985 90538700
	D/R	09/94>09/00	653160		1080	522614-522642-90445986 90538699
TIGRA TWINTOP all model (freins à tambours/drum brake)	G/L	06/04 ->	554372		1095/756	522448-90576453-266713176
	D/R	06/04 ->	554374		832	522449-90576454
TIGRA TWINTOP all model (freins à disques/disc brake)	G/L	06/04 ->	653309		1426/756+ 307	522015-13138929
	D/R	06/04 ->	653308		1143/307	522014-13138930
TIGRA TWINTOP all model	Liaison G/L or D/R	06/04 ->	554728		220	522152-93170227
VECTRA (A)						
VECTRA (A) all model	Primaire Front	09/88 ->	652140		315	522409-90495463
VECTRA (A) 1.4-1.6-1.8-1.7D-1.7TD	G/L	09/88 ->Ch. K1055983	Not available		756	522590-522569-90344899
	D/R	09/88 ->Ch. K1055983	Not available		2080/1022	522588-522583-90344447
VECTRA (A) 1.4-1.6-1.8-1.7D-1.7TD	G/L	Ch. K1055984> 06/95	653080		756	522597-522601-90421703
	D/R	Ch. K1055984> 12/89	653090		2080/1022	522596-522602-90421704
	D/R	90 -> 06/95	Not available		2120/1062	522620-90334824-90495223
VECTRA (A) 2.0 & 2.5 V6	G/L	09/88 ->Ch. K1055983	Not available		665	522581-90297927
	D/R	09/88 ->Ch. K1055983	Not available		2003/1045	522582-522598-90375404
VECTRA (A) 2.0 & 2,5 V6	G/L	n°ch -> 06/95	653260	853260	665	522599-522589-90375403
	D/R	n°ch -> 06/95	653261		2022/1061	522621-90495224
VECTRA (A) 4x4 all model	Unique Single	09/88 ->Ch. 1092928	Not available		1350/940+ 1500/1100	522585-90334462
	Unique Single	Ch. 1092929> 06/95	Not available		1365/953+ 1498/1099	522595-90374902
VECTRA (B)						
VECTRA (B) all model	Primaire Front	11/95 -> 97	652140		315	522409-90495463
VECTRA (B) all model	Primaire Front	98 ->	653298		280	522551-09127937
VECTRA (B) all model (freins à tambours ou disques/drum or disc brake)	Intermediate	11/95 -> 06/02	653270		2x1455/ 1226	522412-522524-90468900
VECTRA (B) all model sauf/except 2.0 Diesel (freins à tambours/drum brake)	Liaison G/L or D/R	11/95 -> 06/02	653291		210	522411-522414 90496486-90538631
VECTRA (B) 2.0 Diesel (freins à tambours/drum brake)	Liaison G/L or D/R	11/95 -> 06/02	653288		220	522417-90575127
VECTRA (B) all model (freins à disques/disc brake)	Liaison G/L or D/R	11/95 -> 06/02	653292		130	522410-90496487
VECTRA (C)						
VECTRA (C) all model sauf/except break/SW (freins à disques/disc brake)	Unique Single	05/02 ->	653271		1630/1454+ 1578/1397	522018-522019-522023 522452-24455114-522451 9191216-522006-13106484 93181107-93181106
VECTRA (C) SW (break) 1.8i-2.0Turbo & 2.2i (freins à disques/disc brake)	Unique Single	05/02 ->	554388		2x1805/ 1633	522021-522025-522009 522022-522024-13106485 93181109-13162335-24407651
VECTRA (C) SW (break) 1.9CDTI 120 & 150cv 2.2DTI16v-3.0CDTI (freins à disques/disc brake)	Unique Single	05/02 ->	554389		1805/1633+ 1800/1625	522020-93181108-522011 93181110-522026-13162337
VIVARO						
VIVARO all model	Primaire Front	10/01 -> 08/06 08/06 ->	653152		49/8200	365301862R-93864341 4421102-4408726-91166639 7700312835-3640200QAB

Véhicule Vehicle	Position	Année Year	SEIM P/n	Kit P/n	Longueur Lenght	OE
OPEL Suite...						
VIVARO (suite)						
VIVARO all model chassis court/short wheelbase	Intermédiaire	10/01 -> 08/06 08/06 ->	653299		1245	365301673R-93864840 4420800-4408735-91165521 7700313058-3651800QAA
VIVARO all model chassis long/long wheelbase	Intermédiaire	10/01 -> 08/06 08/06 ->	404982		1643	365301796R-4420801- 93864842-8200008473 4408730-91165522 3651800QAC
VIVARO all model chassis cabine/chassis cabs	Intermédiaire	10/01 -> 08/06 08/06 ->	554394		1942	4421104-93864843 4413816-93852378 365309636R-8200316762 8201018831
VIVARO all model	G/L	10/01 -> 08/06 08/06 ->	404983		1503/1365	4414821-93852188 4408734-4411413-91168672 8200263819-8200178389 7700312837
	D/R	10/01 -> 08/06 08/06 ->	404984		1603/1465	4414822-93852189-4408727 4411415-91168673-8200263821 8200178390-7700312836
ZAFIRA						
ZAFIRA (A) all model	Primaire Front	02/99 ->	653298		280	522551-09127937
ZAFIRA (A) all model sauf/except 1.6 16v (freins à tambours/drum brake)	Intermédiaire	02/99 -> 07/05	554365		2x1252/ 1060	522650-09127787
ZAFIRA all model 1.6 16v (freins à tambours/ drum brake)	Intermédiaire	02/99 -> 07/05	653241		2x1355/ 1157	522153-90581267 522558-24436467
ZAFIRA (A) all model (freins à tambours/drum brake)	Liaison G/L or D/R	02/99 ->	653285		182	522653-5226549127527 9127518-52205-18045189
ZAFIRA (A) all model (freins à disques/disc brake)	Unique Single	02/99->Ch. 22006460 02/99->Ch. 1H999999	653242		2x1680/ 1495	522008-522529- 13104993-24465149
ZAFIRA (A) all model (freins à disques/disc brake)	Unique Single	Ch. 22006461-> 3999999 Ch. 2H000001-> 3H99999	554391		2x1677/1495	522032-13153655
ZAFIRA (A) all model (freins à disques/disc brake)	Unique Single	Ch.4000000->07/05 Ch.4H000000->07/05	554392		2x1677/1495	522454-13153656
ZAFIRA II (B) all model (freins à disques/disc brake)	Unique Single	07/05 -> 1774/1577	554393		1749/1551+	522036-522028-522053 522067-13237275-13157064 13321653-13340391
ZAFIRA III (C) all model sans frein électrique/ without electric brake (freins à disques/disc brake)	G/L	11/11 ->	NEW 555088		1890/1760	522099-13367629
	D/R	11/11 ->	NEW 555089		1890/1760	522100-13367630
ZAFIRA III (C) all model (freins à disques/disc brake) avec frein électrique/with electric brake			Not available			522103-13369146

PEUGEOT
104

104 all model (5 portes/doors)	G/L or D/R	01/76 -> 06/88	203000		1420/745	474541-474551
104 coupé (3 portes/doors)	G/L or D/R	01/76 -> 06/88	203010		1230/640	474540-9549561480

106

106 1.0-1.0i-1.1i-1.3i-1.4i-1.6i-1.4D-1.5D (freins à tambours/drum brake)	G/L or D/R	08/91 -> Ch n°51224674	203880	803880	1290/1100	474589-9605885880
106 1.0i-1.1i-1.3i-1.4i-1.6i-1.4D-1.5D (freins à tambours/drum brake)	G/L or D/R	Ch n°51224675 -> 09/03	103780	803780	1443/1120	4745T4-9620911080-4745H7 9620911080-4745J1-9625723180
106 restylé/restyled 1.6i RALLYE & 1.6i 16v (freins à disques/disc brake)	G/L or D/R	07/96 -> 09/03	103840	803840	1510/1230	4745H8-96263856
106 Electrique restylé/Electric restyled	G/L or D/R	07/96 -> 09/03	Not available			4745J1

Véhicule Vehicle	Position	Année Year	SEIM P/n	Kit P/n	Longueur Length	OE
PEUGEOT						
107						
107 all model	G/L	05 ->	204303	804303	1487/1243	4745Y3
	D/R	05 ->	204304		1478/1235	4745Y2
205						
205 all model (freins à tambours/drum brake) sauf /except GTI 130 cv	G/L	02/83 -> 12/98	203660	803660	1372/1085	474555-474563-9151913980
	D/R	02/83 -> 12/98	203670		1387/1100	474556-474564-9151914080
205 1.9 GTI 130 cv freins à disques/disc brake	G/L	02/83 -> 12/98	203840	803850	1420/1180	474567-9153860280
	D/R	02/83 -> 12/98	203850		1430/1180	474568-9153860380
206						
206, 206+ & 206 SW 1.1i-1.4i-1.4i16v-1.6i-1.4HDI 70cv-1.9D-2.0HDI (freins à tambours/drum brake)	G/L or D/R	09/98-> DAM 1150378 (05/08)	204240	804241	1637/1302	4745N4-9628511880 -709086259-
206, 206+ & 206 SW 1.1i-1.4i-1.4i16v-1.6i-1.4HDI 70cv-1.9D-2.0HDI (freins à tambours/drum brake)	G/L or D/R	DAM 1150378 (05/08)->	Not available			474636
206, 206CC, 206, & 206 SW 1.4i16v-1.6i16v-2.0i16v-1.6HDI16v (freins à disques/disc brake)	G/L or D/R	09/98-> DAM 1150378 (05/08)	204250	804251	1710/1430	4745N5-709086258
206, 206CC, 206, & 206 SW 1.4i16v-1.6i16v-2.0i16v-1.6HDI16v (freins à disques/disc brake)	G/L or D/R	DAM 1150378 (05/08)->	Not available			474637
207						
207, 207+ & 207SW 1.4e75cv-1.4i16v90cv-1.4VTi16v95cv-1.4HDI (freins à tambours/drum brake)	G/L or D/R	03/06 ->	204297		1800/950	4745Z3-9650902580
207, 207+, 207CC & 207SW 1.6e16v110cv-1.6VTi16v120cv-1.6THP150 & 156cv-1.6HDI 90, 92 & 110cv (freins à disques/disc brake)	G/L or D/R	03/06 -> OPR 11627 09/08	204298		1900/1120	4745Z4-9650902680
207, 207+, 207CC & 207SW 1.6e16v110cv-1.6VTi16v120cv-1.6THP150 & 156cv-1.6HDI 90, 92 & 110cv (freins à disques/disc brake)	G/L or D/R	OPR 11628 (09/08)->	554669		1910/1105	9802570580-474651 -9684567680
208						
208 1.2 VTi 82cv & 1.4 HDI 68cv (freins à tambours/drum brake)	G/L or D/R	03/12 ->	NEW 555091		1790/916	9671813380
208 1.6VTi16v120cv-1.6HDI 92 & 115cv (freins à disques/disc brake)	G/L or D/R	03/12 ->	554669		1907/1103	9802570580-474651 -9684567680
305						
305 all model	G/L or D/R	07/77 -> 07/82	Not available		1570/890	483467-483471
305 all model 1.3	G/L or D/R	07/82 -> 06/89	203680		1545/876	483480
305 all model 1.6 GL-GLS-GR-SRGT 1.9 GTX & 1.9 GLD-SRD-DGLS	G/L or D/R	07/82 -> 06/84	203690		1676/954	483475
305 all model 1.6 GL-GLS-GR-SRGT 1.9 GTX & 1.9 GLD-SRD-DGLS	G/L or D/R	07/84 -> 06/89	203930		1635/955	483485
306						
306 all model sans/without ABS (freins à tambours/drum brake) sauf/except break/SVW, société/van & cabriolet/convertible	G/L	03/93 -> 03/97	203910	803920	1651/1330	474597-9614790780
	D/R	03/93 -> 03/97	203920		1571/1250	474598-9614790980 -9622434880
306 all model avec/with ABS (freins à tambours/drum brake) sauf/except break/SVW & cabriolet/convertible	G/L	03/93 -> 09/95	203970	803961	1690/1320	4745A4-4745N8-9617667980
	D/R	03/93 -> 09/95	203960		1610/1250	4745A5-9617667780 -9622434980-4745N9
306 all model avec/with ABS (freins à tambours/drum brake) sauf/except break/SVW, société/van & cabriolet/convertible	G/L	10/95 -> 03/02	203910	803920	1656/1330	474597-9614790780
	D/R	10/95 -> 03/02	203920		1571/1250	474598-9614790980
306 break/SVW & société/van all model (freins à tambours/drum brake)	G/L	03/93 -> OPR 08210 (05/99)	203970	803961	1690/1320	4745A4-9404745A48
	D/R	03/93 -> OPR 08210 (05/99)	203960		1610/1260	4745A5-9617667780-

Véhicule Vehicle	Position	Année Year	SEIM P/n	Kit P/n	Longueur Lenght	OE
PEUGEOT						
306 (suite)						
306 break/SW & société/van all model (freins à tambours/drum brake)	G/L	OPR 08211 (05/99)> 03/02	204291	803962	1692/1332	4745N8-9617667980
	D/R	OPR 08211 (05/99)> 03/02	204292		1604/1250	4745N9-9622434980
306 cabriolet/convertible all model sans/ without ABS (freins à tambours/drum brake)	G/L	02/94 -> 03/97	103700	803690	1590/1260	4745F8-9603256580
	D/R	02/94 -> 03/97	103690		1500/1170	4745G1-9603256480
306 cabriolet/convertible all model avec/ with ABS (freins à tambours/drum brake)	G/L	02/94 -> 09/95	103760	554658	1620/1265	4745F7-9614573980
	D/R	02/94 -> 09/95	103750		1530/1180	4745G0-9614574080
306 cabriolet/convertible all model avec/ with ABS (freins à tambours/drum brake)	G/L	10/95 -> 03/02	103700	803690	1590/1260	4745F8-9603256580
	D/R	10/95 -> 03/02	103690		1500/1170	4745G1-9603256480
306 2.0i:2.0 XSI et 2.0i16v (freins à disques/ disc brake) sauf/except cabriolet/convertible	G/L	03/93 -> 03/02	203890	803900	1696/1430	4745A1-9619072480-474599 9614790680
	D/R	03/93 -> 03/02	203900		1615/1350	4745A2-9622435080-4745A0 9619072580
306 cabriolet/convertible 2.0i & 2.0i16v (freins à disques/disc brake)	G/L	02/94 -> 03/02	103710	803720	1620/1340	4745F6-9603256080
	D/R	02/94 -> 03/02	103720		1540/1270	4745F9-9603256180
307						
307 all model sauf/except 307 SW (break) (freins à disques/disc brake)	G/L or D/R	04/01 -> 06/08	204260	804261	2037/1182	474620-9661966980-4745T3 -9636664680
307 SW (break) all model (freins à disques/ disc brake)	G/L or D/R	04/01 -> 06/08	204293	804293	2115/1316	474630-9682784280-4745T9 -9641453080
308						
308 & 308 cabriolet/convertible all model sauf/ except THP 1.6i 16V 200cv mot EP6CDTX & 308 SW (break)	G/L or D/R	09/07 ->	554395	805070	2033/1188	474631-9659391180
308 & 308 cabriolet/convertible THP 1.6i 16V 200cv mot EP6CDTX sauf/except 308 SW (break)	G/L or D/R	09/07 ->	554653		2069/1207	474667-9688480980
308 SW (break) all model	G/L or D/R	09/07 ->	554761			474640-9681881080
309						
309 all model (freins à tambours/drum brake)	G/L	10/85 -> 12/93	203770	803770	1427/1140	474565
	D/R	10/85 -> 12/93	203780		1447/1160	474566-9752240080
309 1.9 GTI & GTI 16v (freins à disques/ disc brake)	G/L	10/85 -> 12/93	203860	803870	1470/1230	474569-9153988180
	D/R	10/85 -> 12/93	203870		1490/1250	474570-9153988280
405						
405 all model sauf/except 4x4	Primaire Front	07/87 -> 10/96	203790		1840/1540	474571-9153946080
405 1.4-1.4i-1.6-1.6i-1.8i-1.9 mot XU92C (carbu)-1.9D-1.8 & 1.9 turbo diesel sauf/ except 4x4 (freins à tambours/drum brake)	G/L	07/87 -> 10/96	203830	803830	849/294	474573-9153946480
	D/R	07/87 -> 10/96	203800		544/294	474574-9153946380
405 1.9i mot XU9J2-2.0i-MI16-1.8 turbo diesel sauf/except 4x4 (freins à disques/disc brake)	G/L	07/87 -> 10/96	203810	803810	872/386	474575-9153946280
	D/R	07/87 -> 10/96	203820		560/385	474576-9153946180
405 1.9i:2.0i-MI16 4x4	Primaire Front	07/87 -> 10/96	202390		1830/1430	474572-9600719580
405 1.9i:2.0i-MI16 4x4 (freins à disques/ disc brake)	G/L	07/87 -> 10/96	204160		840/570	474577-9600702780
	D/R	07/87 -> 10/96	204170		750/570	474578-9600702680
406						
406 all model (réglage par le bas/setting down)	Primaire Front	10/95 -> OPR 8210 (04/99)	202361		1728/1413	4745L4-9631657480 4745H0-9616426480 4745L3-9631657580 4745H9-9625818780
406 all model (réglage par le haut/setting up)	Primaire Front	OPR 8211 (05/99)> OPR 8574 (04/00)	202371		1610/1406	4745P2-9632426480 -4745P1-9632426180
406 all model (réglage par le haut/setting up)	Primaire Front	OPR 8575 (05/00)> 04/04	202373		1656/1310	4745R7-9638509080 -4745R8-9638508580

Véhicule Vehicle	Position	Année Year	SEIM P/n	Kit P/n	Longueur Lenght	OE
PEUGEOT						
<i>Suite...</i>						
406 (suite)						
406 1.6i-1.8i-1.9 TurboD (freins à tambours/ drum brake)	G/L	10/95 -> OPR 8511 (03/00)	204020	804010	824/545	4745H1-9623328980
	D/R	10/95 -> OPR 8511 (03/00)	204010		750/550	4745L5-9630504580- 4745H2-9623329080
406 1.6i-1.8i-1.9 TurboD (freins à tambours/ drum brake)	G/L	OPR 8512 (04/00)> 04/04	204270	804270	830/550	4745R1-9638603880
	D/R	OPR 8512 (04/00)> 04/04	204180		750/545	4745R2-9638603980
406 1.816v-2.0i-2.016v-2.0 HPi-2.0 Turbo- 3.0i V6-2.1 TurboD-2.0HDI 90 & 110cv-2.2HDI sauf/except coupé (freins à disques/disc brake)	G/L	10/95 -> 04/04	204040	804190	690/490	4745H3-9616427180
	D/R	10/95 -> 04/04	204190		645/500	4745L6-9630504380-4745H4 -9616427580
406 Coupé 2.0i16v-2.2i16v-3.0i V6 & 2.2HDI (freins à disques/disc brake)	G/L	10/95 -> 12/04	204200	804810	710/510	4745J6-9627221880
	D/R	10/95 -> 12/04	204210		640/510	4745J7-9627221980
407						
407 & 407 SW (break) all model	G/L or D/R	04/04->	204300	804300	2164/1330	4745X4-9644602880
504						
504 all model	Primaire Front		Not available			
504 GL GLD TI sauf/except break/SW (freins à disques/disc brake)	G/L or D/R	09/68 -> 09/76	203310		1647/1065	483452-7910019217
504 L LD GR GRD SR SRD avec sieges avant/ with front seats sauf/except break/SW	G/L or D/R	07/72 -> 10/83	203320		1665/1454	483458-9153857580
504 break/SW avec sieges avant/with front seats	G/L or D/R	07/72 ->	203420		1740/1525	483457-7910013472
504 pick up all model	G/L	09/68 -> 10/83	203460		1470/1060	483470-9151665480
	D/R	09/68 -> 10/83	203450		1306/1100	483469-9151665380
505						
505 all model sauf/except break/SW (freins à tambours/drum brake)	G/L or D/R	07/79 -> 92	203480		1590/940	483472
505 all model sauf/except break/SW (freins à disques/disc brake)	G/L or D/R	07/79 -> 92	203730		1640/1065	483473
505 break & familiale/SW sauf banquettes avant/except front bench seats	G/L or D/R	07/79 -> 92	203740		1785/1040	483477
508						
508 all model sauf/except 2.0 HDI 163cv Hybride	G/L or D/R	01/11 ->	NEW 555094		2238/1400	474681-9899992480
508 2.0 HDI 163cv Hybride	G/L or D/R	01/11 -> OPR 12928 (04/12)	Not available			1608756280
508 2.0 HDI 163cv Hybride	G/L or D/R	OPR 12929 (04/12)>	NEW 555093			9803754780
605						
605 all model	Primaire Front	09/89 -> 07/99	202360		390	474581-9625432480
605 all model	Intermediate	09/89 -> 07/99	202350		1640/1500	474582-9625432280
605 all model	G/L	09/89 -> Serial n° S90879392	203940	803950	745/385	474583-9606161780
	D/R	09/89 -> Serial n° S90879392	203950		635/385	474584
605 all model	G/L	Serial n°S90879393 -> 07/99	203980	803990	745/385	4745F0-9618796480
	D/R	Serial n°S90879393 -> 07/99	203990		640/390	4745F1-9618796380
607						
607 all model	Primaire Front	11/99 ->	202374		2145/1675	4745W2-9648906780- 4745P7-4745X5-9651265680
607 all model (freins à disques/disc brake)	G/L	11/99 -> 09/04	204280	804280	720/390	4745P8-9633590580
	D/R	11/99 -> 09/04	204281		720/390	4745P9-9633590680
607 II all model (freins à disques/disc brake)	G/L	09/04 ->	204301	804301	820/480	4745X6-9651271080
	D/R	09/04 ->	204302		800/480	4745X7-9651270380

Véhicule Vehicle	Position	Année Year	SEIM P/n	Kit P/n	Longueur Lenght	OE
PEUGEOT						
806						
806 all model	Primaire Front	07/94 -> 09/02	102440		500/305	474626-1400813180-4745E9 1472957080-4745T5-1487276080
806 all model sauf/except 1.8i:2.0i:2.0i16v:2.0i Turbo (freins à tambours/drum brake)	G/L	07/94 -> 09/02	204060	804050	989/770	4745F2-1473322080-4745G9
	D/R	07/94 -> 09/02	204050		2280/2060	4745F3-1473321080
806 1.8i:2.0i:2.0i16v:2.0i Turbo (freins à disques/disc brake)	G/L	07/94 -> 09/02	204070	804070	1250/1060	4745F4-1472959080
	D/R	07/94 -> 09/02	204080		2220/2070	4745F5-1472958080
807						
807 all model	Primaire Front	06/02 -> 01/05	102440		500/305	474626-1400813180-4745E9 1472957080-4745T5-1487276080
807 all model avec silencieux AR longitudinal/ with longitudinal rear silencer (freins à disques/ disc brake)	G/L	06/02-> OPR 10284 (01/05)	104090	804081	1068/840	4745T6-1487274080
	D/R	06/02-> OPR 10284 (01/05)	104080		2360/2220	4745T8-4745T7-1487647080 -1487275080
807 all model	Primaire Front	02/05-> OPR 11682 (11/08)	NEW 555212			474623
807 all model	Primaire Front	OPR 11683 (11/08)->	NEW 554905			474652-1401441780
807 all model avec silencieux AR longitudinal/ with longitudinal rear silencer (freins à disques/ disc brake)	G/L	OPR 10285 (02/05)-> 12/06	554050	805021	1041/840	474619-4745Y8-1400310380
	D/R	OPR 10285 (02/05)-> 12/06	554051		2308/2151	4745Y6-4745Y7-1400310280 -1400310180
807 all model avec silencieux AR transversal/ with transversal rear silencer (freins à disques/ disc brake)	G/L or D/R	01/06 ->	554108	805037	1257/1115	474609-1400204180
1007						
1007 1.4i:1.4i16v:1.4HDI (freins à tambours/ drum brake)	G/L or D/R	04/05 ->	104100	804100	1612/800	474615-4745W3-9648084880
1007 1.6i16v & 1.6 HDI 16v (freins à disques/ disc brake)	G/L or D/R	04/05 ->	104110	804111	1700/935	474616-4745W4-9639346180
2008						
2008 1.2 Vti 82cv-1.6 VTI 120cv-1.4 HDI 68cv-1.6HDI 92 & 115cv (freins à disques/disc brake)	G/L or D/R	05/13->	554669		1910/1105	9802570580-474651 -9684567680
3008						
3008 all model sauf/except 2.0 HDI 163cv Hybride	Primaire Front	04/09 ->	Not available			474669
3008 1.6VTi16v120cv-1.6THP150 & 156cv-1.6HDI 110 & 112cv-2.0 HDI 150 & 163cv avec frein électrique/with electric brake sauf/ except 2.0 HDI 163cv Hybride	G/L or D/R	04/09 ->	554673		829/666	474677-474657-474670-474656
3008 2.0 HDI 163cv Hybride	G/L or D/R	10/11 ->	NEW 555092			9801531080
4007						
4007 all model	G/L	07/07 au	554053	805023		474632-4820A104
	D/R	07/07 au	554054		474633-4820A103	
5008						
5008 all model	Primaire Front	11/09 ->	Not available			474666
5008 all model	G/L	11/09 ->	554676			474679-474664-9672955480 9675503880
	D/R	11/09 ->	554677			474678-474665-9672955380 9675501780
BIPPER						
BIPPER 1.4i	G/L	10/07 ->	554067		1662/1407	474642-51784535
	D/R	10/07 ->	554068		1695/1442	474643-51784533
BIPPER 1.4 HDI	G/L	10/07 ->	554069		1610/1402	474644-51784536
	D/R	10/07 ->	554070		1710/1435	474645-51784534

Véhicule Vehicle	Position	Année Year	SEIM P/n	Kit P/n	Longueur Lenght	OE
PEUGEOT						
<i>Suite...</i>						
BOXER						
BOXER all model	Primaire Front	02/94->SERIE 16194399	202440		1059/761	4745G2-1308638080
BOXER all model	Primaire Front	SERIE 16194400->02/02	202470		1078/762	4745V6-1336889080
BOXER all model avec/with normal suspension sauf/except camping car	Unique Single	02/94-> SERIE 16158427	103770		3027/800x2	4745G3-1307963080
BOXER all model avec/with normal suspension sauf/except camping car	Unique Single	SERIE 16158428 ->16194399	204294		2810/860x2	4745V2-1330058080
BOXER all model avec/with normal suspension sauf/except camping car (freins à tambours/drum brake)	Unique Single	SERIE 16194400->02/02	204295		2827/876x876	4745V5-1337440080
BOXER all model (freins à disques/disc brake)	Unique Single	SERIE 16194400->02/02	204296		2715/890x2	4745V4-4745V5-1339676080-1339394080
BOXER camping car BOXER avec/with reinforced suspension BOXER équipé piste/off road equipment	Unique Single	02/94-> SERIE 16158427	103990		3040/810x2	4745G7-1314983080-4745X1
BOXER camping car BOXER avec/with reinforced suspension BOXER équipé piste/off road equipment	Unique Single	SERIE 16158428->02/02	554056		2827/875x2	4745V3-1330066080
BOXER 4x4 DANGEL	Primaire Front	02/94->02/02	202470		1078/762	4745V6-1336889080
BOXER 4x4 DANGEL avec empattement court & moyen/with short & medium wheelbase sauf/except BV MLGU/GB MLGU (freins à tambours/drum brake)	Unique Single	02/94->02/02	103770		3027/800x2	4745G3-1307963080
BOXER 4x4 DANGEL avec empattement court & moyen/with short & medium wheelbase avec BV MLGU/with GB MLGU (freins à tambours/drum brake)	Unique Single	02/94->02/02	204294		2810/860x860	4745V2-1330058080
BOXER 4x4 DANGEL avec empattement long/with long wheelbase (freins à tambours/drum brake)	Unique Single	02/94->02/02	104000		4100/1410x1410	4745J2
BOXER 4x4 DANGEL avec empattement court/with short wheelbase simple lame/single blade REP 13 300 580 80 (freins à disques/disc brake)	Unique Single	02/94->02/02	204295		2827/876x876	4745V5-1337440080
BOXER 4x4 DANGEL avec empattement court/with short wheelbase double lame/double blade REP 13 300 660 80 & avec empattement moyen/with medium wheelbase simple lame/simple blade REP 13 079 630 80 (freins à disques/disc brake)	Unique Single	02/94->02/02	103770		3027/800x2	4745G3-1307963080
BOXER 4x4 DANGEL avec empattement moyen/with medium wheelbase double lame/double blade REP 13 149 830 80 (freins à disques/disc brake)	Unique Single	02/94->02/02	103990		3040/810x2	4745G7-1314983080-4745X1
BOXER 4x4 DANGEL avec empattement long/with long wheelbase (freins à disques/disc brake)	Unique Single	02/94->02/02	104000		4100/1410x1410	4745J2
BOXER II						
BOXER II VIN = VF3 sauf/except 4x4	Primaire Front	02/02->06/06	202470		1078/762	4745V6-1336889080
BOXER II VIN = 936 sauf/except 4x4	Primaire Front	02/02->06/06	Not available		343	1609089780
BOXER II VIN = 936 sauf/except 4x4	Primaire Front	02/02->06/06	Not available		693	1609089580
BOXER II VIN = 936 sauf/except 4x4	Primaire Front	02/02->06/06	Not available		1200	1609089980
BOXER II 4x4	Primaire Front	02/02->06/06	202440		1059/761	4745G2-1308638080
BOXER II (freins à tambours/drum brake) sauf/except 4x4	Unique Single	02/02->06/06	204295		2827/876x876	4745V5-1337440080
BOXER II (freins à disques/disc brake)	Unique Single	02/02->SERIE 17103012	204296		2715/890x2	4745V4-4745V5-1339676080-1339394080

Véhicule Vehicle	Position	Année Year	SEIM P/n	Kit P/n	Longueur Lenght	OE
PEUGEOT						
BOXER II (suite)						
BOXER II (freins à disques/disc brake)	Unique Single	SERIE 17103013 ->06/06	204296		2715/890x2	4745V4-4745W5-1339676080 -1339394080
BOXER II GPL & GNV	Primaire Front	02/02->06/06	554057		1463/645	4745W6-1338683080
BOXER II GPL & GNV (freins à disques/disc brake)	G/L or D/R	02/02->06/06	554058		955/782	4745W7-1338691080
BOXER III						
BOXER III Fourgon/Van BOXER III Chassis cabine court/short chassis cabs	Primaire Front	06/06-> SERIE 11175965	554059		1908/1596	4745Z9-474647-1341023080 -1359245080
BOXER III Chassis moyen long & pavillon standard sauf chassis spécial /with medium long wheelbase & standard roof panel except spécial chassis	Primaire Front	06/06-> SERIE 11175965	554061		2648/2335	474629-1350314080 -474650-1359247080
BOXER III Chassis cabine/chassis cabs BOXER III Chassis double cabine moyen/ Medium chassis with twincabs BOXER III Chassis double cabine long/ Long chassis with twin cabs	Primaire Front	06/06-> SERIE 11175965	554060		2296/1981	474627-1350313080
BOXER III Chassis cabine long/ with long chassis cabs BOXER III Chassis double cabine rallongé/ chassis with stretched twin cabs	Primaire Front	06/06-> SERIE 11175965	554063		2910/2598	474628-1350315080 474649-1359248080
BOXER III Fourgon/van BOXER III Chassis Cabine court/ with short chassis cabs BOXER III Chassis double cabine moyen/ medium chassis with twincabs	Primaire Front	SERIE 11175966 ->	554059		1908/1596	4745Z9-474647- 1341023080-1359245080
BOXER III Chassis Cabine moyen/ with medium chassis cabs	Primaire Front	SERIE 11175966->	554060		2296/1981	474627-1350313080 -474648-1359246080
BOXER III Chassis Cabine long/long chassis cabs BOXER III Chassis Cabine rallongé/ stretched chassis cabs BOXER III Chassis double cabine rallongé/ stretched chassis cabs	Primaire Front	SERIE 11175966 ->	554063		2910/2598	474628-1350315080 -474649-1359248080
BOXER III Chassis moyen long & pavillon standard sauf châssis spécial /medium long chassis & standard roof panel except special chassis	Primaire Front	SERIE 11175966->	554061		2648/2335	474629-1350314080 474650-1359247080
BOXER III sauf voie arrière élargie/ except rear track extended	G/L or D/R	06/06->	554062		1390/1075	474617-1341031080
BOXER III avec voie arrière élargie/ with rear track extended	G/L or D/R	06/06->	554064		1485/1168	474618-1348980080
EXPERT & TEPEE						
EXPERT I all model	Primaire Front	08/95 -> 12/06	102440		500/305	474626-1400813180-4745E9 1472957080-4745T5-1487276080
EXPERT I all model châssis long/long chassis	Primaire Front	08/95 -> 12/06	102430		900/650	474624-1400813280 -4745P0-1484375080
EXPERT I all model (freins à tambours/drum brake)	G/L	08/95 -> 12/06	204060	804050	989/770	4745F2-1473322080-4745G9
	D/R	08/95 -> 12/06	204050		2290/2060	4745F3-1473321080
EXPERT II & TEPEE II						
EXPERT II & EXPERT TEPEE all model	Primaire Front	01/07 -> OPR 11682	NEW 555212		1494/1274	474623-474672-1440125280
EXPERT II & EXPERT TEPEE all model	Primaire Front	OPR 11683->	NEW 554905			474652-1401441780
EXPERT II & EXPERT TEPEE all model (freins à tambours/drum brake)	G/L or D/R	01/07 -> OPR 11986	554655	805125	1494/1274	474610-1400203780
EXPERT II & EXPERT TEPEE all model (freins à tambours/drum brake)	G/L or D/R	OPR 11987->	554655	805125	1494/1274	474672-1440125280-474623

Véhicule Vehicle	Position	Année Year	SEIM P/n	Kit P/n	Longueur Lenght	OE
PEUGEOT Suite...						
EXPERT II & TEPEE II (suite)						
EXPERT II & EXPERT TEPEE 2.0 16v-1.6 HDI-2.0HDI 120-143 & 163cv (freins à disques/disc brake)	G/L or D/R	01/07-> OPR 13601 (02/14)	554052	805022	1613/1467	474611-1401352380 -1400203680
EXPERT II & EXPERT TEPEE 2.0 16v-1.6 HDI-2.0HDI 120-143 & 163cv (freins à disques/disc brake)	G/L or D/R	OPR 13601 (02/14)>	Not available			9809533480
EXPERT II & EXPERT TEPEE all model avec châssis long/with long chassis (freins à disques/disc brake)	G/L or D/R	01/07-> OPR 13601 (02/14)	554065	805027	1737/1591	474612-1400204880
EXPERT II & EXPERT TEPEE all model avec châssis long/with long chassis wheel (freins à disques/disc brake)	G/L or D/R	OPR 13601 (02/14)>	Not available			9809533580
J5						
J5 all model Châssis normal/normal chassis	Primaire Front	09/81->06/94	102420		1610/1410	474552
J5 all model Châssis rallongé/extended chassis	Primaire Front	09/81->06/94	102400		2340/2140	474554
J5 all model sauf/except 4x4 & 800 Kg	Unique Single	09/81->06/94	203750		2570/700x2	483476
J5 all model 4X4 sauf/except 800 Kg	Unique Single	09/81->06/94	204290		2600/730x 730	474596
J5 all model 800 Kg sauf châssis cabine/except chassis cabs	Primaire Front	09/81->06/94	Not available		1660/1540	474579
J5 châssis cabine/chassis cabs 800 Kg	Primaire Front	09/81->06/94	102390		2540/2410	4745A3-7660110
J5 all model 800 Kg	Unique Single	09/81->06/94	103960		2260/990x 1010	474580-ZF07641374
J7 & J9						
J7 & J9 all model	G/L	08/73->91	203640		930/725	483228
	D/R	08/73->91	203650		1340/1135	483229-7901483229
PARTNER						
PARTNER (M49) all model (freins à tambours/drum brake)	G/L	01/97>OPR 08393 (10/99)	103800	803800	1750/1410	4745X8-4745J0-9622250380
	D/R	01/97>OPR 08393 (10/99)	103810		1810/1480	4745J3-9627711980
PARTNER (M49/M59) all model sauf/except ESP (freins à tambours/drum brake)	G/L	OPR 08394 (11/99)>05/08	103800	804041	1750/1410	4745X8-4745J0-9622250380
	D/R	OPR 08394 (11/99)>05/08	104041		1850/1510	4745X9-4745R0-9639179280
PARTNER (M59) avec/with ESP (freins à disques/disc brake)	G/L	11/02->05/08	554042	805015	1820/1555	4745Y0-4745X2
	D/R	11/02->05/08	554043		1922/1640	4745Y1
PARTNER III (B9) all model	G/L or D/R	06/08->	554044	805016	2402/1300	474646
RCZ						
RCZ all model	G/L or D/R	01-2010>	NEW 555095			474668-9687803980

PORSCHE

CAYENNE

CAYENNE	G/L or D/R	11/02->04/10	554528	805122	1750/1631	7L0609721A-95542414110
---------	------------	--------------	--------	--------	-----------	------------------------

RENAULT

CAPTUR

CAPTUR 0.9 TCE 90cv-1.2 TCE 120cv & 1.5 DCI 90cv (freins à tambours/drum brake)	G/L	02-2013>	NEW 555181			365315806R
	D/R	02-2013>	NEW 555182			365308900R

CLIO I

CLIO 1.1-1.2-1.2i-1.4-1.4i-1.7i-1.8i-1.9D (freins à tambours/drum brake)	G/L or D/R	06/90->02/98	404240	804240	1430/1100	7700802685
CLIO 1.8i-1.8 RSi-2.0i16v-16S & WILLIAMS (freins à disques/disc brake)	G/L or D/R	06/90->02/98	404250	804250	1480/1190	7700802686

Véhicule Vehicle	Position	Année Year	SEIM P/n	Kit P/n	Longueur Lenght	OE
RENAULT						
<i>Suite...</i>						
CLIO II & CLIO CAMPUS						
CLIO II 1.2i-1.4i-1.9D avec/with ABS (freins à tambours/drum brake)	G/L	02/98 -> 07/00	404800	804800	1277/1000	7700426006
	D/R	02/98 -> 07/00	404810		1360/1090	7700426005
CLIO II 1.2i-1.4i-1.9D sans/without ABS (freins à tambours/drum brake)	G/L	02/98 -> 07/00	404820	804820	1265/1000	7700424928
	D/R	02/98 -> 07/00	404830		1345/1080	7700424926
CLIO II 1.2 16V sans/without ABS (freins à tambours/drum brake)	G/L	08/00 ->	404871	804870	1323/1000	8200087982
	D/R	08/00 ->	404870		1400/1090	8200087981
CLIO II & CAMPUS 1.2i-1.2 GPL-1.4i-1.4i16v- 1.6 16v-1.9D-1.9dTi-1.5 dCi 65, 70, 80 & 85cv sans/without ESP avec ou sans/with or without ABS (freins à tambours/drum brake)	G/L	08/00 ->12/12	404881	804880	1340/1000	8200700184-8200087979 7700433238
	D/R	08/00 ->12/12	404880		1420/1090	8200700132 8200087977 7700433237
CLIO II & CAMPUS 1.4i16v-1.6 16v 1.5 dCi 80cv avec/with ESP & ABS (freins à disques/disc brake)	G/L	06/01 ->	554398	805072	1381/1100	8200228347
	D/R	06/01 ->	554399		1448/1170	8200228260
CLIO II 2.0 16v (freins à disques/disc brake)	G/L	02/98 -> 09/00	404860	804860	1310/1100	6000073540
	D/R	02/98 -> 09/00	404861		1380/1170	6000073539
CLIO II 2.0 16v (freins à disques/disc brake)	G/L	09/00 -> 09/05	554678		1365/1101	6000073733
	D/R	09/00 -> 09/05	554679		1435/1140	6000073734
CLIO III						
CLIO III & CLIO III ESTATE 1.2i 16V-1.2 16v TCE 1.2 GPL-1.4 16v-1.6 16v-2.0 16v 140cv 1.5 dCi 70, 85 & 105cv sans jante alu ø16/ without ø16 alu rim & sans/without ESP	G/L	09/05 ->	404652	804651	1450/1300	8200673252-8200298384
	D/R	09/05 ->	404651		1590/1430	8200673254-8200298383
CLIO III & CLIO III ESTATE 1.2i 16V-1.2 16v TCE 1.4 16v-1.5 dCi 70 & 85cv avec jante alu ø16/ with ø16 alu rim & sans/without ESP (freins à tambours/drum brake)	G/L	09/05 ->	NEW 555096		1440/1283	8200577939
	D/R	09/05 ->	NEW 555097		1572/1415	8200577938
CLIO III & CLIO III ESTATE 1.2i 16V-1.2 16v TCE 1.4 16v-1.6 16v-2.0 16v 140cv-1.5 dCi 70, 85 & 105cv avec/with ESP (freins à disques/ disc brake)	G/L	09/05 ->	404654	804653	1330/1210	8200673258-8200270182
	D/R	09/05 ->	404653		1450/1330	8200673259-8200270181
CLIO III 2.0 16V SPORT 200cv (freins à disques/disc brake)	G/L	09/05 -> 12/06	404652	804651	1450/1300	8200673252-8200298384
	D/R	09/05 -> 12/06	404651		1590/1430	8200673254-8200298383
CLIO III 2.0 16V SPORT 200-203cv (freins à disques/disc brake)	G/L	12/06 ->	554680		1596/1498	8200662793-8200440514
	D/R	12/06 ->	554681		1458/1362	8200662794-8200440525
CLIO IV						
CLIO IV 0.9 TCE 90cv-1.2i 16v 75cv 1.5 dCi 75 & 90cv sauf/except ESTATE (freins à tambours/drum brake)	G/L	07/12->	NEW 555102			365311282R
	D/R	07/12->	NEW 555103			365302756R
CLIO IV 1.6 Turbo 200cv RS (freins à disques/disc brake)	G/L	07/12->	NEW 555100			365307515R
	D/R	07/12->	NEW 555101			365318024R
CLIO IV ESTATE 0.9 TCE 90cv-1.2i 16v 75cv 1.5 dCi 75 & 90cv (freins à tambours/drum brake)	G/L	10/12->	NEW 555098			365317404R
	D/R	10/12->	NEW 555099			365304960R
ESPACE I						
ESPACE GTS TSE TXE 2000-1 (freins à tambours/drum brake)	G/L	07/84 ->Ch.5829	404080	804110	1890/820	6025000831
	D/R	07/84 ->Ch.5829	404110		1160/820	6025000832
ESPACE GTS TSE TXE 2000-1 2001-1D TURBO D & DX (freins à tambours/drum brake)	G/L	Ch.5830 -> 04/91	404100	804090	1980/820	6025002628-Kit 6025171471
	D/R	Ch.5830 -> 04/91	404090		1040/820	6025002627-Kit 6025171471
ESPACE all model avec/with ABS (freins à disques/disc brake)	G/L	07/84 -> 03/91	404600		1310/1020	6025007115
	D/R	07/84 -> 03/91	404610		1920/1020	6025007116
ESPACE all model QUADRA (4X4)	G/L	07/84 -> 03/91	404620		1060/760	6025006423
	D/R	07/84 -> 03/91	404630		1682/760	6025006424
ESPACE II						
ESPACE II 2.2i & 2.1dT (freins à tambours/drum brake)	G/L	04/91 -> 06/97	404100	804090	1980/820	6025002628-Kit 6025171471
	D/R	04/91 -> 06/97	404090		1045/820	6025002627-Kit 6025171471
ESPACE II all model sans/without ABS (freins à disques/disc brake)	G/L	04/91 -> 06/97	404640	804640	1287/997	6025105919
	D/R	04/91 -> 06/97	404650		1909/997	6025105918

Véhicule Vehicle	Position	Année Year	SEIM P/n	Kit P/n	Longueur Lenght	OE
RENAULT						
<i>Suite...</i>						
ESPACE II (suite)						
ESPACE II all model avec/with ABS (freins à disques/ disc brake) sans/without correcteur d'assiette	G/L	04/91 -> 06/97	404650	804640	1890/1010	6025105918
	D/R	04/91 -> 06/97	404640		1290/1070	6025105919
ESPACE II all model QUADRA (4X4)	G/L	04/91 -> 06/97	404620		1060/760	6025006423
	D/R	04/91 -> 09/97	404630		1682/760	6025006424
ESPACE III						
ESPACE III court 2.0-2.2 dT (freins à tambours/drum brake)	Kit G/L + D/R	12/96 -> 09/02	404740	Kit de 2 câbles	1580/1520 +1370/1310	6025370468 - (6025313181+ 6025313182)
ESPACE III court 2.0 16V & 3.0 V6 (freins à disques/disc brake)	Kit G/L + D/R	12/96 -> 09/02	404750	Kit de 2 câbles	1630/1570+ 1490/1430	6025370467 - (6025304630+ 6025304631)
ESPACE III empattement/wheelbase 27.02 Mot. 2.0 16V 3.0 V6 & 2.2 Dci (freins à disques/disc brake)	Kit G/L + D/R	12/96 -> 09/02	404902	Kit de 2 câbles	1700/1550+ 1643/1493	6025371373 (602541079DD+602541078DG)
ESPACE III GRAND 2.0i & 2.2dT (freins à tambours/drum brake)	Kit G/L + D/R	01/98 -> 09/02	404890	Kit de 2 câbles	1740/1680+ 1540/1470	6025370827
ESPACE III GRAND empattement/wheel base 28.74 2.2 dCi 115 & 130cv (freins à disques/disc brake)	Kit G/L + D/R	01/98 -> 09/02	404901	Kit de 2 câbles	1850/1790+ 1800/1710	6025371283 (6025410680+6025410681) 6025371397
ESPACE III GRAND empattement/wheel base 28.74 2.0 16V-3.0 V6 (freins à disques/ disc brake)	Kit G/L + D/R	01/98 -> 01/00	404901	Kit de 2 câbles	1850/1790+ 1800/1710	6025371283 (6025410680+6025410681) 6025371397
ESPACE III GRAND empattement/wheel base 28.74 2.0 16V-3.0 V6 (freins à disques/ disc brake)	Kit G/L + D/R	01/00 -> 09/02	404900	Kit de 2 câbles	1800/1720+ 1700/1590	6025370922
ESPACE IV						
ESPACE IV avec frein automatique/ with automatic brake (Seulement /only cable)			Not available			8200418646
EXPRESS						
EXPRESS all model	G/L or D/R	09/84 -> 07/91	403140	803140	1330/1110	7700754882
EXPRESS all model sauf/except charge utile/ payload 775Kg	G/L or D/R	07/91 -> 12/96	404550	804450	1470/1100	6006000595
EXPRESS all model charge utile/payload 775Kg	G/L or D/R	07/91 -> 12/96	404560	804560	1470/1080	6006000596
KANGOO & KANGOO EXPRESS						
KANGOO I & EXPRESS all model sauf/ except 4x4 charge utile/payload jusqu'à/up to 600Kg (freins à tambours/drum brake)	G/L	09/97 -> 12/07	404760	804760	1423/1060	8200694053-7700311698 7700301342
	D/R	09/97 -> 12/07	404770		1420/1080	8200694056-7700311699 7700309270
KANGOO EXPRESS all model charge utile/payload jusqu'à/up to 800Kg (freins à tambours/drum brake)	G/L	09/97 -> 12/07	404780	804780	1438/1050	8200694080-7700311700
	D/R	09/97 -> 12/07	404790		1442/1060	8200694083-7700311701
KANGOO I & EXPRESS all model 4x4 charge utile/payload jusqu'à/up to 600Kg (freins à tambours/drum brake)	G/L	09/97 -> 12/07	404760	804760	1423/1060	8200694053-7700311698 7700301342
	D/R	09/97 -> 12/07	404770		1420/1080	8200694056-7700311699 7700309270
KANGOO I & EXPRESS all model 4x4 (freins à disques/disc brake)	G/L or D/R	09/97 -> 12/07	405300		1524/1237	8200694016-8200694022 8200042064-8200042065
KANGOO II EXPRESS 3 portes/doors 1.6 & 1.5 DCI 70-85cv (freins à tambours/drum brake)	G/L or D/R	10/08 ->	554767		1970/776	8200935172
KANGOO II & EXPRESS 1.6-1.6 16v & 1.5 DCI 70-85-105cv sauf/except BE BOP (freins à disques/disc brake)	G/L or D/R	10/08 ->	554401	805074	2015/920	8200526870
KANGOO II BE BOP 1.6 16V & 1.5 DCI 105cv (freins à disques/disc brake)	G/L or D/R	01/08 ->	554400	805073	1760/920	8200577789
KOLEOS						
KOLEOS 2.5i 16V & 2.0 DCI 150 cv sauf frein automatique/except automatic brake	Primaire Front	06/08 ->	NEW 555078		262	36402JD00A

Véhicule Vehicle	Position	Année Year	SEIM P/n	Kit P/n	Longueur Length	OE
RENAULT						
<i>Suite...</i>						
KOLEOS (suite)						
KOLEOS 2.5i 16V & 2.0 DCI 150 cv sauf frein automatique/except automatic brake	G/L	06/08 ->	554402	805065	1760/1580	36531JY00A
	D/R	06/08 ->	554403		1760/1577	36530JY00A
KOLEOS 2.0 DCI 150 & 175cv & 2.5i 16V avec frein automatique/with automatic brake	G/L	06/08 ->	Not available			36531JY50A
	D/R	06/08 ->	Not available			36530JY50A
LAGUNA						
LAGUNA I 1.8 1.8 16v 2.0 2.0 16v 1.9 dTi & 2.2d (freins à tambours/drum brake)	G/L or D/R	01/94 -> 11/00	404530	804530	1160/921	7700823689
LAGUNA I Break 1.8 1.8 16v 2.0 2.0 16v 1.9 dTi & 2.2d (freins à tambours/drum brake)	G/L or D/R	07/95 -> 11/00	404730	804730	1160/900	7700841026
LAGUNA 2.0S V6 & 2.2dT (freins à disques/disc brake)	G/L or D/R	01/94 -> 04/98	404540	804540	1246/1050	7700823690
LAGUNA 1.8 16V 2.0 16v V6 24v & 2.2dT (freins à disques/disc brake)	G/L or D/R	05/98 -> 11/00	404720	804720	1184/988	7700422532
LAGUNA II & LAGUNA ESTATE all model (freins à disques/disc brake)	G/L or D/R	11/00 -> 09/07	404910	804910	2220/1230	8200694119-8200253905 8200002236
LAGUNA III LAGUNA III COUPE & LAGUNA III ESTATE 1.6 16v-2.0 16v-1.5 dCi 110cv 2.0 dCi 130 & 150cv	G/L or D/R	10/07 ->	554405	805077	2240/1295	365300001N
LAGUNA III & LAGUNA III ESTATE all model avec frein automatique/with automatic brake	G/L or D/R	10/07 ->	554404	805076	1883/1062	364000001R
MASTER						
MASTER Propulsion AR avec empattement/rear wheel drive with wheelbase 3,2 m	Primaire Front	09/80 -> 09/97	402950		2500/1875	5000388521-7701035875
MASTER Propulsion AR avec empattement/ear wheel drive with wheelbase 3,8 m	Primaire Front	09/80 -> 09/97	402960		3165/1880	5000388522-7701035876
MASTER all model Propulsion AR/rear wheel drive (freins à tambours/drum brake)	G/L or D/R	09/80 -> 12/81	404440		1795/985	5000388538
MASTER all model Propulsion AR (freins à tambours/drum brake)	G/L or D/R	01/82 -> 09/97	404440		1780/950	5000395883
MASTER all model traction AV/front wheel drive avec empattement/with wheelbase 3,2m	Primaire Front	09/80 -> 12/81	Not available		2695/1310	500387617
MASTER all model traction AV/front wheel drive avec empattement/with wheelbase 3.2m	Primaire Front	01/82 -> 09/92	Not available		2610/1260	5000395884
MASTER Traction AV/front wheel drive avec empattement/with wheelbase 3,2m	Primaire Front	10/92 -> 11/95	402480		2980/2570	6006001013
MASTER Traction AV/front wheel drive avec empattement/with wheelbase 3,2m	Primaire Front	12/95 -> 09/97	402971		3000/2570	7700302782
MASTER all model traction AV/front wheel drive avec empattement/with wheelbase 3.8m	Primaire Front	09/80 -> 12/81	Not available		3260/1300	500388497-5000388438
MASTER all model traction AV/front wheel drive avec empattements/with wheelbase 3,8m	Primaire Front	01/82 -> 09/92	Not available		3274/1260	5000395885
MASTER Traction AV/front wheel drive avec empattement/with wheelbase 3,8m	Primaire Front	10/92 -> 11/95	402970		3620/2570	6006001010
MASTER Traction AV/front wheel drive avec empattement/with wheelbase 3,8m	Primaire Front	12/95 -> 09/97	402972		3630/2570	7700302783
MASTER all model traction AV/front wheel drive	G/L or D/R	09/80 -> 12/81	404060		1765/965	5000387975-5000389550
MASTER all model traction AV/front wheel drive	G/L or D/R	01/82 -> 09/97	404430		1750/920	5000395882
MASTER II						
MASTER II all model	Primaire Front	10/97 -> 04/10	404977		1175/946	8200694124-8200021935 7700311216
MASTER II all model 2800-3300 & 3500 2.5dCi 100-120-150cv (freins à tambours/drum brake)	G/L or D/R	10/97 -> 04/10	404975		1420/1048	7700311217
MASTER II all model 2800-3300 & 3500 2.5dCi 100-120-150cv (freins à disques/disc brake)	G/L or D/R	10/97 -> 04/10	404976		1737/1439	8200694128-8200021940 8200021940R-3640000GAB 3640000G0C

Véhicule Vehicle	Position	Année Year	SEIM P/n	Kit P/n	Longueur Lenght	OE
RENAULT						
<i>Suite...</i>						
MASTER III						
MASTER III 2800 all model	Primaire Front	04/10>	NEW 555104			364028595R
MASTER III 2800 Traction AV/Front wheel drive 2.3 dCi 100-125-150cv	G/L or D/R	04/10>	NEW 555108			364007808R
MASTER III 3300-3500 all model	Primaire Front	04/10>	NEW 555105			364024124R
MASTER III 3300-3500 L1 Traction AV/ Front wheel drive 2.3 dCi 100-125-150cv	G/L or D/R	04/10>	NEW 555106			364001202R
MASTER III 3300-3500 L2 & L3 Traction AV/ Front wheel drive 2.3 dCi 100-125-150cv	G/L or D/R	04/10>	NEW 555109			8200727569
MASTER III 3500 Propulsion AR avec Chassis cabine/chassis cabs with rear wheel drive 2.3 dCi 100-125-150cv	G/L or D/R	04/10>	NEW 555107			364006372R
MASTER III 3500 Propulsion AR et roues jumelées/ double wheels and rear wheel drive 2.3 dCi 100-125-150cv	G/L or D/R	04/10>	NEW 555213			8200727571
MEGANE I						
MEGANE I 5 portes/doors 1.4-1.6 & 1.9D (freins à tambours/drum brake)	G/L or D/R	07/95 -> 02/99	404570	804570	1440/1080	7700424470-7700834651 7700424924
MEGANE I 5 portes/doors 1.9TD-1.9 dTi & 2.0 115cv (freins à tambours/drum brake)	G/L or D/R	07/95 -> 02/99	404840	804840	1472/1112	7700424472-7700846156 7700420314
MEGANE I phase II 5 portes/doors 1.4-1.4 16V 1.6 16V-1.9 Dci & 1.9 dTi (freins à tambours/drum brake)	G/L or D/R	03/99 -> 09/02	404840	804840	1470/1110	7700424472-7700846156 7700420314
MEGANE I 5 portes/doors 1.8 16V (freins à disques/disc brake)	G/L or D/R	03/99 -> 09/02	404670	804670	1520/1210	7700425324-7700834653
MEGANE I CLASSIC 1.6-2.0-1.9D & 1.9 dTi (freins à tambours/drum brake)	G/L or D/R	07/95 -> 02/99	404840	804840	1470/1110	7700424472-7700846156 7700420314
MEGANE I CLASSIC phase II 1.4-1.4 16V 1.6 16V-1.9D & 1.9 dTi (freins à tambours/drum brake)	G/L or D/R	03/99 -> 09/02	404840	804840	1470/1110	7700424472-7700846156 7700420314
MEGANE I coupé 1.6 (freins à tambours/drum brake)	G/L or D/R	07/95 -> 02/99	404580	804580	1334/1080	7700424923-7700834652
MEGANE I coupé 2.0 & 1.9dTi (freins à tambour/drum brake)	G/L or D/R	07/95 -> 02/99	404710	804710	1360/1110	7700424469-7700846155
MEGANE I coupé & coupé phase II 2.0 16V & 2.0 IDE (freins à disque)	G/L or D/R	07/95 -> 09/02	404680	804680	1410/1210	7700424922-7700834654
MEGANE I phase II coupé 1.4-1.4 16V (freins à tambours/drum brake)	G/L or D/R	03/99 -> 09/02	404580	804580	1330/1080	7700424923-7700834652
MEGANE I phase II coupé 1.6 16V-1.9 dTi & 1.9 DCI (freins à tambours/drum brake)	G/L or D/R	03/99 -> 09/02	404710	804710	1360/1110	7700424469-7700846155
MEGANE I cabriolet/convertible 1.6 & 2.0 115cv (freins à tambours/drum brake)	G/L or D/R	07/95 -> 02/99	404710	804710	1360/1110	7700424469-7700846155
MEGANE I cabriolet/convertible phase II 1.4 16v & 1.6 16v	G/L or D/R	03/99 -> 09/02	404710	804710	1360/1110	7700424469-7700846155
MEGANE I cabriolet/convertible 2.0 16v (freins à disques/disc brake)	G/L or D/R	07/95 -> 02/99	404680	804680	1410/1210	7700424922-7700834654
MEGANE I cabriolet/convertible phase II 2.0 ide (freins à disques/disc brake)	G/L or D/R	03/99 -> 09/02	404680	804680	1410/1210	7700424922-7700834654
MEGANE I Break/SW 1.4 1.4 16V 1.9D & 1.9 dTi (freins à tambours/drum brake)	G/L or D/R	07/95 -> 06/03	404920	804920	1456/1060	7700421024
MEGANE I Break/SW 1.6 16V 1.9 dTi & 1.9 DCI (freins à disques/disc brake)	G/L	07/95 -> 06/03	404930	804930	1520/1210	8200035047
	D/R	07/95 -> 06/03	404931		1480/1170	8200029461

Véhicule Vehicle	Position	Année Year	SEIM P/n	Kit P/n	Longueur Lenght	OE
RENAULT						
MEGANE II						
MEGANE II 1.4 16v 80 & 98cv-1.6 16v-2.0 16v 1.5 DCI 80, 100 & 105cv-1.9DCI 120,130-2.0 DCI 150 & 175cv sauf/except Estate, CC cabriolet/convertible & 4 portes/doors (freins à disques/disc brake)	G/L or D/R	10/02 -> 06/09	404972	804972	2020/1080	8200247041
MEGANE II CC (cabriolet/convertible) 1.6 16v 2.0 16v-2.0 16v Turbo 165cv-1.5 DCI 100 & 105cv-1.9DCI 120,130cv-2.0 DCI 150cv (freins à disques/disc brake)	G/L or D/R	10/02 -> 08/09	404973	804973	1940/1080	8200247042
MEGANE II 4 portes/doors & ESTATE (break) 1.4 16v 80 & 98cv-1.6 16v-2.0 16v 1.5 DCI 80, 100 & 105cv-1.9DCI 120,130-2.0 DCI 150cv (freins à disques/disc brake)	G/L or D/R	10/02 -> 06/09	404974	804974	2070/1080	8200247043-8200243673
MEGANE II SPORT 2.0 16v Turbo RS	G/L or D/R	09/02 -> 12/05	NEW 555110		2068/1134	8200266094
MEGANE II SPORT 2.0 16v Turbo RS	G/L or D/R	12/05 -> 06/09	404972	804972	2020/1080	8200247041
MEGANE III						
MEGANE III all model (frein de parking manuel)	G/L or D/R	11/08 ->	554762			364000005R
MEGANE III all model avec frein automatique/with automatic brake	G/L or D/R	11/08 ->	554404	805076	1883/1062	364000001R
MODUS						
MODUS 1.2 16v 65, 75 & 80cv-1.2 16v Turbo 100cv-1.5DCI 70 & 80 cv (freins à tambours/drum brake)	G/L	09/04 -> 12/07	404658	804657	1380/1230	8200673245-8200269350
	D/R	09/04 -> 12/07	404657		1490/1340	8200673247-8200269348
MODUS 1.4 16v-1.6 16v & 1.5DCI 65cv (freins à disques/disc brake)	G/L	09/04 -> 12/07	404655	804655	1370/1260	8200673248-8200214752
	D/R	09/04 -> 12/07	404656		1270/1150	8200673249-8200214750
MODUS 1.2 16V 75 & 80cv-1.2 Tce 100 cv & 1.5DCI 65, 70, 85cv (sans/without ESP) (freins à tambours/drum brake)	G/L	01/08 -> 12/12	404658	804657	1380/1230	8200673245-8200269350
	D/R	01/08 -> 12/12	404657		1490/1340	8200673247-8200269348
MODUS 1.2 16V 75 & 80cv-1.2 Tce 100 cv 1.6 16v & 1.5DCI 65, 70, 85,105cv (avec/with ESP) (freins à disques/disc brake)	G/L	01/08 -> 12/12	404655	804655	1370/1260	8200673248-8200214752
	D/R	01/08 -> 12/12	404656		1270/1150	8200673249-8200214750
MODUS GRAND						
MODUS 1.2 16V 75 & 80cv-1.2 Tce 100 cv & 1.5DCI 65, 70 & 85cv sans/without ESP (freins à tambours/drum brake)	G/L	01/08 -> 12/12	NEW 555111			8200627462
	D/R	01/08 -> 12/12	NEW 555097			8200577938
MODUS 1.2 16V 75 & 80cv-1.2 Tce 100 cv 1.6 16V 110 cv-1.5DCI 65, 70, 85 & 105cv avec/with ESP (freins à disques/disc brake)	G/L	01/08 -> 12/12	404654	804653	1330/1210	8200673258-8200270182
	D/R	01/08 -> 12/12	404653		1450/1330	8200673259-8200270181
R4						
R4 type R1120 -> serial n° ...621990 et R1123 -> serial n° ...319788	G/L	62 -> mod 67	Not available			854693100-8558157000
	D/R	62 -> mod 67	Not available			854693200-8558158000
R4 frein à l'avant/with front brake type R1120 serial n° ...621991-> & type R1123 serial n° ...319789->	G/L	mod 67 ->	403020		1027/793	7701348035
	D/R	mod 67 ->	403030		1539/1308	7700571740
R4 type R1126 -> serial n° ...196831	G/L	72 -> mod 74	403030		1539/1308	7700571740
	D/R	72 -> mod 74	403020		1026/795	7701348035
R4 type R1126 serial n° ...196832->	G/L	mod 74 ->	403020		1026/795	7701348035
	D/R	mod 74 ->	403030		1539/1308	7700571740
R4 fourg type R2106 -> serial n° ...24876	G/L	66 -> 68	403020		1026/795	7701348035
	D/R	66 -> 68	403030		1539/1308	7700571740
R4 fourg type R2106 serial n° ...24877 -> ...61602	G/L	68 -> mod 71	403040		1049/795	7700510747
	D/R	68 -> mod 71	403930		1559/1308	7700571741
R4 fourg type R2106 serial n° ...61603 -> ...133610	G/L	mod 71 -> 73	403930		1559/1308	7700571741
	D/R	mod 71 -> 73	403040		1049/795	7700510747
R4 fourg type R2106 serial n° ...133611->	G/L	73 ->	403040		1049/795	7700510747
	D/R	73 ->	404260		1435/1185	7700571739

Véhicule Vehicle	Position	Année Year	SEIM P/n	Kit P/n	Longueur Length	OE
RENAULT						
<i>Suite...</i>						
R4 (suite)						
R4 type R1128 -> serial n° ...378298	G/L	78 -> mod 83	403040		1049/795	7700510747
	D/R	78 -> mod 83	403930		1559/1308	7700571741
R4 type R1128 serial n° ...378299 -> ...390245	Primaire Front	mod 83	Not available			7702108773
R4 type R1128 avec frein arrière/with rear brake serial n° ...378299 -> ...390245	G/L	mod 83	403200		1040/920	7701348267
	D/R	mod 83	403210		1215/1090	7701348269
R4 type R1128 serial n° ...390246->	G/L or D/R	83 -> 06/90	403970		1500/1310	7704001812
R4 fourg type R2391 R2392 & R2430	G/L	74 -> 86	403040		1049/795	7700510747
	D/R	74 -> 86	403930		1559/1308	7700571741
R4 fourg type R2370 -> serial n° ...296902	G/L	76 -> mod 83	403930		1559/1308	7700571741
	D/R	76 -> mod 83	403040		1049/795	7700510747
R4 fourg type R2370 serial n° ...296903 -> ...311007	Primaire Front	mod 83	Not available			7702107376
R4 fourg type R2370 serial n° ...296903 -> ...311007	G/L	mod 83	403200		1040/920	7701348267
	D/R	mod 83	403210		1215/1090	7701348269
R4 fourg type R2370 serial n° ...311008->	G/L or D/R	83 -> 86	403960		1640/1450	7704001811
R4 fourg type R2109 -> serial n° ...93763	G/L	72 -> mod 74	403930		1559/1308	7700571741
	D/R	72 -> mod 74	403040		1049/795	7700510747
R4 fourg type R2109 serial n° ...93764->	G/L	74 -> 82	403040		1049/795	7700510747
	D/R	74 -> 82	404260		1435/1185	7700571739
R4 fourg type 210B -> serial n° ...15200	Primaire Front	80 -> 83	Not available			7702108773
R4 fourg type 210B -> serial n° ...15200	G/L	80 -> 83	403200		1040/920	7701348267
	D/R	80 -> 83	403210		1215/1090	7701348269
R4 fourg type 210B serial n° ...15201->	G/L or D/R	83 -> 06/88	403970		1500/1310	7704001812
R4 fourg type 239B -> serial n° ...479	Primaire Front	82 -> 83	Not available			7702108773
R4 fourg type 239B -> serial n° ...479	G/L	82 -> 83	403200		1040/920	7701348267
	D/R	82 -> 83	403210		1215/1090	7701348269
R4 fourg type 239B serial n° ...480->	G/L or D/R	83 -> 06/88	403970		1500/1310	7704001812
R4 Type 112C & S128	G/L or D/R	06/89 -> 06/90	403970		1500/1310	7704001812
R5						
R5 L	Primaire Front	01/74 -> 06/86	402100		480/212	7700539993
R5 L	G/L	01/74 -> 07/79	403100		2135/651	7700539991
	D/R	01/74 -> 07/79	403110		877/651	7700539992
R5 L	G/L	07/79 -> 07/82	403940		2175/625	7700554894
	D/R	07/79 -> 07/82	403950		910/625	7700554896
R5 L	G/L	07/82 -> 06/86	403960		1640/1410	7704001811
	D/R	07/82 -> 06/86	403970		1500/1310	7704001812
R5 TL GTL LS TS Alpine & Laureate	G/L	07/79 -> 06/86	403960		1640/1410	7704001811
	D/R	07/79 -> 06/86	403970		1500/1310	7704001812
R5 Alpine Turbo			Not available			7701022736-6000056930
R5 Turbo II			Not available			
R9 & R11						
R9 & R11 all model sauf/except TURBO	G/L or D/R	07/81 -> 06/89	403980	803980	1460/1230	7704001610-7700760876 7700759586
R9 & R11 TURBO Ch. 8610->	G/L or D/R	ch 8610 -> 06/89	404140		1430/1230	7700773849
R18 & FUEGO						
R18 & FUEGO L TL GTL GTS TS AMERICAN	G/L	04/78 -> 12/87	403630		1150/550	7704002268
	D/R	04/78 -> 12/87	403620		925/550	7704002272
R18 & FUEGO TX GTX	G/L	04/78 -> 12/87	403990		1190/540	7704002269
	D/R	04/78 -> 12/87	404000		960/540	7704002273
R18 & FUEGO TD GTD	G/L	07/80 -> 01/84	403990		1190/540	7704002269
	D/R	07/80 -> 01/84	404000		960/540	7704002273

Véhicule Vehicle	Position	Année Year	SEIM P/n	Kit P/n	Longueur Lenght	OE
RENAULT						
<i>Suite...</i>						
R18 & FUEGO (suite)						
R18 & FUEGO TD GTD	G/L	01/84 -> 12/87	403630		1150/550	7704002268
	D/R	01/84 -> 12/87	403620		925/550	7704002272
R18 & FUEGO Turbo essence/gasoline	G/L	09/80 -> 12/87	404010		1240/680	7704002266
	D/R	09/80 -> 12/87	404020		990/680	7704002267
R19 & CHAMADE						
R19 / CHAMADE 1.1-1.2-1.4-1.7-1.9D 1.9 Turbo D & 1.9 Turbo DX (freins à tambours/drum brake)	G/L or D/R	07/88 -> 04/92	404500	803450	1564/1260	7700816858-7700781393
R19 / CHAMADE 1.8 16S (freins à disques/disc brake)	G/L or D/R	07/88 -> 04/92	404480	804480	1570/1300	7700817136-7700781394
R19 / CHAMADE 1.2-1.4-1.4i-1.7-1.7i-1.8i 1.9D-1.9 Turbo D sans/without ABS (freins à tambours/drum brake)	G/L or D/R	04/92 -> 03/96	404500	803450	1564/1260	7700816858-7700781393
R19 / CHAMADE 1.7i-1.8i & 1.9 Turbo D avec/ with ABS & 1.8 16S (freins à disques/disc brake)	G/L or D/R	04/92 -> 03/96	404480	804480	1570/1300	7700817136-7700781394
R20						
R20 all model	G/L or D/R	11/75 -> 12/84	403700	803700	1000/774	7700571639-7701348316 7700640491
R21 & NEVADA						
R21 TS TSE GTS GTSi TD GTD (freins à tambours/drum brake)	G/L or D/R	07/89 -> 12/95	404130	804130	1465/1230	7700766098
R21 GTX & 2.0 Turbo avec/with ABS (freins à disques/disc brake)	G/L or D/R	01/86 -> 12/95	404180	804180	1576/1380	7700777520
R21 GTX TXE TXI Turbo D & DX sans/without ABS (freins à tambours/drum brake)	G/L or D/R	07/89 -> 12/95	404120	804120	1500/1230	7700769840
NEVADA TSi RN 1.7 GTSi TD GTD RN 2.1d Turbo D & RT 2.1dt (freins à tambours/drum brake)	G/L or D/R	01/86 -> 12/95	404150	804150	1645/1380	7700769842
NEVADA TXI & Rti (freins à disques/disc brake)	G/L or D/R	01/86 -> 12/95	404510	804510	1726/1530	7700785543
R21 all model 4x4 (freins à disques/disc brake)	G/L or D/R	01/86 -> 06/89	Not available		1515/1220	7700785175
R25						
R25 TS GTS GTX TD GTD TURBO D/DX sans/without ABS	G/L or D/R	03/84 -> 06/92	403700	803700	1000/775	7700571639-7701348316
R25 GTX TXI V6 inj V6 Turbo Turbo D/DX avec/ with ABS (freins à disques/disc brake)	G/L or D/R	03/84 -> 06/92	403710	803710	1065/934	7700571640-77011348781
R30						
R30 Turbo diesel	G/L or D/R	10/81 -> 12/83	403700	803700	1000/774	7701571639
R30 TS TX	G/L or D/R	03/75 -> 12/83	403710	803710	1090/970	7701348900
SCENIC						
SCENIC I all model 1.4 1.6 2.0 1.9D 1.9dTet 1.9dTi (freins à tambours/drum brake)	G/L or D/R	09/96 -> 08/99	404690	804690	1470/1080	7700424468-7700834655
SCENIC I phase II 1.4 16V 1.6 16V 1.8 16V 2.0 16V 1.9D 1.9dTi & 1.9 dCi (freins à disques/disc brake)	G/L	08/99 -> 06/03	404940	804940	1510/1210	7700438266
	D/R	08/99 -> 06/03	404941		1480/1180	7700432012
SCENIC I phase II RX4 (4X4)	G/L or D/R	08/99 -> 06/03	404950	804950	1470/1170	7700432013
SCENIC II all model	G/L or D/R	06/03 -> 09	404974	804974	2070/1080	8200247043
GRAND SCENIC II all model	G/L or D/R	06/03 -> 09	404659	804659	2100/1080	8200229445
SCENIC & GRAND SCENIC avec/with frein automatique (seulement/only cable)	G/L or D/R	06/03 -> 09	Not available			7701209682
SAFRANE						
SAFRANE all model sauf/except 4x4	Primaire Front	03/92 ->	402440		1740/1530	7700812519
SAFRANE 2.0-2.2 & 2.1TURBO D sans/ without ABS (freins à tambours/drum brake)	G/L	03/92 -> 02/95	404330	804330	700/540	7700812520
	D/R	03/92 -> 02/95	404340		952/710	7700812521
SAFRANE 2.0-2.2-2.5-3.0 V6 2.1 & 2,5 TURBO D avec/with ABS (freins à disques/disc brake)	G/L	03/92 ->	404350	804350	850/760	7700812524
	D/R	03/92 ->	404360		1090/925	7700812525

Véhicule Vehicle	Position	Année Year	SEIM P/n	Kit P/n	Longueur Lenght	OE
RENAULT						
<i>Suite...</i>						
SAFRANE (suite)						
SAFRANE BI TURBO & V6 QUADRA (freins à disques/disc brake)	G/L	03/92 ->	Not available			7700815320
	D/R	03/92 ->	Not available			7700815321
SUPER 5						
SUPER 5 all model sauf/except GT TURBO	G/L or D/R	09/84 -> 12/96	403140	803140	1330/1100	7700754882
SUPER 5 GT TURBO	G/L or D/R	09/84 -> 12/96	404270		1405/1210	6001006990
TRAFIC						
TRAFIC all model sauf/except 4X4	Primaire Front	09/80 -> 07/85	402920		690/430	7700689738
TRAFIC all model 4X4	Primaire Front	09/80 -> 02/89	Not available		720/420	7700724994
TRAFIC all model sauf/except 4X4	G/L	09/80 -> 07/85	404040	804040	1300/886	7000689739-7700709619
	D/R	09/80 -> 07/85	404050		1432/998	7000689740
TRAFIC all model sauf/except 4X4	Primaire Front	08/85 -> 02/89	402920		690/430	7700689738
TRAFIC 1.4-1.8-2.0 & 2.1D	G/L	08/85 -> 02/89	404200	804200	1291/892	7700732030
	D/R	08/85 -> 02/89	404210		1425/1020	7700732031
TRAFIC all model 4x4	G/L	08/85 -> 02/89	404470		1330/930	7700732032
	D/R	08/85 -> 02/89	404460		1390/1020	7700723015-7700307719 7700722555-4400247-9108247
TRAFIC all model sauf/except 4x4	Primaire Front	03/89 -> 09/01	402930		755/522	7700307717-7700748444
TRAFIC all model 4x4	Primaire Front	03/89 -> 09/01	402430		750/450	7700748445
TRAFIC all model sans/without ABS	G/L	03/89 -> 09/01	404978	804978	1330/925	7700307720
	D/R	03/89 -> 09/01	404979		1425/1020	7700307721
TRAFIC 2.4D-2.5D & 4x4 avec/with ABS	G/L	03/89 -> 09/01	404980	804980	1295/926	7700723014-7700307718 7700722556-4400243-9108243
	D/R	03/89 -> 09/01	404460		1390/1020	7700723015-7700307719 7700722555-4400247-9108247
TRAFIC II						
TRAFIC II all model	Primaire Front	09/01 -> 05/06 05/06 ->	653152		502/260	365301862R-93864341 4421102-7700312835 91166639 4408726-3640200QAB
TRAFIC II all model avec chassis court/ with short wheelbase	Intermediate	09/01 -> 05/06 05/06 ->	653299		1185	365301673R-93864840 4420800-7700313058 91165521-4408735 3651800QAA
TRAFIC II all model avec chassis long/ with long wheelbase	Intermediate	09/01 -> 05/06 05/06 ->	404982		1585	365301796R-4420801 93864842-8200008473- 4408730-91165522 3651800QAC
TRAFIC II all model chassis cabine/chassis cabs	Intermediate	09/01 -> 05/06 05/06 ->	554394		1883	365309636R-4421104 93864843-8200316762 8201018831-4413816 93852378
TRAFIC II all model (freins à disques/disc brake)	G/L	09/01 -> 05/06 05/06 ->	404983	804983	1495/1365	8200263819-8200178389 7700312837-4414821 93852188-4408734-4411413 91168672
	D/R	09/01 -> 05/06 05/06 ->	404984		1590/1465	8200263821 -8200178390-7700312836 4414822-93852189-4408727 4411415-91168673

Véhicule Vehicle	Position	Année Year	SEIM P/n	Kit P/n	Longueur Length	OE
RENAULT						
<i>Suite...</i>						
TWINGO						
TWINGO I all model sans/without ABS	G/L or D/R	04/93 -> 06/07	404320	804320	1450/1050	7700424929-7700824636
TWINGO I all model avec/with ABS	G/L or D/R	04/93 -> 06/07	404850	804850	1460/1060	7700427498-8200700688
TWINGO II						
TWINGO II all model sauf/except 1.6 16v	G/L	06/07 ->	554407	805079	1273/958	8200428320
133cv Renault sport & Gordini	D/R	06/07 ->	554408		1355/1043	8200428323
TWINGO II Renault Sport & Gordini 1.6 16v 133cv	G/L	06/07 ->	NEW 555112			8200676001
	D/R	06/07 ->	NEW 555113			8200676002
VELSATIS						
VELSATIS all model		03/02 ->	Not available			8200418646
WIND (cabriolet/convertible)						
WIND (cabriolet/convertible) 1.2TCe 100cv & 1.6 16v 133cv	G/L	06/10->	NEW 555112			8200676001
	D/R	06/10->	NEW 555113			8200676002
ROVER						
25						
25 all model (freins à tambours/drum brake)	G/L	01/00 ->	554411		1743/1520	GVC902386-SPB000350
	D/R	01/00 ->	554412		1713/1488	GVC902387-SPB000340
25 all model (freins à disques/disc brake)	G/L	01/00 ->	356306		1782/1560	GVC902382-SPB000370
	D/R	01/00 ->	356307		1812/1588	GVC902383-SPB000360
45						
45 all model (freins à tambours/drum brake)	G/L	02/00 ->	356311		1485/1320	SPB000570-GVC902375 SPB101290
	D/R	02/00 ->	356310		1512/1341	SPB000560-GVC902376 SPB100700
45 all model (freins à disques/disc brake)	G/L	02/00 ->	356304		1636/1449	SPB000590-GVC902389 SPB100730
	D/R	02/00 ->	356305		1655/1469	SPB000580-GVC902388 SPB100720
75						
75 all model	G/L or D/R	06/99 ->	554410		1570/1462x2	GVC902399-SPB101550 Kit:SPB000230
100						
100 all model (câble sans protection thermique/without thermal protection)	Unique Single	05/90 -> 05/95	356300		2185/2x412 +1136	GVC1059-GVC1027
100 all model (câble avec protection thermique/with thermal protection)	Unique Single	05/90 -> 05/95	356301		2185/2x415 +1136	GVC1060-GVC2379
200						
200 phase I all model sans/without ABS (freins à tambours/drum brake)	G/L	10/89 -> 12/94	356303		1505/1330	GVC1058-GVC1054-GVC902358
	D/R	10/89 -> 12/94	356302		1530/1355	GVC1057-GVC902357
200 phase I all model avec/with ABS (freins à disques/disc brake)	G/L	10/89 -> 12/94	356309		1655/1450	GVC1056-902356
	D/R	10/89 -> 12/94	356308		1680/1480	GVC1055-902355
200 phase II all model sans/without ABS (freins à tambours/drum brake)	G/L	01/95 -> 12/99	554411		1743/1520	GVC902386-SPB000350
	D/R	01/95 -> 12/99	554412		1713/1488	GVC902387-SPB000340
200 phase II all model avec/with ABS (freins à disques/disc brake)	G/L	01/95 -> 12/99	356306		1782/1560	GVC902382-SPB000370
	D/R	01/95 -> 12/99	356307		1812/1588	GVC902383-SPB000360
200 coupé cabriolet/convertible (freins à tambours/drum brake)	G/L	01/95 -> 12/99	356303		1505/1330	GVC1058-GVC1054-GVC902358
	D/R	01/95 -> 12/99	356302		1530/1355	GVC1057-GVC902357
200 coupé cabriolet/convertible (freins à disques/disc brake)	G/L	01/95 -> 12/99	356309		1655/1450	GVC1056-902356
	D/R	01/95 -> 12/99	356308		1680/1480	GVC1055-902355
400						
400 phase I all model sans/without ABS (freins à tambours/drum brake)	G/L	10/89 -> 12/94	356303		1505/1330	GVC1058-GVC1054-GVC902358
	D/R	10/89 -> 12/94	356302		1530/1355	GVC1057-GVC902357
400 phase I all model avec/with ABS (freins à disques/disc brake)	G/L	10/89 -> 12/94	356309		1655/1450	GVC1056-902356
	D/R	10/89 -> 12/94	356308		1680/1480	GVC1055-902355

Véhicule Vehicle	Position	Année Year	SEIM P/n	Kit P/n	Longueur Length	OE
ROVER Suite...						
400 (suite)						
400 phase II all model sans/without ABS (freins à tambours/drum brake)	G/L	01/95 -> 12/99	356311		1485/1320	SPB000570-GVC902375 -SPB101290
	D/R	01/95 -> 12/99	356310		1512/1341	SPB000560-GVC902376 SPB100700
400 phase II all model avec/with ABS (freins à disques/disc brake)	G/L	01/95 -> 12/99	356304		1636/1449	SPB000590-GVC902389 -SPB100730
	D/R	01/95 -> 12/99	356305		1655/1469	SPB000580-GVC902388 SPB100720
600						
600 all model	G/L	08/93 -> 11/98	731318		1870/1632	47560SN7953-GVC902371
	D/R	08/93 -> 11/98	731319		1870/1632	47510SN7952-GVC902372 SPB100441EVA
820						
820 all model		09/86 -> 11/98	Not available			
MAESTRO						
MAESTRO		83 -> 93	Not available			
METRO						
METRO all model	Unique Single	05/90 -> 05/95	356300		2185/2x412 +1136	GVC1059-GVC1027
MONTEGO						
MONTEGO		84 -> 93	Not available			
SAAB						
9-3						
9-3 all model (freins à disques/disc brake)	Unique Single	02/98 -> 08/02	554413		2180/1607+ 1425/860	4839874-4543104
9-3 all model (freins à disques/disc brake)	G/L or D/R	09/02 ->	554414		1932/1728	12801833
9-5						
9-5 all model	Primaire Front	08/97 -> 05	554415		342	4905980
9-5 all model	Unique Single	08/97 -> 05	554416		1410/1038x2	4908356-5059829
99 900 & 9000						
99 900 & 9000			Not available			
SEAT						
ALHAMBRA						
ALHAMBRA all model	Primaire Front	05/96 -> 05/10	Not available			7M3711476
ALHAMBRA all model	Intermediate	05/96 -> 05/10	652151		653	7M3711472-7M0711472A- 1013482
ALHAMBRA all model	G/L or D/R	05/96 -> 05/10	553180	853180	1230/1130	7M3609701C-7M0609701B 95VW2A603AC
ALTEA						
ALTEA all model	G/L or D/R	06/04 -> 05/09 ->	554417		1447/805	1K0609721BB
AROSA						
AROSA all model (freins à tambours/drum brake)	G/L or D/R	07/97->Ch.6HW028000	553211	853211	1395/800	6X0609721C
AROSA all model (freins à tambours/drum brake)	G/L or D/R	Ch.6HW028001-> 11/00	553200	853200	1392/798	6X0609721H-6X0609721F
AROSA avec/with ABS (freins à disques/disc brake)	G/L or D/R	01/98 -> 11/00	553210	853210	1500/970	6X0609721E-6X0609721D
CORDOBA						
CORDOBA berline/sedan & break 1.6 75cv-1.8 (freins à tambours/drum brake)	G/L or D/R	11/97-> 10/02	553120	853120	1510/970	6N0609721G-6N0609721A 6N0609721B-6N0609721E

Véhicule Vehicle	Position	Année Year	SEIM P/n	Kit P/n	Longueur Lenght	OE
SEAT						
CORDOBA (suite)						
CORDOBA berline/sedan & break 1.9D & 1.9 SDI (freins à tambours/drum brake)	G/L or D/R	12/93-> CH.6KW000537	553120	853120	1510/970	6N0609721G-6N0609721A 6N0609721B-6N0609721E
CORDOBA berline/sedan & break 1.9D & 1.9 SDI (freins à tambours/drum brake)	G/L or D/R	CH.6KW169290 -> 10/02	723360	823360	1515/955	6N0609721K
CORDOBA berline/sedan & break all model 1.9 TDI 90& 110cv (freins à disques/disc brake)	G/L or D/R	12/93 -> 10/02	723361	823361	1641/1132	6N0609721H-6N0609721M -6N0609721L
CORDOBA II 1.4 16v 75cv-1.4TDI 75cv-1.9SDI (freins à tambours/drum brake)	G/L or D/R	10/02 -> 05/09	553223	853223	1580/918	6Q0609721M-6Q0609721B -6Q0609721H
CORDOBA II 1.4 16v 100cv-1.9TDI 100 & 130cv (freins à disques/disc brake)	G/L or D/R	10/02 -> 05/09	554419	805081	1645/1043	6Q0609721K-6Q0609721L -6Q0609721F
EXEO & EXEO ST						
EXEO & EXEO ST all model	G/L	02/09->	554014	805002	1928/1765	8E0609721AQ-8E0609721L 8E0609721AF-8E0609721AG 8E0609721N-8E0609721H 8E0609721D-8E0609721AH 8E0609721AS
	D/R	02/09->	554015		2005/1843	8E0609722AN-8E0609722L 8E0609722AF-8E0609722AG 8E0609722N-8E0609722H 8E0609722D-8E0609722AQ 8E0609722AS
IBIZA						
IBIZA I all model	Primaire Front	10/85 -> 04/93	722010		925	SE022167315A-SE022167316A -X039607270
IBIZA I all model	Unique Single	10/85 -> 04/93	723000		2275/2x780	SE022167320A
IBIZA II all model (freins à tambours/drum brake)	G/L or D/R	05/93->Ch. 6K-ZR037976 05/93->Ch. 6K-ZR549075	723310		1503/935	6K0609721
IBIZA II 1.0-1.4-1.6-1.8 & all model diesel (freins à tambours/drum brake)	G/L or D/R	Ch. 6K-ZR037977-> 6K-ZR126718 Ch. 6K-ZR549076-> 6K-ZR663842	723320	823320	1532/985	6K0609721C
IBIZA II 1.0-1.4-1.6-1.8 (freins à tambours/drum brake)	G/L or D/R	Ch.6K-ZR126719->04/96 Ch.6K-ZR663843->04/96	554517	805113	1512/953	6N0609721F-6N0609721J
IBIZA II all model diesel (freins à tambours/drum brake)	G/L or D/R	Ch.6K-ZR126719-> 04/96 Ch.6K-ZR663843-> 04/96	553120	853120	1510/970	6N0609721G-6N0609721A 6N0609721B-6N0609721E
IBIZA II 1.8-GT 2.0 & GTI (freins à disques/disc brake)	G/L or D/R	05/93 ->Ch.6K-ZR037976 05/93 ->Ch.6K-ZR549075	723330		1600/1000	6K0609721B-6K0609721A
IBIZA II 1.8-GT 2.0 & GTI (freins à disques/disc brake)	G/L or D/R	Ch.6K-ZR037977-> 6K-ZR085725 Ch. 6K-ZR549076-> 6K-ZR610014	723340		1630/1020	6K0609721D
IBIZA II 1.8-GT 2.0 & GTI (freins à disques/disc brake)	G/L or D/R	CH 6K-ZR085726-> 6K-ZR126718 CH 6K-ZR610015-> 6K-ZR663842	723361	823361	1641/1132	6N0609721H-6N0609721M -6N0609721L
IBIZA II 1.8-GT 2.0 & GTI (freins à disques/disc brake)	G/L or D/R	6K-ZR126719-> 6K-ZR663843->	Not available			6K0609721F
IBIZA II 1.0-1.4-1.6-1.9D-1.9 SDI-1.9TD-1.9 TDI 90cv (freins à tambours/drum brake)	G/L or D/R	05/96 ->09/99	554517	805113	1512/953	6N0609721J-6N0609721F
IBIZA II 1.4-1.9TD-1.9 TDI 90cv (freins à tambours/drum brake)	G/L or D/R	05/96 ->03/02	723360	823360	1515/955	6N0609721K
IBIZA II 1.8 Turbo 20v-1.9 TDI 110cv (freins à disques/disc brake)	G/L or D/R	05/96 ->03/02	723361	823361	1641/1132	6N0609721M-6N0609721L -6N0609721H-6N0609721M
IBIZA III 1.2 16v-1.416v 75cv-1.4TDI 70-75 & 80cv (freins à tambours/drum brake)	G/L or D/R	03/02 -> 12/09	553223	853223	1580/918	6Q0609721M-6Q0609721B -6Q0609721H

Véhicule Vehicle	Position	Année Year	SEIM P/n	Kit P/n	Longueur Lenght	OE
SEAT						
						<i>Suite...</i>
IBIZA (suite)						
IBIZA III 1.4 16v 85 & 100cv-1.8i Turbo 20v 1.9SDI-1.9TDI 100-130-160cv (freins à disques/disc brake)	G/L or D/R	03/02 -> 12/09	554419	805081	1645/1043	6Q0609721K-6Q0609721L -6Q0609721F
IBIZA IV 1.2 70cv-1.4 85cv-1.2TDI 75cv- 1.4 TDI 80cv (freins à tambours/drum brake)	G/L or D/R	05/08 -> 02/12 ->	554420	805082	1588/923	6R0609721B
IBIZA IV 1.2TSI 105cv 1.4i 85cv-1.4TSI 150cv- 1.6 16v-1.6 TDI 90 & 105cv-2.0 TDI 143cv (freins à disques/disc brake)	G/L or D/R	05/08 -> 02/12 ->	554421	805083	1642/1044	6C0609721-6R0609721C
INCA						
INCA all model	G/L or D/R	01/96 ->	723311		1670/1120	6K9609721
LEON						
LEON all model all model avec embout hexagonal/with hexagonal endfitting	G/L or D/R	04/00 ->Ch.1MY006500	553081		1693/1055	1J0609721E-1J0609721H
LEON all model avec embout en forme de boule/ with ball shaped endfitting (freins à disques/ disc brake)	G/L or D/R	Ch.1MY006501->10/06	723362		1688/1064	1J0609721AG-1J0609721AC- 1J0609721AD-1J0609721AG 1J0609721AT-1J0609721AP 1J0609721AP-1J0609721T
LEON 4x4 1.8 20V 2.8 V6 & TDI 150 cv	G/L or D/R	04/00 -> 10/06	553083		1723/1090	1J0609721L-1J0609721R 1J0609721AR
LEON II all model	G/L or D/R	09/05 ->	554417		1447/805	1K0609721BB
LEON II all model	G/L or D/R	09/05 ->	553084		1447/807	1K0609721BE-1K0609721Q 1K0609721S
LEON II all model sauf/except 2.0 TSI-2.0TDI 140 & 170cv	G/L or D/R	05/09 ->	554417		1447/805	1K0609721BB
LEON II all model 2.0 TSI-2.0TDI 140 & 170cv	G/L or D/R	05/09 ->	553084		1447/807	1K0609721BE-1K0609721Q 1K0609721S
LEON III 1.2 TSI 85 & 105cv-1.4 TSI 122 & 140cv-1.6 TDI 90 & 105cv & 2.0 TDI 150cv (freins à disques/disc brake)	G/L or D/R	10/12->	NEW 555185		1717/1035	5Q0609721BD
LEON III	G/L or D/R	10/12->	NEW 555186		1683/1035	5Q0609721BE
MALAGA						
MALAGA all model	Primaire Front	85 -> 07/92	722010		925	SE022167315A-SE022167316A -X039607270
MALAGA all model	Unique Single	85 -> 07/92	723000		2275/2x780	SE022167320A
MARBELLA						
MARBELLA all model	Unique Single	11/86 -> 12/98	554422		2668/2x1012	SE141167358A
MII						
MII all model	G/L or D/R	->21/11/11	NEW 555114		1528/820	1S0609721A
MII all model	G/L or D/R	21/11/11->	NEW 555115		1518/810	1S0609721C
RONDA						
RONDA all model	Primaire Front	02/82 -> 92	722010		925	SE022167315A-SE022167316A -X039607270
RONDA all model	Unique Single	02/82 -> 92	723000		2275/2x780	SE022167320A
TERRA						
TERRA all model	Unique Single	86 ->	723363		3170/2x1248	SE24167358A
TOLEDO						
TOLEDO I all model sauf/except 1.8 16v & 2.0 GT (freins à tambours/drum brake)	G/L or D/R	01/96 -> 04/99	553000	853000	1527/1090	191609721E
TOLEDO I 1.8 16v & 2.0 GT (freins à disques/disc brake)	G/L or D/R	01/96 -> 04/99	553030	853030	1620/1220	191609721F-1L0609721A -1L0609721B
TOLEDO II all model all model avec embout hexagonal/with hexagonal endfitting	G/L or D/R	04/98 ->Ch.1MY006500	553081		1693/1055	1J0609721E-1J0609721H

Véhicule Vehicle	Position	Année Year	SEIM P/n	Kit P/n	Longueur Lenght	OE
SEAT Suite...						
TOLEDO (suite)						
TOLEDO II all model avec embout en forme de boule/with ball shaped endfitting (freins à disques /disc brake)	G/L or D/R	Ch. 1MY006501->09/04	723362		1688/1064	1J0609721AQ-1J0609721AC 1J0609721AD-1J0609721AG 1J0609721AT-1J0609721AP 1J0609721AP-1J0609721T
TOLEDO III all model	G/L or D/R	09/04 -> 05/09	553084		1447/807	1K0609721BE-1K0609721Q 1K0609721S
TOLEDO IV 1.2 MPI 75cv (freins à tambours/drum brake)	G/L or D/R	06/12 ->	NEW 555183		1707/959	6R0609721H
TOLEDO IV 1.2 TSI 85 & 105cv-1.4 TSI 122cv-1.6 TDI 105cv (freins à disques/disc brake)	G/L or D/R	06/12 ->	NEW 555184		1780/1099	6R0609721E
SKODA						
CITIGO						
CITIGO all model	G/L or D/R	>21/11/11	NEW 555114		1528/820	1S0609721A
CITIGO all model	G/L or D/R	21/11/11->	NEW 555115		1518/810	1S0609721C
FABIA I & II						
FABIA & FABIA COMBI I & II all model (freins à tambours/drum brake)	G/L or D/R	04/00 -> 03/10 03/10 ->	553223	853223	1580/918	6Q0609721M-6Q0609721B -6Q0609721H
FABIA & FABIA COMBI I & II all model (freins à disques/disc brake)	G/L or D/R	04/00 -> 03/10 03/10 ->	554419		1645/1043	6Q0609721K-6Q0609721L -6Q0609721F
FABIA II CROSS	G/L or D/R	05/07 ->	554418		1581/916	6Q0609721N-6Q0609721J 6Q0609721D
FAVORIT						
FAVORIT all model	G/L or D/R	06/89 -> 11/92	Not available		1757/1465	115332750-115332751
FAVORIT all model	G/L or D/R	12/92 -> 06/93	553222		1750/1440	6U0609721
FELICIA						
FELICIA all model	G/L or D/R	01/95 -> 11/00	553222		1750/1440	6U0609721
OCTAVIA & OCTAVIA COMBI						
OCTAVIA (1U2) & COMBI (1U5) all model (freins à tambours/drum brake)	G/L or D/R	05/97->Ch. 1U-Y294000	554726		1620/940	1J0609721D
OCTAVIA (1U2) & COMBI (1U5) all model (freins à tambours/drum brake)	G/L or D/R	Ch. 1U-Y294001->06/04	553203	853203	1620/944	1J0609721BA-1J0609721S -1J0609721J-1J0609721AS
OCTAVIA (1U2) & COMBI (1U5) all model avec embout hexagonal/with hexagonal endfitting (freins à disques/disc brake)	G/L or D/R	05/97 ->Ch. 1U-Y294000	553081		1693/1055	1J0609721E-1J0609721H
OCTAVIA (1U2) & COMBI (1U5) all model avec embout en forme de boule/with ball shaped endfitting (freins à disques/disc brake)	G/L or D/R	Ch. 1U-Y294001-> 06/04	723362		1688/1064	1J0609721AC-1J0609721AD 1J0609721AQ-1J0609721AG 1J0609721AT-1J0609721AP 1J0609721AP-1J0609721T
OCTAVIA (1U2) & COMBI (1U5) 1.8T 4x4	G/L or D/R	05/97-> 06/04	553083		1723/1090	1J0609721R-1J0609721L 1J0609721AR
OCTAVIA (1Z3) & COMBI (1Z5) all model	G/L or D/R	06/04 -> 10/08 ->	554417		1447/805	1K0609721BB-1K0609721AA -1K0609721AT-1K0609721T
OCTAVIA III 1.2 TSI 85 & 105cv-1.4 TSI 140cv-1.8 TSI 180cv-1.6 TDI 105cv & 2.0 TDI 150cv (freins à disques/disc brake)	G/L or D/R	02/13->	NEW 555187		1765/1035	5Q0609721BF-5Q0609721BC
OCTAVIA III	G/L or D/R	02/13->	NEW 555188		1543/822	5Q0609721AQ-5Q0609721AT
RAPID						
RAPID 1.2 MPI 75cv (freins à tambours/drum brake)	G/L or D/R	10/12 ->	NEW 555183		1707/959	6R0609721H
RAPID 1.2 TSI 85 & 105cv-1.4 TSI 122cv-1.6 TDI 105cv (freins à disques/disc brake)	G/L or D/R	10/12 ->	NEW 555184		1780/1099	6R0609721E
ROOMSTER						
ROOMSTER all model (freins à tambours/drum brake)	G/L or D/R	09/06 ->	554423		1805/940	6Q7609721D-6Q7609721B
ROOMSTER all model (freins à disques/disc brake)	G/L or D/R	09/06 ->	554424		1880/1074	6Q7609721E-6Q7609721C

Véhicule Vehicle	Position	Année Year	SEIM P/n	Kit P/n	Longueur Length	OE
SKODA						
SUPERB I & II						
SUPERB (3U4) all model	G/L	06/02 -> 06/08	554425		1989/1680+ 148	3BD609721-3BD609721A -3BD609721C
	D/R	06/02 -> 06/08	554426		1989/1680+ 148	3BD609722-3BD609722A -3BD609722C
SUPERB II (3T4) all model	G/L or D/R	06/08 -> 07/12/08	554427		1590/780	3T0609721-3T0609721A
SUPERB II (3T4) all model	G/L or D/R	08/12/08 ->	NEW 555116		1615/805	3T0609721C-3T0609721B
YETI						
YETI all model y compris/include 4x4	G/L or D/R		554417		1447/805	1K0609721BB-1K0609721AA 1K0609721AF-1K0609721T
SMART						
FORTWO I & II						
FORTWO all model y compris/include cabriolet/ convertible	Kit G/L + D/R	04/00 -> 12/06	554428		990/805x2	0004161V003-204220047 -4161V001-0004161V002 204224719-204220087
FORTWO II all model y compris/include cabriolet/ convertible	Kit G/L + D/R	04/07 ->	554429		1028/862x2	4514200485-4514200385
FORFOUR						
FORFOUR all model (freins à tambours/drum brake)	G/L	04/04 ->	554430	805084	1525/1315	4544200185
	D/R	04/04 ->	554431		1560/1345	4544200085
FORFOUR all model (freins à disques/disc brake)	G/L	04/04 ->	554432	805085	1540/1390	4544200385
	D/R	04/04 ->	554433		1570/1420	4544200485
ROADSTER						
ROADSTER all model	Kit G/L + D/R	03 ->	NEW 555117		1035/872x2	0018975V001000000
SUBARU						
FORESTER						
FORESTER all model		> 11/97	Not available			
FORESTER all model	Primaire Front	11/97 -> 06	Not available			
FORESTER all model	G/L	11/97 -> 06	554434		1610/1341	26051FC030
	D/R	11/97 -> 06	554435		1590/1321	26051FC020
IMPREZA						
IMPREZA all model	Primaire Front	07/97 -> 12/00	Not available			
IMPREZA all model	G/L	07/97 ->	554436		1601/1332	26051FA150
	D/R	07/97 ->	554437		1578/1310	26051FA140
SUZUKI / SANTANA						
ALTO						
ALTO II all model	G/L	06/02 -> 12/06	554685		1478/1268	54402M79G00
	D/R	06/02 -> 12/06	554686		1475/1263	54402M79G10
ALTO III all model	G/L	03/09 ->	554687			54402M68K00-365314A00B
	D/R	03/09 ->	554688			54401M68K00-365304A00C
IGNIS						
IGNIS all model	G/L or D/R	10/02 -> 09/03	554438		1512/1296	5440278F10-5440278F11
IGNIS II all model	G/L	09/03 ->	554439		1532/1285	5442086G00
	D/R	09/03 ->	554440		1523/1276	5441086G00
JIMNY						
JIMNY all model	G/L	00 ->	554441	805086	1570/1370	5442081A02-5442081A01
	D/R	00 ->	554442		1588/1375	5441081A02-5441081A01

Véhicule Vehicle	Position	Année Year	SEIM P/n	Kit P/n	Longueur Lenght	OE
SUZUKI / SANTANA						
SAMURAI						
SAMURAI SJ413 all model	G/L	90 -> 98	733509		1340/1170	4504100000
SAMURAI SJ413 all model sauf/except injection	D/R	90 -> 98	733506		1340/1175	4504000000
SAMURAI SJ413 Uniquement/only injection engine	D/R	90 -> 98	733507		1440/1260	4506800000-450688C00
SAMURAI SJ413 SW châssis long/long wheelbase	D/R	90 -> 98	733508		1560/1380	4504800000
SAMURAI SJ413 all model	G/L	98 -> 02	554689		1348/1165	4509684C00
	D/R	98 -> 02	554690		1445/1264	4506884C00
SPLASH						
SPLASH all model	G/L	04/08 ->	554691		1600/1368	5440251K00-4709864 93195342
	D/R	04/08 ->	554692		1600/1368	5440151K00-4709863 93195341
SWIFT						
SWIFT III all model (freins à tambours/drum brake)	G/L	03/05 -> 09/11	554693		1625/1395	5440262J00
	D/R	03/05 -> 09/11	554694		1625/1395	5440162J00
SWIFT III all model (freins à disques/disc brake)	G/L	03/05 -> 09/11	NEW 555118		1494/1310	5440257K00
	D/R	03/05 -> 09/11	NEW 555119		1494/1310	5440157K00
SX4						
SX4 all model	G/L	04/06 -> 12/09	554695		1787/1542	5440279J00-71742845
	D/R	04/06 -> 12/09	554696		1797/1548	5440179J00-71742844
SX4 all model	G/L	09/09 ->	NEW 554932		1638/1458	71750425-5440255L10
	D/R	09/09 ->	NEW 554933		1638/1458	71750424-5440155L10
VITARA						
VITARA all model (3 portes/doors) Girling brake (LUCAS)	G/L	07/90 -> 12/98	733501		1345/1126	54420A60A01-5442060A01 5442086CA0
	D/R	07/90 -> 12/98	733500		1400/1181	54410A60A01-5441060A01 5441086CA0
VITARA all model (3 portes/doors)	G/L	07/90 -> 12/98	733503		1344/1113	54420A60A60-5442060A60 5442060A20
	D/R	07/90 -> 12/98	733502		1398/1170	54410A60A60-5441060A60
VITARA all model (5 portes/doors)	G/L	07/90 -> 12/98	733505		1630/1420	5442056B60
	D/R	07/90 -> 12/98	733504		1685/1475	5441056B60
VITARA (grand) all model 3 portes/doors	G/L	04/98 -> 09/05	554443	805087	1336/1073	5442065D00
	D/R	04/98 -> 09/05	554444		1390/1124	5441065D00
VITARA (grand) all model 5 portes/doors	G/L	04/98 -> 09/05	554445	805088	1575/1311	5442065D10
	D/R	04/98 -> 09/05	554446		1625/1361	5441065D10
VITARA (grand) all model 3 portes/doors	G/L	09/05 ->	554447	805089		5440264J00
	D/R	09/05 ->	554448			5440164J00
VITARA (grand) all model 5 portes/doors	G/L	09/05 ->	554449	805090		5440265J00
	D/R	09/05 ->	554450			5440165J00
WAGON R+						
WAGON R+ all model		-> 00	Not available			
WAGON R+ all model	G/L	00 -> 03	554451		1508/1300	5442083E00
	D/R	00 -> 03	653284		1507/1291	5441083E20-5440178F02
WAGON R+ all model	G/L	03->	653302	853302	1536/1281	5442084E00-4706689-9211156
	D/R	03->	653303		1530/1281	5441084E00-4706688-9211155
TALBOT						
HORIZON						
HORIZON all model	Unique Single	78 -> 86	303150		3030/625x2	521528600
SAMBA						
SAMBA all model	G/L or D/R	82 -> 86	303160		1350/640	9750175380

Véhicule Vehicle	Position	Année Year	SEIM P/n	Kit P/n	Longueur Length	OE
TOYOTA						
AURIS						
AURIS all model	Primaire Front	03/07 -> 03/10 03/10 ->	NEW 555124		340	4641002090
AURIS VtI & D-4D 90 & 126 cv (freins à disques/disc brake)	G/L	03/07 -> 03/10 03/10 ->	NEW 555125		1920/1745	4642002121
	D/R	03/07 -> 03/10 03/10 ->	NEW 555126		1892/1719	4643002121
AURIS D-4D 177 cv (freins à disques/disc brake)	G/L	03/07 -> 03/10 03/10 ->	NEW 555122		1840/1652	4642002130
	D/R	03/07 -> 03/10 03/10 ->	NEW 555123		1830/1644	4643002130
AVENSIS						
AVENSIS (T22) all model	Primaire Front	01/98 -> 05/03	733337		330	4641005020
AVENSIS (T22) all model (freins à tambours/drum brake)	G/L	01/98 -> 05/03	733339		1830	4643020700-4643005020
	D/R	01/98 -> 05/03	733338		1790	4642020590-4642005020
AVENSIS (T22) all model (freins à disques/disc brake)	G/L	09/00 -> 06/01	554452		1805/1534	4643020600
	D/R	09/00 -> 06/01	554453		1760/1493	4642020480
AVENSIS (T22) all model (freins à disques/disc brake)	G/L	07/01 -> 05/03	554455	805091	1868/1616	4643020640
	D/R	07/01 -> 05/03	554456		1824/1573	4642020520
AVENSIS II (T25) all model	Primaire Front	05/03 ->	554454		398	4641005040-4641012270
AVENSIS II (T25) all model (freins à disques/disc brake)	G/L	05/03 -> 03/04	554457	805092	1770/1473	4643005030
	D/R	05/03 -> 03/04	554458		1823/1530	4642005030
AVENSIS II (T25) all model (freins à disques/disc brake)	G/L	04/04 ->	554459		1770/1473	4643020680
	D/R	04/04 ->	554645		1823/1530	4642020570
AYGO						
AYGO all model	G/L	06/05 ->	204303	804303	1487/1243	4745Y3-464300H010
	D/R	06/05 ->	204304		1478/1235	4745Y2-464200H010
CAMRY						
CAMRY all model		82 ->	Not available			
CARINA						
CARINA AT 151 all model		84 -> 03/88	Not available			
CARINA II AT171 CT170 ST171 sans/ without ABS	Primaire Front	04/88 -> 06/92	733212		296	4641020210-4641002040 4641012250-4641020230 4641020300-4641010030 4641012160-4641012210 94857010
CARINA II AT171 1.6 ess & all model Diesel	G/L	04/88 -> 06/92	Not available		1625/1320	4643029045
	D/R	04/88 -> 06/92	Not available		1660/1350	4642029035
CARINA II ST171 2.0	G/L	04/88 -> 06/92	Not available		1610/1310	4643029055
	D/R	04/88 -> 06/92	Not available		1645/1340	4642029045
CARINA E all model AT/CT/ST 190/191	Primaire Front	07/92 ->	554460		346	4641020380
CARINA E all model AT/CT/ST 190/191 1.6 2.0D	G/L	07/92 ->	733333		1780/1500	4643020361
	D/R	07/92 ->	733334		1725/1445	4642020351
CELICA						
CELICA all model	G/L	08/85 -> 04/94	Not available		1580/1200	4643029025
	D/R	08/85 -> 04/94	Not available		1587/1200	4642029015
CELICA all model	Primaire Front	04/94 -> 10/99	733208		310	4641020420
CELICA IV ST200 all model sauf/except 4VVD	G/L or D/R	04/94 -> 10/99	733311		1653/1353	4642020410
CELICA IV ST202 all model 1.8 & 2.0 sauf/ except 4VVD	G/L	04/94 -> 10/99	733309		1665/1400	4643020520
	D/R	04/94 -> 10/99	733310		1625/1353	4642020440
CELICA V ZT23 all model	Primaire Front	11/99 -> 09/06	554461		385	4641020450

Véhicule Vehicle	Position	Année Year	SEIM P/n	Kit P/n	Longueur Lenght	OE
TOYOTA						
<i>Suite...</i>						
CELICA (suite)						
CELICA V ZZT23 all model	G/L	11/99 -> 09/06	554462		1672/1443	4643020580
	D/R	11/99 -> 09/06	554463		1707/1480	4642020460
COROLLA						
COROLLA all model 1.3 & 1.8D	Primaire Front	83 -> 05/87	733212		296	4641020210-4641002040 4641012250-4641020230 4641020300-4641010030 4641012160-4641012210 94857010
COROLLA (E9) all model 1.3 1.6 1.8D AE92 CE90 - EE90	Primaire Front	05/87 -> 09/92	733212		296	4641012160-4641012210
COROLLA (E9) all model 1.6 & 1.8D	G/L	05/87 -> 09/92	733340		1571/1247	4643012240
	D/R	05/87 -> 09/92	733315		1560/1245	4642012340
COROLLA (E9) all model 1.6 GT	G/L	05/87 -> 09/92	733317		1440/1190	4643012260
	D/R	05/87 -> 09/92	733318		1430/1180	4642012360
COROLLA STATION WAGON (E9) (break) 1.6XLI 4WD	G/L	05/87 -> 09/92	733319		1447/882	4643012281
	D/R	05/87 -> 09/92	733320		1468/798	4642012371-4642012200
COROLLA (E10) all model	Primaire Front	09/92 -> 93	Not available		360	4641012190
COROLLA (E10) all model	Primaire Front	93 -> 06/97	Not available		360	4641012190
COROLLA (E10) 1.6i	G/L	09/92 -> 06/97	554464		1450/1215	4643012290-4643012370
	D/R	09/92 -> 06/97	554465		1450/1220	4642012390
COROLLA (E10) all model 1.3 1.6 & 2.0D	G/L	09/92 -> 06/97	733323		1585/1290	4643012300-4643002040
	D/R	09/92 -> 06/97	733324		1600/1310	4642012400-4642002040 98457024-94852993
COROLLA (E11) all model LIFTBACK	G/L	07/97 -> 12/99	554464		1450/1215	4643012290-4643012370
	D/R	07/97 -> 12/99	554465		1450/1220	4642012390
COROLLA STATION WAGON (E11) (break) all model	G/L	07/97 -> 12/99	733323		1585/1290	4643012300-4643002040
	D/R	07/97 -> 12/99	733324		1600/1310	4642012400-4642002040 98457024-94852993
COROLLA (E12U) all model	Primaire Front	12/99 -> 02/02	554454		398	4641012270-4641005040
COROLLA (E12U) 1.6 16V	G/L	12/99 -> 02/02	554467		1626/1405	4643012400
	D/R	12/99 -> 02/02	554468		1688/1478	4642012490
COROLLA (E12U) all model	G/L	12/99 -> 02/02	554470		1640/1394	4643012440-4643012441 4643002090-4643002111
	D/R	12/99 -> 02/02	554471		1698/1460	4642012540-4642012541 4642002090-4642002111
COROLLA VERSO (E12J) all model	Primaire Front	01/02 -> 05/04	554469		276	464100F010
COROLLA VERSO (E12J) all model	G/L	01/02 -> 05/04	554470		1640/1394	4643012440-4643012441 4643002090-4643002111
	D/R	01/02 -> 05/04	554471		1698/1460	4642012540-4642012541 4642002090-4642002111
COROLLA VERSO ZER ZZE all model	G/L	08/08 ->	554697		1927/1705	464300F010
	D/R	08/08 ->	554698		1984/1763	464200F010
MR2						
MR2 (AW11 & SW20) all model		86 -> 99	Not available			
MR2 (ZZW30) all model	Primaire Front	99 ->	554472		268	4641017050
MR2 (ZZW30) all model	G/L	99 ->	554473		1573/1438	4643017091
	D/R	99 ->	554474		1583/1448	4642017091
PIC NIC						
PIC NIC		12/96 -> 07/01	Not available			

Véhicule Vehicle	Position	Année Year	SEIM P/n	Kit P/n	Longueur Lenght	OE
TOYOTA						
PREVIA						
PREVIA	G/L	05/00->07/007	NEW 555194		1276/1058	4643028391-4643028390
	D/R	05/00->07/007	NEW 555195		2025/1811	4642028440-4642028441
PRIUS						
PRIUS all model Hybride	G/L	03/04 -> 11/09	NEW 555127		1775/1494	4643047060
	D/R	03/04 -> 11/09	NEW 555128		1715/1438	4642047060
RAV4						
RAV4 all model 3 & 5 portes/doors	Primaire Front	07/94 -> 07/00	554560		258	4641042010
RAV4 all model 3 portes/doors	G/L	07/94 -> 07/00	733336		1345/1070	4643042010
	D/R	07/94 -> 07/00	733335		1335/1060	4642042010
RAV4 all model 5 portes/doors	G/L	07/94 -> 07/00	554475		1544/1255	4643042020
	D/R	07/94 -> 07/00	554476		1540/1255	4642042020
RAV4 II all model 3 & 5 portes/doors	Primaire Front	07/00 -> 12/05	733200		408	4641042040
RAV4 II all model 3 portes/doors	G/L	07/00 -> 12/05	554477	805096	1307/1025	4643042100
	D/R	07/00 -> 12/05	554478		1307/1025	4642042100
RAV4 II all model 3 portes/doors (freins à disques/disc brake)	G/L	07/00 -> 12/05	NEW 555129		1274/1030	4643042080
	D/R	07/00 -> 12/05	NEW 555130		1274/1030	4642042080
RAV4 II all model 5 portes/doors	G/L	07/00 -> 12/05	554479	805097	1460/1190	4643042090
	D/R	07/00 -> 12/05	554480		1460/1190	4642042090
RAV4 II all model 5 portes/doors (freins à disques/disc brake)	G/L	07/00 -> 12/05	554481	805098	1425/1180	4643042070
	D/R	07/00 -> 12/05	554482		1425/1180	4642042070
RAV4 III 5 portes/doors	Primaire Front	02/06>11/09 04/10>01/13	NEW 555189		320	4641042050
SPORTSVAN						
SPORTSVAN		85 ->	Not available			
STARLET						
STARLET		78 ->	Not available			
SUPRA						
SUPRA			Not available			
URBAN CRUISER						
URBAN CRUISER all model 177 D-CAT	G/L	04/09 ->	NEW 555131		1617/1427	4643052161-4643052210
	D/R	04/09 ->	NEW 555132		1690/1483	4642052161-4642052210
VERSO						
VERSO 132 & 147 WFi-1.26 D4D-150 &	G/L	06/09->	NEW 555190		1910/1735	464300F020
	D/R	06/09->	NEW 555191		1972/1798	464200F020
VERSO-S						
VERSO-S all model	G/L	01/11 ->	NEW 555133		1657/1434	4643052250
	D/R	01/11 ->	NEW 555134		1695/1475	4642052330
YARIS						
YARIS all model (freins à tambours/drum brake)	G/L	01/99 -> 01/01	733303	833202	1545/1355	4643052010
	D/R	01/99 -> 01/01	733302		1503/1350	4642052010
YARIS all model modèle français/french model (freins à tambours/drum brake)	G/L	01/01 -> 12/05	554485	805100	1582/1377	464300D010
	D/R	01/01 -> 12/05	554486		1552/1347	464200D010
YARIS all model (freins à disques/disc brake)	G/L	04/99 -> 12/05	554483	805099	1520/1390	4643052080
	D/R	04/99 -> 12/05	554484		1480/1345	4642052080
YARIS all model modèle français/french model (freins à tambours/drum brake)	G/L	12/05 -> 05/11	554487	805101	1556/1320	464300D050
	D/R	12/05 -> 05/11	554488		1600/1363	464200D050
YARIS all model modèle japonais/japon model (freins à tambours/drum brake)	G/L	12/05 -> 05/11	NEW 555120		1558/1348	4643052151
	D/R	12/05 -> 05/11	NEW 555121		1600/1395	4642052151
YARIS all French model (freins à disques/disc brake)	G/L	12/05 -> 05/11	554489	805102	1642/1468	464300D060
	D/R	12/05 -> 05/11	554490		1685/1511	464200D060
YARIS all Japanese model (freins à disques/disc brake)	G/L	12/05 -> 05/11	NEW 555131		1617/1427	4643052161-4643052210
	D/R	12/05 -> 05/11	NEW 555132		1690/1483	4642052161-4642052210
YARIS III 1.0 WFi 69ch-1.3 WFi 100ch-D4D 90ch (freins à tambours/drum brake)	G/L	03/11 ->	NEW 555135		1615/1372	464300D200
	D/R	03/11 ->	NEW 555136		1693/1450	464200D200

Véhicule Vehicle	Position	Année Year	SEIM P/n	Kit P/n	Longueur Lenght	OE
---------------------	----------	---------------	-------------	------------	--------------------	----

TOYOTA
Suite...
YARIS (suite)

YARIS III 1.0 VFi 69ch-1.3 VFi 100ch-D-4D 90ch (freins à disques/disc brake)	G/L	03/11 >	NEW 555192		1705/1520	464300D210
	D/R	03/11 >	NEW 555193		1775/1598	464200D210

YARIS VERSO

YARIS Verso all model (freins à tambours/drum brake)	G/L	11/99 > 04/06	733344	833343	1686/1495	4643052050
	D/R	11/99 > 04/06	733343		1625/1435	4642052050
YARIS Verso all model (freins à disques/disc brake)	G/L	08/99 > 04/06	703341	803341	1662/1528	4643052070
	D/R	08/99 > 04/06	703342		1602/1470	4642052070

VOLKSWAGEN
AMAROK PICK-UP

AMAROK PICK-UP	G/L or D/R	>19/06/11	NEW 555139		1596/1288	2H0609721A
AMAROK PICK-UP	G/L or D/R	20/06/12>	Not available		1594/1287	2H0609721C-2H0609721B

BORA & BORA VARIANT

BORA & BORA VARIANT all model avec embout hexagonal/with hexagonal endfitting sauf/except 4Motion (freins à disques/disc brake)	G/L or D/R	10/98 > Ch. 1JYV238580 10/98 > Ch. 1JYD128801 10/98 > Ch. 1JYP061676 10/98 > Ch. 1JYU008821 10/98 > Ch. 1JYB019461	553081		1693/1055	1J0609721E-1J0609721H
BORA & BORA VARIANT avec embout en forme de boule/with ball shaped endfitting sauf/except 4Motion (freins à disques/disc brake)	G/L or D/R	Ch. 1JYV238581->12/05 Ch. 1JYD128802->12/05 Ch. 1JYP061677->12/05 Ch. 1JYU008822->12/05 Ch. 1JYB019462->12/05	723362		1688/1064	1J0609721AP-1J0609721AC 1J0609721AD-1J0609721AQ 1J0609721AG-1J0609721AT 1J0609721T
BORA & BORA VARIANT 4 Motion (4x4)	G/L or D/R	10/98 > 12/05	553083		1723/1090	1J0609721R-1J0609721L 1J0609721AR

CADDY

CADDY II (9K9) all model	G/L or D/R	09/96 > 03/04	723311		1670/1120	6K9609721
CADDY II (9K9) Pick up all model	G/L or D/R	09/96 > 03/04	554646		1782/1470	6U7609721
CADDY III VAN & COMBI all model with PR OE1 code	G/L or D/R	03/04 > 07/10	Not available		1718/551	2K0609721Q-2K5609721C 2K5609721J
CADDY III VAN & COMBI all model with PR OE2 code	G/L or D/R	03/04 > 07/10	553230		1713/549	2K0609721F-2K066609721J 2K0609721E
CADDY IV all model (freins à disques/disc brake)	G/L or D/R	08/10 >	NEW 555140		1705/541	2K0609721P
CADDY IV 4MOTION 4x4 all model (freins à disques/disc brake)	G/L or D/R	08/10 >	NEW 555141		1727/561	2K0609721R-2K0609721N
CADDY IV MAXI all model (freins à disques/disc brake)	G/L or D/R	08/10 >	554492		2025/757	2K3609721B-2K3609721C
CADDY IV MAXI 4MOTION 4x4 all model (freins à disques/disc brake)	G/L or D/R	08/10 >	NEW 555142		2037/772	2K3609721G

CRAFTER

CRAFTER 30-35 & 50 empattement/wheelbase 3250 sauf châssis cabine/except chassis cabs	Primaire Front	06/06 >	554307		1454/365	2E3609701A-9064202485 -9064205085
CRAFTER 30-35 & 50 châssis cabine/chassis cabs empattement/wheelbase 3250	Primaire Front	06/06 >	554310		1361/271	2E3609701R-9064202885 -2E0609701R-9064205385
CRAFTER 30-35 & 50 empattement/wheelbase 3665 sauf châssis cabine/except chassis cabs	Primaire Front	06/06 >	554308		1853/365	2E0609701L-9064202285
CRAFTER 30-35 & 50 châssis cabine/chassis cabs empattement/wheelbase 3665	Primaire Front	06/06 >	554311		1758/271	2E0609701P-9064202685 -9064205485
CRAFTER 30-35 & 50 empattement/wheelbase 4325 sauf châssis cabine/except chassis cabs	Primaire Front	06/06 >	554309		2509/365	2E0609701M-9064202385 -9064205285-A9064205285 A9064202385
CRAFTER 30-35 & 50 châssis cabine/chassis cabs empattement/wheelbase 4325	Primaire Front	06/06 >	554312		2415/271	2E0609701Q-9064202785 -9064205585
CRAFTER 30-35	G/L or D/R	06/06 >	554313		1677/1405	2E0609701AG-2E0609701J 9064202085-9064206885

Véhicule Vehicle	Position	Année Year	SEIM P/n	Kit P/n	Longueur Lenght	OE
VOLKSWAGEN Suite...						
CRAFTER (suite)						
CRAFTER 50 roues simples/simple wheels	G/L or D/R	06/06 ->	554732		1394/1065	2E0609702B-9064204485 2E0609701AR-9064207085 A9064207085-A9064204485 A9064203085-2E0609701T 9064203085
CRAFTER 50 roues jumelées/double wheels	G/L or D/R	06/06 -> 09	NEW 555035			2E0609701AA-2E0609702C A9064207185-9064207185 A9064204585-A9064203185
EOS						
EOS (1F7 & 1F8) all model	G/L or D/R	04/06 -> 01/11 ->	554417		1447/805	1K0609721BB-1K0609721AA -1K0609721AF-1K0609721T
FOX						
FOX all model (freins à tambours/drum brake)	G/L or D/R	06/05 ->	553223	853223	1580/918	6Q0609721M-6Q0609721B 6Q0609721H
FOX all model (freins à disques/disc brake)	G/L or D/R	06/05 ->	554419		1645/1043	6Q0609721K-6Q0609721L 6Q0609721F
GOLF I & II						
GOLF I all model (freins à tambours/drum brake)	G/L or D/R	08/74 -> 10/83	550120	850120	1705/1020	171609721BC
GOLF I Cabriolet/convertible (freins à tambours/drum brake)	G/L or D/R	08/74 -> 11/93	550120	850120	1705/1020	171609721BC
GOLF II all model (freins à tambours/drum brake)	G/L or D/R	01/84 -> 06/92	550140	850140	1760/1088	191609721
GOLF II all model (freins à tambours/drum brake)	G/L or D/R	01/84 -> 06/92	553000	853000	1527/1090	191609721E
GOLF II all model sauf/except Synchro (freins à disques/disc brake)	G/L or D/R	01/84 -> 06/92	550240	850240	1801/1180	191609721A
GOLF II all model sauf/except Synchro (freins à disques/disc brake)	G/L or D/R	01/84 -> 06/92	553030	853030	1620/1220	191609721F
GOLF II Synchro (4x4) (freins à disques/disc brake)	G/L or D/R	01/84 -> 06/92	Not available		1570/1080	191609721C
GOLF III						
GOLF III 1.4i-1.6i-1.8i-1.9D-1.9TD-1.9GTD-1.9 TDI 90cv (freins à tambours/drum brake)	G/L or D/R	01/92 -> Ch. 1HS037799	553010	853010	1500/937	1H0609721-1HM0609721
GOLF III 1.4i-1.6i-1.8i-1.9D-1.9TD-1.9GTD-1.9 TDI 90cv (freins à tambours/drum brake)	G/L or D/R	Ch. 1HS037528->12/97	554502	805107	1498/935	1H0609721D
GOLF III 1.9TDI 110 cv (freins à disques/disc brake)	G/L or D/R	08/96 -> 12/97	553160	853160	1620/1095	1H0609721E
GOLF III 2.0 GTI-2.0 GTI 16v & 2.8 VR6 (freins à disques/disc brake)	G/L or D/R	01/92 -> Ch. 1HS037799	553040	853040	1610/1100	1H0609721A-1HM609721A -535609721A
GOLF III 2.0 GTI-2.0 GTI 16v-2.8 VR6 (freins à disques/disc brake)	G/L or D/R	Ch. 1HS037528->12/97	553160	853160	1620/1095	1H0609721E
GOLF III cabriolet/convertible all model (freins à tambours/drum brake)	G/L or D/R	01/94 -> Ch. 1ES005031	553010	853010	1500/937	1H0609721-1HM0609721
GOLF III cabriolet/convertible all model (freins à tambours/drum brake)	G/L or D/R	Ch. 1ES005032->04/98	554502	805107	1498/935	1H0609721D
GOLF III cabriolet/convertible all model (freins à disques/disc brake)	G/L or D/R	01/94 -> 12/97	553160	853160	1620/1095	1H0609721E
GOLF III Synchro (freins à tambours/drum brake)	G/L or D/R	01/92 -> 12/97	553140	853140	1590/940	1H0609721B
GOLF III Synchro (freins à disques/disc brake)	G/L or D/R	01/92 -> 12/97	553150	853150	1600/1000	1H0609721C
GOLF IV						
GOLF IV all model avec embout hexagonal/with hexagonal end-fitting sauf/except 4Motion (freins à disques/disc brake)	G/L or D/R	01/98->06/99	553081		1693/1055	1J0609721E-1J0609721H
GOLF IV all model avec embout en forme de boule/with ball shaped end-fitting sauf/except 4Motion (freins à disques/disc brake)	G/L or D/R	08/99->05/04	723362		1688/1064	1J0609721AP-1J0609721AC 1J0609721AD-1J0609721AQ 1J0609721AG-1J0609721AT 1J0609721T

Véhicule Vehicle	Position	Année Year	SEIM P/n	Kit P/n	Longueur Lenght	OE
VOLKSWAGEN						
GOLF IV (suite)						
GOLF IV 1.8 4Motion-2.3 V5 4Motion-2.8 V6 4Motion-1.9TDI 4Motion	G/L or D/R	01/98 -> 11/04	553083		1723/1090	1J0609721R-1J0609721L -1J0609721AR
GOLF V-GOLF PLUS & CROSS GOLF						
GOLF V & GOLF V VARIANT all model	G/L or D/R	11/03 -> Ch. 1K6-620000	553084		1447/807	1K0609721BE-1K0609721Q 1K0609721S
GOLF V & GOLF V VARIANT all model	G/L or D/R	Ch. 1K6-620001->10/08	554417		1447/805	1K0609721BB-1K0609721AA- 1K0609721AF-1K0609721T
GOLF PLUS	G/L or D/R	11/03 -> Ch. 1K6-570000	553084		1447/807	1K0609721BE-1K0609721Q- 1K0609721S
GOLF PLUS	G/L or D/R	Ch. 1K6-570001->10/08	554417		1447/805	1K0609721BB-1K0609721AA- 1K0609721AF-1K0609721T
CROSS GOLF all model	G/L or D/R	03/07 -> 12/07	554417		1447/805	1K0609721BB-1K0609721AA- 1K0609721AF-1K0609721T
GOLF VI						
GOLF VI all model	G/L or D/R	10/08 ->	554417		1447/805	1K0609721BB-1K0609721AA 1K0609721AF-1K0609721T
JETTA						
JETTA I all model (freins à tambours/drum brake)	G/L or D/R	08/74 -> 10/83	550120	850120	1705/1020	171609721BC
JETTA II all model (freins à tambours/drum brake)	G/L or D/R	10/83 -> 88	550140	850140	1760/1088	191609721
JETTA II all model avec/with ABS sauf/except Synchro GTI & G60 (freins à disques/disc brake)	G/L or D/R	10/83 -> 88	553020	853020	1840/1220	191609721D
JETTA II all model avec/with ABS sauf/except Synchro GTI & G60 (freins à disques/disc brake)	G/L or D/R	10/83 -> 88	550240	850240	1801/1180	191609721A
JETTA II all model (freins à tambours/drum brake)	G/L or D/R	88 -> 12/91	553000	853000	1527/1090	191609721E
JETTA II all model avec/with ABS sauf/except Synchro GTI & G60 (freins à disques/disc brake)	G/L or D/R	88 -> 12/91	553030	853030	1620/1220	191609721F
JETTA II GTI & G60 sauf/except Synchro (freins à disques/disc brake)	G/L or D/R	10/83 -> 12/91	553040	853040	1610/1100	1H0609721A-1HM609721A -535609721A
JETTA II all model Synchro	G/L or D/R	86 -> 12/91	Not available			191609721H-191609721K
JETTA III (1K2) all model	G/L or D/R	11/03 -> Ch. 1K6-620000	553084		1447/807	1K0609721BE-1K0609721Q 1K0609721S
JETTA III (1K2) all model	G/L or D/R	Ch. 1K6-620001-> 10/08	554417		1447/805	1K0609721BB-1K0609721AA 1K0609721AF-1K0609721T
JETTA IV (162) all model	G/L or D/R	01/11 ->	NEW 555143		1598/827	5C0609721D
KOMBI						
KOMBI all model		01/70 -> 12/91	Not available			
LT 28-31-35-40-45						
LT 28-31-35-40-45		01/75 -> 04/96	Not available			
LT 28 empattement/wheelbase 3000 avec roues simples/with simple wheels	Primaire Front	09/96 ->	554293		1435/285	2D0609701-9014202085
LT 28 empattement/wheelbase 3550 avec roues simples/with simple wheels	Primaire Front	09/96 ->	554294		1990/285	2D0609701A-9014202185
LT 28 empattement/wheelbase 4025 avec roues simples/with simple wheels	Primaire Front	09/96 ->	554295		2460/285	2D0609701B-9014202285
LT 28 all model avec roues simples/with simple wheels	G/L or D/R	09/96 ->	554296		1515/1330	2D0609721-9014201885
LT 35 empattement/wheelbase 3550 avec roues jumelées/with double wheels	Primaire Front	09/96 ->	554301		1970/285	2D0609701C-9044200385
LT 35 empattement/wheelbase 4025 avec roues jumelées/with double wheels	Primaire Front	09/96 ->	554302		2440/285	2D0609701D-9044200485
LT 35 all model	G/L or D/R	09/96 ->	554296		1515/1330	2D0609721-9014201885
LT 46 empattement/wheelbase 3550 avec roues jumelées/with double wheels	Primaire Front	09/96 ->	554302		2440/285	2D0609701D-9044200485
LT 46 empattement/wheelbase 4025 avec roues jumelées/with double wheels	G/L	09/96 ->	554303		1525/1350	2D0609721A-9044200185
	D/R	09/96 ->	554304		1525/1350	2D0609722-9044200285

Véhicule Vehicle	Position	Année Year	SEIM P/n	Kit P/n	Longueur Lenght	OE
VOLKSWAGEN						
LUPO						
LUPO (freins à tambours/drum brake)	G/L or D/R	10/98 -> 06/05	553200	853200	1392/798	6X0609721H-6X0609721F
LUPO (freins à disques/disc brake)	G/L or D/R	10/98 -> 06/05	553210	853210	1500/970	6X0609721E-6X0609721D
MULTIVAN						
MULTIVAN all model		03/96 -> 05/03	Not available			
MULTIVAN V (7HM, 7HN, 7HF, 7EF, 7EM, 7EN) all model	G/L or D/R	06/03 ->	554519	805114	1297/1005	7H0609701D
NEW BEETLE						
NEW BEETLE all model avec embout hexagonal/ with hexagonal end-fitting (freins à disques/ disc brake)	G/L or D/R	01/99 -> 1CY414 262 01/99 -> 9CY607008	553081		1693/1055	1J0609721E-1J0609721H
NEW BEETLE 1.4 75cv-1.6 102cv-1.8 Turbo-2.0 -2.3V5-1.9 TDI 90, 100 & 105cv avec embout en forme de boule/with ball shaped end-fitting (freins à disques/disc brake)	G/L or D/R	1CY414263 -> 10/11 9CY607009->10/11	723362		1688/1064	1J0609721AP-1J0609721AC 1J0609721AD-1J0609721AQ 1J0609721AG-1J0609721AT -1J0609721T
NEW BEETLE II 1.2 TSI 105cv-1.4 TSI 160cv- 1.6 TDI 105cv-2.0 TDI 140cv	G/L or D/R	09/11->	NEW 555196		1482/809	5C0609721AN-5C0609721AM
NEW BEETLE II 2.0 TSI 200cv Sport	G/L or D/R	09/11->	NEW 555197		1498/827	5C0609721AJ
PASSAT						
PASSAT II all model	Unique Single	81 -> 88	550160		2586/2x1047	321609721C
PASSAT III 1.6 1.8 T DIESEL (freins à tambours/drum brake)	G/L or D/R	88 -> 93	553050	853050	1628/1030	357609721
PASSAT III all model (freins à tambours/drum brake)	G/L or D/R	93 -> Ch. 3AV300000	553220		1620/890	3A0609721-3A0609721B
PASSAT III all model (freins à disques/disc brake)	G/L or D/R	88 -> 93	553060	853060	1740/1180	357609721A-357609721D 357609721E
PASSAT III all model (freins à disques/disc brake)	G/L or D/R	93 -> 96	553171		1725x1040	3A0609721A-3A0609721C
PASSAT III all model Synchro (4x4)	G/L or D/R	88 -> 96	554512		1718/1165	357609721C
PASSAT IV all model	G/L	10/96 -> 03/05	554513	805111	1890/1577+ 158	3B0609721F-3B0609721L -3B0609721S-3B0609721AC
	D/R	10/96 -> 03/05	554514		1890/1577+ 158	3B0609722F-3B0609722K -3B0609722N-3B0609722Q
PASSAT IV 4MOTION all model	G/L or D/R	10/96 -> 03/05	554515	805112	1835/1660	3B0609721K
PASSAT V all model		03/05 ->	Not available			
POLO						
POLO I / DERBY (861/2) all model	Primaire Front	75 -> 81	554516		794	861609729
POLO I / DERBY (861/2) all model	Unique Single	75 -> 81	550040		1960/605x 360	861609721AB
POLO II / DERBY (86C) all model	Primaire Front	11/81 -> Ch. E200000	554516		794	861609729
POLO II / DERBY (86C) all model	Unique Single	11/ 81 -> Ch. E200000	550040		1960/605x 360	861609721AB
POLO II / DERBY (86C) all model	Primaire Front	Ch. E200001->10/94	550250		1608/1088	867609721
POLO II / DERBY (86C) all model	G/L or D/R	Ch. E200001->10/94	550290	853290	640/370	867609701
POLO III (6N1) all model (freins à tambours/drum brake)	G/L or D/R	10/94 -> 11/99	554517	805113	1512/953	6N0609721F-6N0609721J
POLO III (6N1) VARIANT all model	G/L or D/R	11/97 -> 11/99	553120	853120	1510/970	6N0609721G-6N0609721A 6N0609721B-6N0609721E
POLO III (6N2) all model (freins à tambours/drum brake)	G/L or D/R	11/99 -> 12/01	723360	823360	1515/955	6N0609721K
POLO III (6N2) all model (freins à disques/ disc brake)	G/L or D/R	11/99 -> 12/01	723361	823361	1641/1132	6N0609721M-6N0609721H 6N0609721L
POLO CLASSIC (6KV2) sans/without ABS	G/L or D/R	03/96 -> 12/01	554517	805113	1512/953	6N0609721F-6N0609721J

Véhicule Vehicle	Position	Année Year	SEIM P/n	Kit P/n	Longueur Lenght	OE
VOLKSWAGEN						
						<i>Suite...</i>
POLO (suite)						
POLO CLASSIC (6KV2) avec/with ABS	G/L or D/R	03/96 -> 12/01	553120	853120	1510/970	6N0609721G-6N0609721A 6N0609721B-6N0609721E
POLO CLASSIC (6KV2) all model (freins à disques/disc brake)	G/L or D/R	03/96 -> 12/01	723361	823361	1641/1132	6N0609721M-6N0609721H 6N0609721L
POLO IV (9N_) all model (freins à tambours/drum brake)	G/L or D/R	12/01-> 09/09	553223	853223	1580/918	6Q0609721M-6Q0609721B 6Q0609721H
POLO IV (9N_) all model (freins à disques/disc brake)	G/L or D/R	12/01-> 09/09	554419		1645/1043	6Q0609721K-6Q0609721L 6Q0609721F
POLO IV CROSS all model (freins à tambours/drum brake)	G/L or D/R	06/06 -> 09/09	554418		1581/916	6Q0609721N-6Q0609721J 6Q0609721D
POLO IV CROSS all model (freins à disques/disc brake)	G/L or D/R	06/06 -> 09/09	554419		1645/1043	6Q0609721K-6Q0609721L
POLO V 1.2-1.4 85 cv-1.2 75cv (freins à tambours/drum brake)	G/L or D/R	09/09 ->	554420		1588/923	6Q0609721F 6R0609721B
POLO V 1.2TSI 105cv 1.4i 85cv-1.4TSI 150cv- 1.6 16v-1.6 TDI 90 & 105cv (freins à disques/disc brake)	G/L or D/R	09/09 ->	554421	805083	1642/1044	6C0609721-6R0609721C
POLO V CROSS 1.4 85cv (freins à tambours/drum brake)	G/L or D/R	06/10 ->	554420		1588/923	6R0609721B
POLO V CROSS 1.2TSI 105cv 1.4i 85cv- 1.4TSI 150cv-1.6 16v-1.6 TDI 90 & 105cv (freins à disques/disc brake)	G/L or D/R	06/10 ->	554421	805083	1642/1044	6C0609721-6R0609721C
SHARAN						
SHARAN all model	Intermediate	10/95 -> 09/10	652151		653	7M3711472-7M0711472A 1013482
SHARAN all model	G/L or D/R	10/95 -> 12/03	553180	853180	1230/1130	7M3609701C-7M0609701B 95VW2A603AC
SHARAN V6 TIPTRONIC & 4MOTION	G/L or D/R	06/00 -> 12/03	553226		1320/1156	7M3609701D-7M3609701
SCIROCCO III (137)						
SCIROCCO III (137) all model	G/L or D/R	07/08 ->	554417		1447/805	1K0609721BB-1K0609721AA 1K0609721AF-1K0609721T
TRANSPORTER						
TRANSPORTER 1.6 2.0 sauf/except 4x4	G/L or D/R	79 -> 06/90	553100	853100	1455/960	251609701A-251609701B 251609701C
TRANSPORTER 4x4	G/L or D/R	79 -> 06/90	Not available			
TRANSPORTER T4 all model (freins à tambours/drum brake)	G/L or D/R	07/90 -> 03/96	553221	853221	830/510	701609701
TRANSPORTER T4 all model + 4x4 (freins à disques/disc brake)	G/L or D/R	03/96->Ch.70W120000	554518		949/715	7D0609701
TRANSPORTER T4 all model + 4x4 (freins à disques/disc brake)	G/L or D/R	Ch.70W120001->06/03	553225	853225	953/720	7D0609701A-7D0609701B 7D0609701D-7D0609701E 7D0609701F
TRANSPORTER T5 all model sauf/except 4x4	G/L or D/R	06/03 -> 07/04	554519	805114	1297/1005	7H0609701D
TRANSPORTER T5 Fourgon all model & CARAVELLE 2.5 TDI sauf/except 4x4	G/L or D/R	06/03 -> 07/04	554520	805115	1270/1000	7H8609701G
TRANSPORTER T5 all model & CARAVELLE 4x4 châssis normal/normal wheelbase	G/L or D/R	07/04 ->	554522	805117	1650/1285	7H1609701F
TRANSPORTER T5 all model 4MOTION 4x4 châssis court/short wheelbase	G/L or D/R	07/04 ->	NEW 555144		1631/1273	7E0609701C
TRANSPORTER T5 all model 4MOTION 4x4 châssis long/long wheelbase	G/L or D/R	07/04 ->	554523	805118	2015/1648	7H3609701H
TRANSPORTER T5 4MOTION 4x4 châssis cabine/chassis cabs	G/L or D/R	07/04 ->	554521	805116	2015/1648	7J3609701

Véhicule Vehicle	Position	Année Year	SEIM P/n	Kit P/n	Longueur Lenght	OE
VOLKSWAGEN						
TOURAN						
TOURAN (1T1-1T2) all model (Mod PR: T9G T53 TG58 T71 & T72)	G/L or D/R	03/03 -> 12/06	553229		1563/898	1T0609721F-1T0609721G
TOURAN (1T1-1T2) all model	G/L or D/R	03/03->Ch.1T6-120 000	554524	805119	1561/896	1T0609721H-1T0609721J
TOURAN (1T1-1T2) all model	G/L or D/R	Ch.1T6-120 001->09/10	554525	805120	1561/896	1T0609721L-1T0609721K
TOURAN (1T1-1T2) all model 2.0 ECOFUEL (GPL)	G/L or D/R	12/06 -> 09/10	554526	805121	1610/940	1T0609721M
TOURAN II (1T3)	G/L or D/R	09/10 ->	554525	805120	1561/896	1T0609721L-1T0609721K
TOUAREG						
TOUAREG all model	Primaire Front	11/02 -> 12/06	554527		1973/1764	7L0721556
TOUAREG all model	Primaire Front	01/07 -> 04/10	554649		1890/1685	7L0721556B-7L0609556B
TOUAREG all model	G/L or D/R	11/02 -> 04/10	554528	805122	1750/1631	7L0609721A - 95542414110
UPI						
UPI all model	G/L or D/R	->21/11/11	NEW 555114		1528/820	1S0609721A
UPI all model	G/L or D/R	21/11/11->	NEW 555115		1518/810	1S0609721C
VENTO						
VENTO 1.4i-1.6i-1.8i-1.9D-1.9TD-1.9GTD-1.9 TDI 90cv (freins à tambours/drum brake)	G/L or D/R	01/92->Ch.1HS037799	553010	853010	1500/937	1H0609721-1HM0609721
VENTO 1.4i-1.6i-1.8i-1.9D-1.9TD-1.9GTD-1.9 TDI 90cv (freins à tambours/drum brake)	G/L or D/R	Ch.1HS037528->12/97	554502	805107	1498/935	1H0609721D
VENTO 1.9TDI 110 cv (freins à disques/disc brake)	G/L or D/R	08/96 -> 12/97	553160	853160	1620/1095	1H0609721E
VENTO 2.0 GTI-2.0 GTI 16v & 2.8 VR6 (freins à disques/disc brake)	G/L or D/R	01/92 ->Ch.1HS037799	553040	853040	1610/1100	1H0609721A-1HM609721A -535609721A
VENTO 2.0 GTI-2.0 GTI 16v-2.8 VR6 (freins à disques/disc brake)	G/L or D/R	Ch.1HS037528-> 12/97	553160	853160	1620/1095	1H0609721E
VOLVO						
240 340 360 440 460 480 740 760 780 850 940 96						
240 340 360 440 460 480 740 760 780 850 940 960 all model			Not available			
C30						
C30 all model	Primaire Front	12/06 -> 10/09 ->	554109		336	30760198
C30 all model	Unique Single	12/06 -> 10/09 ->	554529		1816/1702+ 1860/1745	31262940-30742642-31257680
C70						
C70 all model y compris/include coupé & cabriolet/convertible	G/L or D/R	09/97 -> 11/05	554530		1695/1515	8600755-9475286
C70 II all model y compris/include coupé & cabriolet/convertible	Unique Single	01/06->12/09	554529		1816/1702+ 1860/1745	31262940-30742642-31257680
S40 V40 & V50						
S40 / V40 all model	G/L	03/96 -> 00	554532		1590/1468	30850022-30884534-30863449
	D/R	03/96 -> 00	554533		1590/1468	30850023-30863450-30884536
S40 / V40 all model	G/L	00 -> 04/04	554534		1620/1472	30884537-30621298-30644115
	D/R	00 -> 04/04	554535		1620/1472	30884538-30621299-30644116
S40 / V50 all model	Primaire Front	05/04 -> 07/05	554536		245	3345598
S40 / V50 all model	Unique Single	05/04 -> 07/05	554537		1830/1700+ 1876/1745	30714215-4N512A603BA
S40 / V50 all model S40 II / V50 II all model	Primaire Front	08/05 -> 06/07->	554109		336	30760198
S40 / V50 all model S40 II / V50 II all model	Unique Single	08/05 -> 06/07->	554529		1816/1702+ 1860/1745	31262940-30742642-31257680

Véhicule Vehicle	Position	Année Year	SEIM P/n	Kit P/n	Longueur Length	OE
VOLVO						
S60						
S60 all model	Primaire Front	09/00 >	554539		320	9191484
S60 all model sauf/except AWD (4x4)	G/L or D/R	09/00 >	554540		1923/1847	30665093-9173146-30714831 31257604
S60 all model AWD (4x4)	G/L or D/R	09/00 >	554541		1958/1867	8646151-30793821
S70 & V70						
S70-V70 all model sauf/except AWD (4x4)	G/L or D/R	12/96 > 11/00	554542		1670/1480	35464905-9209756
S70-V70 AWD (4x4) all model	G/L or D/R	12/96 > 11/00	554543		2165/1890	9209757-9485386
S70-V70 all model	Primaire Front	11/00 > 03	554539		320	9191484
S70-V70 all model sauf/except AWD (4x4)	G/L or D/R	11/00 > 03	554545		1962/1880	3524199-30793819-30793825
S70-V70 AWD (4x4) all model	G/L or D/R	11/00 > 03	554546		1993/1912	9434192-9485316-30714129 30742524-30793820
S80						
S80 all model	Primaire Front	11/00 >	554539		320	9191484
S80 all model sauf/except GPL & AWD (4x4) 30742524-30793820	G/L or D/R	07/98 > 04	554546		1993/1912	9434192-9485316-30714129
S80 all model sauf/except GPL & AWD (4x4) 30742524-30793820	G/L or D/R	05 >	554546		1993/1912	9434192-9485316-30714129
S80 AWD (4x4) all model sauf/except GPL	G/L or D/R	07/98 > 06	554547		2024/1934	3524200
S90 & 960						
S90 / 960	Primaire Front	12/96 >	554548		2065/1825	91409790
S90 / 960	G/L	12/96 >	554548		2065/1825	91409790
S90 / 960	D/R	12/96 > Ch. n°54468	554549		753/361	13872577-68190339
S90 / 960	D/R	Ch. n°54469 >	554550		750/360	9157231
XC 70 & XC 90						
XC70 all model	Primaire Front	98 > 03	554539		320	9191484
XC70 all model	G/L or D/R	98 > 03	554546		1993/1912	9434192-9485316-94341922
XC70 / XC90 all model	Primaire Front	03 >	554551		1985/1828	30714012
XC70 / XC90 all model	G/L	03 >	554552		2160/2087	30681684

2014-2015

Tirettes de capot



Bonnet cables
Commandi apertura
cofano
Mando capo
Motorhaubenzüge

Sommaire Contents

CITROËN.....	167
FIAT	167
MERCEDES	167
OPEL.....	167
PEUGEOT	167
RENAULT	168
VOLKSWAGEN	168

Tirettes de capot

Comment utiliser l'onglet tirette de capot ?

How to use bonnet cable tab ?

Véhicule Vehicle	Année Year	SEIM P/n	Longueur Lenght	OE
AUDI				
BERLINGO				
BERLINGO I (M49)	06 /96 -> OPR 07188 (07/96)	Not available	1730/1680	7937E1-9621290280
BERLINGO I (M49)	OPR 07189 (08/96) -> 11/02	Not available	1750/1700	7937E9-9620634180
BERLINGO II (M59)	11/02 -> 04/08	554651	2130/2080	7937J7-9646626280
BERLINGO III (M9)	05/08 ->	554652		7937Q8
C4 all model				
C4 all model	11/04 -> OPR 10894	Not available		7937L0
C4 all model	OPR 10895 (07/94) -> 05/95	554651		7937L0
JUMPER all model				
JUMPER all model	02/94 ->	122103	1730/1540	7937A5
SAXO				
SAXO all model		122091	1450/1400	7937C6
XANTIA				
XANTIA all model (Côté poignée/handle side)	03/93->09/02	122092	1500/1450	96132380-9613238080
XANTIA all model (Côté capot/hood side)	03/93->09/02	Not available	307	96103782-9610378280
FIAT				
DUCATO				
DUCATO all model	02/94 ->	122103	1730/1540	7937A5
IDEA				
IDEA all model	01/04 ->	114119		51790283-46844599
PANDA				
PANDA all model	81 -> 08/03	114105	1350/1500	7556131-4404120
MERCEDES				
SPRINTER				
SPRINTER (901) 208 CDI-211 CDI-213 CDI		NEW 555146		A9017500359
SPRINTER (902) 214-208 CDI-211 CDI-213 CDI-216 CDI		NEW 555146		A9017500359
SPRINTER (903) 314-308 CDI-311 CDI-313-316 CDI		NEW 555146		A9017500359
SPRINTER (904) 414-408 CDI-411 CDI-413 CDI-416 CDI		NEW 555146		A9017500359
SPRINTER (905) 616 CDI		NEW 555146		A9017500359
SPRINTER (906) 224-209 CDI-211 CDI-213 CDI-215 CDI-218 CDI-324-309 CDI-311 CDI-313 CDI-315 CDI-318 CDI-524-509 CDI-511 CDI-515 CDI-518 CDI		Not available		A9068800059
SPRINTER (909) 308-408 CDI		NEW 555146		A9017500359
OPEL				
CORSA				
CORSA A all model	-> 02/93	122139	1480	1178447
CORSA B all model	03/93 -> 10/00	114103	1480	1178462
TIGRA				
TIGRA B all model	09/94 -> 09/00	114103	1480	1178462
VECTRA				
VECTRA A all model	09/88 -> 06/95	122140	1650	1178451
VECTRA B all model	11/95 -> 06/02	122167	1730	6178437

 Modèle
 Model

 Date de fabrication
 Date of manufacture

 Référence Seim
 Seim P/n

 Longueur en mm
 Lenght in mm

 Référence d'origine
 OE P/n

Pour toutes questions notre service technique est disponible
du lundi au vendredi de 8H00 à 12H15 et de 13H15 à 17H00
Tél. 04 74 46 07 36

Véhicule Vehicle	Année Year	SEIM P/n	Longueur Lenght	OE
CITROËN				
BERLINGO				
BERLINGO I (M49)	06 /96 ->OPR 07188 (07/96)	Not available	1730/1680	7937E19621290280
BERLINGO I (M49)	OPR 07189 (08/96)> 11/02	Not available	1750/1700	7937E99629634180
BERLINGO II (M59)	11/02 -> 04/08	554651	2130/2080	7937J79646626280
BERLINGO III (B9)	05/08 ->	554652		7937Q8
C4 all model				
C4 all model	11/04->OPR 10894	Not available		7937L0
C4 all model	OPR 10895->07/08	NEW 555145		7937P09681183280
C25				
C25 all model		042020	1625/1378	793758-793759
JUMPER				
JUMPER all model	02/94 ->	122103	1730/1540	7937A5
SAXO				
SAXO all model		122091	1450/1400	7937C6
XANTIA				
XANTIA all model (Côté poignée/handle side)	03/93->09/02	122092	1500/1450	96132380-9613238080
XANTIA all model (Côté capot/hood side)	03/93->09/02	Not available	307	96103782-9610378280
FIAT				
DUCATO				
DUCATO all model	02/94 ->	122103	1730/1540	7937A5
IDEA				
IDEA all model	01/04 ->	114119		51790283-46844599
PANDA				
PANDA all model	81 -> 08/03	114105	1350/1500	7556131-4404120
MERCEDES				
SPRINTER				
SPRINTER (901) 208 CDI-211 CDI-213 CDI		NEW 555146		A9017500359
SPRINTER (902) 214-208 CDI-211 CDI-213 CDI-216 CDI		NEW 555146		A9017500359
SPRINTER (903) 314-308 CDI-311 CDI-313-316 CDI		NEW 555146		A9017500359
SPRINTER (904) 414-408 CDI-411 CDI-413 CDI-416 CDI		NEW 555146		A9017500359
SPRINTER (905) 616 CDI		NEW 555146		A9017500359
SPRINTER (906) 224-209 CDI-211 CDI-213 CDI-215 CDI-218 CDI-324-309 CDI-311 CDI-313 CDI-315 CDI-318 CDI-524-509 CDI-511 CDI-515 CDI-518 CDI		Not available		A9068800059
SPRINTER (909) 308-408CDI		NEW 555146		A9017500359
OPEL				
CORSA				
CORSA A all model	-> 02/93	122139	1480	1178447
CORSA B all model	03/93 -> 10/00	114103	1480	1178462
TIGRA				
TIGRA B all model	09/94 -> 09/00	114103	1480	1178462
VECTRA				
VECTRA A all model	09/88 -> 06/95	122140	1650	1178451
VECTRA B all model	11/95 -> 06/02	122167	1730	6178437
PEUGEOT				
104				
104 all model	01/76 -> 06/88	042020	1625/1378	793716
204				
204 all model	65 -> 76	042020	1625/1378	793716
205				
205 all model	03/83 -> 01/90	114102	1720/1570	793765-9252199880

Véhicule Vehicle	Année Year	SEIM P/n	Longueur Length	OE
PEUGEOT Suite...				
205 all model	01/90 -> 01/91	Not available	1660/1540	793791-9608344680
205 all model	01/91 -> 12/98	Not available	1660/1540	793796-9612804080
304				
304 all model	09/69 -> 09/79	042020	1625/1378	793716
309				
309 all model (sans poignée/without handle)	10/85 -> 12/93	063590	1660/1500	793775
404				
404 all model	05/60 -> 10/75	042020	1625/1378	793716
405				
405 all model	07/87 -> Ch. 70434119	Not available	1350	793778
405 all model	Ch. 70434120 -> 03/95	Not available	1350	793797
405 all model	04/95 -> 10/96	Not available	1770	7937C5
406				
406 all model	10/95 -> 04/99	114092	1730/1690	7937C1
406 all model sauf coupé	05/99 -> 04/04	Not available	2030/1980	7937F5
406 Coupé	10/95 -> 12/04	114092	1730/1690	7937C1
504				
504 all model	09/68 -> 96	042020	1625/1378	793716
505				
505 all model	07/85 -> 92	062223	1430/1230	793774
604				
604 all model	09/75 -> 07/85	042020	1625/1378	793716
BOXER				
BOXER all model	02/94 ->	122103	1730/1540	7937A5
J5				
J5 all model	09/81 -> 91	042020	1625/1378	793758-793759
J7				
J7 all model	07/83 -> 91	042020	1625/1378	793758-793759
PARTNER				
PARTNER I (M49)	06/96 -> OPR 07188 (07/96)	Not available	1730/1680	7937E1-9621290280
PARTNER I (M49)	OPR 07189 (08/96) -> 11/02	Not available	1750/1700	7937E9-9629634180
PARTNER II (M59)	11/02 -> 04/08	554651	2130/2080	7937J7-9646626280
PARTNER III (B9)	05/08 ->	554652		7937Q8
RENAULT				
R5				
R5 all model	07/79 -> 06/86	054500	867/807	7701348950
R9 & R11				
R9 & R11 all model	07/81 -> 06/89	114100	1240/1190	7704002225
R18 et FUEGO				
R18 all model & FUEGO		054140	1788/1648	7701348670
VOLKSWAGEN				
GOLF				
GOLF II	9/83 ->	114109	1676/1733	192823531
GOLF III	94 ->	122142	1800/1760	1H1823531
GOLF IV all model	10/98 -> 12/05	Not available	1810/1780	1J1823531B-1J1823531C
JETTA				
JETTA II	10/83 -> 06/92	114109	1676/1733	192823531
LUPO				
LUPO	10/98 -> 06/05	122170	1750/1710	6X1721555A-6X1823531B
POLO				
POLO I (86C/2) all model	11/91 -> 10/90	Not available	1660/1560	867823531A
POLO II (86C) all model	10/90 -> 06/94	122143	1620/1580	867823531B
POLO III (6N1) all model	De10/94 -> 11/01	122174		6N1823531
VENTO				
VENTO all model	94 ->	122142	1800/1760	1H1823531

2014-2015

Tirettes de starter



Shoke cables
Cavi starter
Mando starter
Shokerseil

Sommaire Contents

CITROËN.....	171
FIAT	171
PEUGEOT	171
RENAULT	171
SEAT	171
TALBOT	171

Comment utiliser l'onglet tirette de starter ?

How to use shoke cable tab ?

Tirettes de starter
Shoke cables

Véhicule Vehicle	Année Year	SEIM P/n	Longueur Lenght	OE
CITROËN				
AX				
AX all model sauf/ SPORT	09/86 > OPR 05284 (05/91)	Not available	1320/1220	06010705
AX all model sauf SPORT	OPR 05285 (06/91) > 06/98	063641	1570/1500	95613456
AX SPORT	09/86 > OPR 05284 (05/91)	Not available		95638605
AX SPORT	OPR 05285 (06/91) > 06/98	Not available		96080078

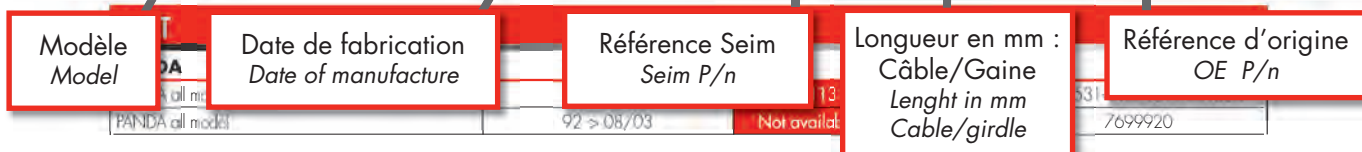

PEUGEOT				
205				
205 all model sauf/except automatic	03/83 > 07/87	061990	930/850	166011-166013
205 all model sauf/except automatic	07/87 > 12/98	Not available	1298/1445	166071

RENAULT				
CLIO				
CLIO all model	06/90 > 02/98	064232	1710/1620	7700803223
R4				
R4 all model	79 > 12/92	Not available	580/450	7704003767
R5				
R5 all model	01/74 > 07/79	018780	1393/1310	7700548173
R5 all model	07/79 >	Not available	1660/1600	7704003283-7704348431 7704003829
R19				
R19 & CHAMADE TS GTS TSE	07/89 > 04/97	082850	1890/1810	7700793639
SUPER 5				
SUPER 5	09/84 > 12/96	064230	1750	7700766035

SEAT				
IBIZA				
IBIZA I	04/83 > 05/93	Not available	1400/1290	X039519800
IBIZA II	05/93 > 03/02	Not available	1130/1040	X039644910

TALBOT				
SAMBA				
SAMBA all model	82 > 86	Not available	1186/1100	9750540980

**Pour toutes questions notre service technique est disponible
du lundi au vendredi de 8H00 à 12H15 et de 13H15 à 17H00
Tél. 04 74 46 07 36**

Véhicule Vehicle	Année Year	SEIM P/n	Longueur Lenght	OE
---------------------	---------------	-------------	--------------------	----

CITROËN
AX

AX all model sauf/ SPORT	09/86 -> OPR 05284 (05/91)	Not available	1330/1220	96019705
AX all model sauf SPORT	OPR 05285 (06/91)> 06/98	063641	1570/1500	95613456
AX SPORT	09/86 -> OPR 05284 (05/91)	Not available		95638605
AX SPORT	OPR 05285 (06/91)> 06/98	Not available		96085078

FIAT
PANDA

PANDA all model	80 -> 92	114113	1380/1150	4406531-4467961-7609324
PANDA all model	92 -> 08/03	Not available	1105/1026	7699920

PEUGEOT
205

205 all model sauf/except automatic	03/83 -> 07/87	061990	930/850	166011-166013
205 all model sauf/except automatic	07/87 -> 12/98	Not available	1298/1445	166071

RENAULT
CLIO

CLIO all model	06/90 -> 02/98	064232	1710/1620	7700803223
----------------	----------------	--------	-----------	------------

R4

R4 all model	79 -> 12/92	Not available	580/450	7704003767
--------------	-------------	---------------	---------	------------

R5

R5 all model	01/74 -> 07/79	018780	1393/1310	7700548173
R5 all model	07/79 ->	Not available	1660/1600	7704003283-7704348431 7704003829

R19

R19 & CHAMADE TS GTS TSE	07/89 -> 04/97	082850	1890/1810	7700793639
--------------------------	----------------	--------	-----------	------------

SUPER 5

SUPER 5	09/84 -> 12/96	064230	1750	7700766035
---------	----------------	--------	------	------------

SEAT
IBIZA

IBIZA I	04/83 -> 05/93	Not available	1400/1290	X039519800
IBIZA II	05/93 -> 03/02	Not available	1130/1040	X039644910

TALBOT
SAMBA

SAMBA all model	82 -> 86	Not available	1186/1100	9750540980
-----------------	----------	---------------	-----------	------------

2014-2015

Tirettes universelles



Universal shoke

Starter universalali

Estrangulador universales

Universaldrossel



Réf. tirettes tout usage	Longueur de gaine	Longueur totale	Nature du fil	Gaine	Ø du fil	Course mm	Ø de perçage	Spécificités	Boutons
Tirettes standards									
250821	1500	1650	FIL RIGIDE	GALVA NON GUIPEE	1,3	40	10,2	CABLE INOX	A
250824	1200	1350	FIL RIGIDE	GALVA NON GUIPEE	1,3	40	10,2	CABLE INOX	A
250825	1800	1950	FIL RIGIDE	GALVA NON GUIPEE	1,3	40	10,2	CABLE INOX	A
250829	2000	2150	FIL RIGIDE	GALVA NON GUIPEE	1,3	40	10,2	CABLE INOX	A
250830	2500	2650	FIL RIGIDE	GALVA NON GUIPEE	1,3	40	10,2	CABLE INOX	A
250831	3000	3150	FIL RIGIDE	GALVA NON GUIPEE	1,3	40	10,2	CABLE INOX	A
250832	3500	3650	FIL RIGIDE	GALVA NON GUIPEE	1,3	40	10,2	CABLE INOX	A
250834	4500	4650	FIL RIGIDE	GALVA NON GUIPEE	1,3	40	10,2	CABLE INOX	A
251807	1500	1650	CABLE SOUPLE	GALVA NON GUIPEE	1,5	40	10,2	CABLE INOX	A
251809	2000	2150	CABLE SOUPLE	GALVA NON GUIPEE	1,5	40	10,2	CABLE INOX	A
251810	2500	2650	CABLE SOUPLE	GALVA NON GUIPEE	1,5	40	10,2	CABLE INOX	A
251812	3500	3650	CABLE SOUPLE	GALVA NON GUIPEE	1,5	40	10,2	CABLE INOX	A
251813	4000	4150	CABLE SOUPLE	GALVA NON GUIPEE	1,5	40	10,2	CABLE INOX	A
418908	1800	1950	FIL RIGIDE	GALVA GUIPEE	1,5	50	10,2		F
412920	1500	1700	FIL RIGIDE	GALVA NON GUIPEE	1,5	80	10,2		F
412937	3500	3595	FIL RIGIDE	GALVA GUIPEE	1,3	80	10,2		F
481911	3050	3180	FIL RIGIDE	GALVA GUIPEE	1	55	10,2		D
481917	2810	3410	FIL RIGIDE	GALVA GUIPEE	1,5	55	10,2		D

Poignées simples micrométrique	Longueur de gaine	Longueur totale	Nature du fil	Gaine	Ø du fil	Course mm	Ø de perçage	Spécificités	Boutons
Tirettes spécialisées									
908904	1800	2000	FIL RIGIDE	GALVA GUIPEE	1,5	60	16,2		H
115390	3500	3620	FIL RIGIDE		1,5	100	10,2	POIGNEE ROUGE MARQUAGE STOP	K
115391	3500	3620	FIL RIGIDE		2	100	10,2	POIGNEE ROUGE MARQUAGE STOP	K
115410	2000	2150	CABLE SOUPLE		1,5	75	10,2	CABLE MONO GALVA 1.5 BOUTON NOIR NEUTRE	D
115413	2000	2150	FIL RIGIDE		1,9	100	10,2	FIL INOX 1.9 BOUTON NOIR	J
115414	3500	3650	FIL RIGIDE		1,9	100	10,2	FIL INOX 1.9 BOUTON NOIR	J

Tirettes de ralentissement et d'arrêt moteur	Longueur de gaine	Longueur totale	Nature du fil	Gaine	Ø du fil	Course mm	Ø de perçage	Spécificités	Boutons
Tirettes spécialisées									
063570	2850	2600	CABLE SOUPLE	GALVA GUIPEE	1,5				C
115415	2000	2150	FIL RIGIDE		1,9	100	14,2	FIL INOX 1.9 POIGNEE PLASTIQUE AUTOBLOQUANTE	I
115416	3500	3650	FIL RIGIDE		1,9	100	14,2	FIL INOX 1.9 POIGNEE PLASTIQUE AUTOBLOQUANTE	I

Cables au modèle

Nous réalisons à votre demande des câbles hors série.

N'hésitez pas à nous consulter au moyen d'un plan ou d'un modèle

Devis au modèle forfaitaire de 15€ sous une semaine, réalisation sous 15 jours environ.

Devis sur plan forfaitaire de 7.50€ sous une semaine, réalisation sous 15 jours environ.

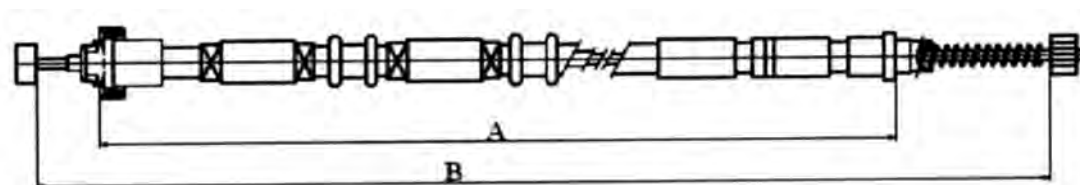

Embouts de tirettes



2014-2015

Table de correspondance

Cross reference table

Tabella di corrispondenza

*Tabla de
correspondencias*

Korrespondenz-tabelle



BENDIX	SEIM	BENDIX	SEIM	BENDIX	SEIM	BENDIX	SEIM
411011B	062670	421098B	200250	422700B	200431	422788B	200751
411022B	084140	421099B	200330	422702B	101781	422789B	200761
411025B	084310	421101B	200640	422703B	401270	422790B	554595
411059B	084011	421102B	401180	422704B	401490	422792B	401090
411064B	062041	421103B	200320	422705B	200440	422793B	401430
411065B	084130	421104B	200280	422706B	401450	422794B	401330
411066B	082310	421105B	401390	422708B	401500	422803B	101190
411070B	081720	421106B	401170	422711B	401510	422804B	101300
411081B	056870	421107B	401300	422712B	401630	422805B	101220
411100B	084090	421108B	200340	422713B	401350	422806B	101230
411101B	084093	421109B	200350	422716B	600600	422807B	101250
411102B	084091	421114B	701000	422720B	600620	422808B	101260
412511B	084530	421115B	650260	422721B	600540	422809B	200380
412552B	084053	421116B	650431	422722B	600670	422810B	101830
412592B	084330	421117B	550070	422723B	200361	422811B	310203
421003B	554856	421118B	600510	422724B	550542	422812B	101791
421009B	200000	421119B	600490	422725B	101160	422813B	200180
421013B	200010	421120B	550420	422726B	101280	422815B	200450
421014B	400920	421121B	550260	422730B	650350	422816B	101151
421015B	200100	421122B	701200	422733B	650400	422819B	200570
421016B	400020	421137B	100970	422734B	650420	422820B	310200
421020B	200160	421142B	100990	422735B	650430	422821B	101730
421024B	400110	421144B	200300	422737B	200770	422822B	101843
421026B	400130	421156B	550320	422738B	200610	422823B	200701
421027B	100900	421173B	600570	422739B	101331	422825B	401520
421028B	100010	421174B	701050	422740B	101311	422828B	401690
421032B	100950	422011B	701090	422741B	101321	422829B	600480
421033B	100940	422013B	701100	422742B	200780	422830B	600560
421034B	400990	422014B	701080	422743B	200790	422833B	600635
421035B	400980	422017B	701150	422744B	200720	422834B	650443
421038B	100420	422032B	721156	422745B	200741	422835B	550430
421040B	200140	422039B	550440	422746B	200621	422836B	701201
421043B	400120	422080B	650210	422747B	101802	422838B	101130
421046B	200170	422083B	650280	422750B	701190	422842B	701250
421049B	200120	422086B	650370	422751B	701296	422844B	554579
421052B	401260	422089B	401580	422753B	401060	422850B	554565
421054B	401290	422090B	401340	422754B	401540	422853B	101844
421066B	550470	422091B	401220	422755B	600300	422856B	200551
421069B	101030	422127B	600310	422757B	550561	422857B	200651
421072B	200260	422129B	600280	422758B	550562	422859B	200731
421074B	401120	422140B	600400	422762B	721165	422861B	101351
421075B	401100	422405B	200520	422763B	721155	424236B	735200
421076B	550541	422406B	200510	422765B	550563	424239B	710100
421078B	200270	422408B	101341	422767B	401550	424241B	710206
421079B	101080	422415B	401610	422768B	401661	424242B	731204
421080B	401110	422418B	401701	422769B	401621	424247B	731201
421081B	550450	422618B	600500	422770B	401700	431009B	403020
421083B	401190	422629B	550581	422771B	401702	431010B	403030
421084B	200210	422634B	101100	422772B	401600	431014B	103000
421086B	101050	422638B	701130	422774B	701283	431021B	403040
421087B	101000	422639B	701140	422775B	550550	431035B	403100
421088B	200230	422640B	701290	422776B	401671	431036B	403110
421089B	200220	422643B	600580	422777B	701210	431038B	402100
421090B	200200	422646B	200310	422781B	101240	431039B	403960
421091B	200150	422647B	200360	422782B	101090	431041B	403970
421092B	401130	422650B	401530	422783B	101210	431046B	403200
421093B	401140	422653B	721151	422784B	200370	431052B	403940
421094B	400850	422655B	550553	422785B	200560	431053B	403950
421097B	401030	422661B	101110	422786B	200580	431056B	203000

BENDIX	SEIM	BENDIX	SEIM	BENDIX	SEIM	BENDIX	SEIM
431057B	203640	431213B	203780	432116B	653260	432693B	723310
431058B	203420	431214B	203750	432121B	653160	432694B	723320
431059B	203650	431216B	404270	432122B	653170	432704B	553220
431062B	404260	431217B	404010	432123B	653261	432706B	723330
431064B	403930	431218B	404020	432131B	555021	432707B	723361
431065B	203310	431219B	404130	432132B	555020	432725B	404840
431069B	403710	431220B	404120	432145B	404490	432726B	204020
431070B	403700	431221B	404150	432157B	404550	432727B	204010
431073B	403210	431222B	404510	432158B	404560	432728B	204040
431089B	203450	431223B	550240	432159B	404600	432729B	553081
431090B	203460	431224B	553020	432160B	404610	432730B	202440
431092B	103260	431227B	603020	432161B	404650	432731B	603242
431093B	203480	431234B	404160	432162B	404200	432800B	702240
431094B	203730	431235B	404620	432163B	404210	432801B	733212
431095B	404040	431236B	202350	432164B	404470	432802B	102440
431096B	404050	431237B	404240	432166B	402430	432804B	102430
431097B	402930	431238B	404180	432167B	404140	432805B	402970
431100B	203690	431239B	404480	432169B	404350	432806B	402440
431103B	103560	431240B	203940	432170B	404360	432807B	402960
431104B	403630	431241B	203950	432174B	603294	432808B	404977
431105B	403990	431242B	203880	432175B	603270	432809B	404881
431106B	403620	431243B	203840	432176B	603050	432810B	404976
431107B	404000	431244B	203850	432402B	404080	432811B	404910
431110B	303160	431245B	203860	432404B	554422	432812B	553225
431111B	203010	431246B	203870	432405B	404110	432813B	554518
431112B	203680	431247B	703090	432406B	404640	432814B	703240
431116B	404430	431248B	703011	432408B	203980	432815B	404730
431117B	404440	431249B	703020	432410B	103730	432816B	404850
431122B	403140	431250B	653090	432411B	103950	432818B	404580
431124B	703000	431254B	650250	432413B	103740	432820B	404710
431125B	703060	431255B	102420	432414B	103790	432822B	404720
431127B	404980	431266B	404250	432416B	202361	432823B	404920
431128B	203660	431271B	404630	432417B	204200	432824B	404975
431129B	203670	431288B	103630	432418B	204210	432825B	553210
431130B	203930	431289B	103690	432420B	103800	432826B	723360
431131B	102400	431290B	103700	432421B	103810	432827B	723311
431132B	703010	431291B	103720	432422B	404320	432828B	204250
431134B	550040	431293B	203740	432427B	203990	432829B	204240
431164B	600050	431300B	603070	432627B	703491	432832B	103840
431172B	550120	431362B	703170	432629B	554857	432833B	103780
431175B	550140	431363B	703160	432639B	103680	432836B	554030
431179B	550250	432012B	805007	432640B	103660	432840B	553160
431180B	550290	432016B	703220	432641B	103650	432841B	554502
431183B	352310	432019B	703100	432644B	803190	432842B	553030
431189B	650240	432020B	703110	432645B	703190	432847B	404330
431190B	653080	432027B	202390	432648B	703494	432848B	404340
431196B	553050	432028B	204160	432649B	554028	432850B	404460
431197B	553060	432029B	204170	432652B	703350	432851B	404940
431201B	404090	432032B	763030	432657B	103770	432852B	404941
431202B	404100	432041B	553000	432662B	603160	432853B	404800
431203B	203320	432044B	723000	432664B	603090	432854B	404810
431204B	203800	432046B	553010	432667B	603266	432855B	404820
431205B	203830	432047B	553040	432678B	653040	432856B	404830
431206B	203810	432048B	553140	432680B	203910	432857B	404760
431207B	203820	432062B	553090	432681B	203920	432858B	404770
431208B	103550	432064B	554018	432684B	103760	432859B	404978
431209B	203790	432104B	653030	432685B	103750	432860B	404979
431210B	103610	432113B	653190	432686B	404530	432863B	204270
431212B	203770	432114B	653180	432687B	404540	432864B	204180

BENDIX	SEIM
432865B	104010
432866B	104020
432867B	204291
432868B	204292
432869B	103890
432870B	103900
432871B	104030
432872B	104040
432873B	103930
432874B	103940
432875B	103910
432876B	103920
432877B	204190
432878B	103710
432880B	204070
432881B	204080
432882B	204060
432884B	204050
432885B	203970
432886B	203960
432887B	203890
432888B	203900
432893B	703500
432894B	703501
432895B	554549
432898B	104050
432899B	204260
432900B	204280
432901B	204281
432907B	352308
432909B	652140
432910B	653291
432911B	653270
432912B	653292
432913B	653288
432916B	103850
432917B	103860
432921B	404500
432922B	404570
432924B	353004
432925B	353003
432930B	554122
432931B	603252
432933B	603251
432934B	603263
432935B	653285
432936B	653240
432937B	554365
432938B	553180
432939B	553211
432943B	723362
432951B	103600
432952B	103830
432954B	103870
432955B	103880
432956B	103970
432957B	103980
432958B	104041
432962B	202374

BENDIX	SEIM
432963B	204293
432965B	402920
432970B	402480
432971B	404670
432972B	404780
432973B	404790
432974B	404880
432975B	723363
432978B	603230
432980B	603210
432984B	653298
432986B	553222
432992B	703430
432995B	703470
432996B	703480
433004B	404740
433005B	404750
433006B	404890
433007B	554371
433009B	404972
433010B	404974
433011B	703120
433014B	653241
433016B	653242
433017B	554392
433021B	554292
433030B	104100
433038B	554864
433041B	554045
433042B	104060
433045B	204295
433067B	603293
433071B	713301
433083B	554265
433084B	554266
433103B	554123
433112B	653284
433119B	204297
433127B	404652
433128B	404651
433129B	404653
433130B	404654
433135B	554074
433136B	554075
433141B	204303
433158B	554391
433173B	103990
433176B	603297
433179B	653309
433180B	653308
434362B	710300
434363B	713040
434365B	713050
434370B	713337
434371B	713336
434372B	713338
434373B	713339
434381B	733340
434382B	733315

BENDIX	SEIM
434396B	733208
434397B	733309
434398B	733310
434422B	733311
434433B	554144
434434B	554145
434459B	554344
434460B	554345
434477B	554938
434486B	404690
440001B	500952
440002B	500902
440003B	501801
440004B	500601
440006B	500971
440007B	500953
440008B	500561
440011B	500450
440012B	501411
440015B	500620
440016B	501670
440017B	500582
440018B	501520
440019B	501552

CABOR	SEIM
11296	401060
19302	720030
110297	084330
10.0004	081522
10.0151	600320
10.0152	600330
10.021	011186
10.022	015790
10.0231	084210
10.032	054461
10.0321	062045
10.0332	084205
10.0371	084070
10.0381	062670
10.0390	122185
10.0862	122107
10.100	550190
10.1041	554614
10.1042	554615
10.1171	084310
10.1177	084390
10.1184	084140
10.209	550520
10.213	100010
10.216	100500
10.218	100420
10.2372	401350
10.241	600510
10.2411	600400
10.2412	600540
10.244	600520
10.2441	600280

CABOR	SEIM
10.2443	600600
10.2444	600620
10.2451	554793
10.269	200100
10.270	200000
10.271	554856
10.272	400020
10.274	400110
10.279	400420
10.284	400120
10.2842	401300
10.2843	401550
10.2844	401690
10.2890	401712
10.292	400980
10.293	400990
10.295	401010
10.2961	401490
10.2963	401450
10.2964	401670
10.2966	401700
10.2967	401671
10.2968	401701
10.2969	401621
10.297	400930
10.2971	401500
10.2973	401510
10.298	400850
10.2982	401100
10.2983	401120
10.2984	401180
10.2985	401160
10.2986	401190
10.2987	401170
10.306	550260
10.3139	554612
10.314	550150
10.3143	550460
10.315	550070
10.3151	554604
10.3153	550490
10.3154	721163
10.3155	721154
10.3159	721165
10.3211	550550
10.3291	554613
10.338	550420
10.339	550230
10.340	550340
10.3411	550541
10.3412	550430
10.3413	550440
10.343	550470
10.3441	721155
10.3443	550542
10.3445	554605
10.3446	550561
10.3447	721153
10.408	554516

CABOR	SEIM	CABOR	SEIM	CABOR	SEIM	CABOR	SEIM
10.4131	554028	10.4662	554075	10.5173	554998	10.611	203310
10.4132	554029	10.4663	554047	10.5174	554997	10.617	203420
10.4134	554030	10.4664	554048	10.5235	554410	10.6201	204020
10.4135	554031	10.4665	554906	10.5236	554412	10.6202	204010
10.4138	554027	10.4666	554907	10.5237	554411	10.6203	204040
10.4155	554039	10.4668	554653	10.530	603010	10.6211	202361
10.4156	554041	10.467	103520	10.532	603000	10.6212	204200
10.4157	554034	10.468	103560	10.533	603130	10.6213	204210
10.4158	554033	10.4681	103680	10.5338	554948	10.6215	204190
10.4231	554864	10.4682	103660	10.5342	554949	10.6216	204281
10.4232	554032	10.4683	103650	10.5343	554950	10.6217	204280
10.4265	554038	10.470	103630	10.5344	554951	10.6218	202374
10.4266	554037	10.4701	103970	10.5345	554952	10.6220	204270
10.4267	554036	10.4702	103980	10.5351	603030	10.6221	204180
10.4268	554035	10.4705	103800	10.5357	603220	10.6223	202373
10.4300	554331	10.4706	103810	10.5359	603210	10.6224	204300
10.4301	554330	10.4707	104041	10.536	603020	10.6230	204301
10.4302	554333	10.4708	554042	10.5360	554112	10.6232	554677
10.4303	554332	10.4709	554043	10.5362	603231	10.6233	554676
10.4306	554337	10.471	103610	10.5363	554113	10.6235	554673
10.4307	554336	10.4710	554044	10.5365	603298	10.633	203480
10.450	103000	10.4712	103780	10.5366	554115	10.634	203730
10.4510	204304	10.4713	103840	10.5367	554114	10.635	203640
10.4511	204303	10.4714	104060	10.5368	554110	10.636	203650
10.4520	554045	10.4715	104070	10.5369	554109	10.638	203460
10.4521	554046	10.4716	104100	10.5370	554111	10.639	203450
10.4524	554758	10.4717	104110	10.5371	554117	10.644	203690
10.4525	554759	10.4720	102430	10.5373	554118	10.6441	203930
10.4526	554760	10.4721	104080	10.5374	554119	10.645	203670
10.4561	103850	10.4722	104090	10.5379	554938	10.646	203680
10.4562	103860	10.4723	202470	10.5416	602000	10.648	203740
10.4563	103870	10.4724	204295	10.5451	554128	10.650	403040
10.4564	103880	10.4725	204296	10.557	600070	10.652	403020
10.4565	103900	10.4726	554057	10.558	600050	10.653	403030
10.4566	103890	10.4728	554058	10.560	763010	10.654	402100
10.4571	103710	10.4731	554056	10.562	763030	10.6542	404320
10.4572	103720	10.4732	204294	10.564	763040	10.6543	404850
10.4573	103690	10.4733	554051	10.601	203010	10.6544	554408
10.4574	103700	10.4735	554050	10.6011	203880	10.6545	554407
10.4575	103910	10.4736	554049	10.602	203660	10.655	403100
10.4576	103920	10.4738	554052	10.6021	203840	10.656	403110
10.4577	103930	10.4739	554065	10.6022	203850	10.660	403200
10.4578	103940	10.4740	554059	10.6023	203910	10.661	403210
10.458	103260	10.4741	554060	10.6024	203920	10.667	404260
10.4581	104030	10.4742	554061	10.6025	203890	10.6681	404950
10.4582	104040	10.4743	554063	10.6026	203900	10.6682	404710
10.460	103060	10.4744	554062	10.6027	103760	10.6683	404920
10.4611	104050	10.4745	554064	10.6028	103750	10.6684	404930
10.4612	554901	10.5154	554996	10.6031	204292	10.6685	404931
10.464	103570	10.5159	555000	10.6032	204291	10.6686	404972
10.465	103550	10.5160	554215	10.6033	204240	10.6687	404974
10.4651	103740	10.5161	554214	10.6034	204250	10.6688	404973
10.4652	103730	10.5162	554217	10.6035	204297	10.6691	404570
10.4653	103790	10.5163	554216	10.6036	204298	10.6692	404840
10.4654	104010	10.5166	554644	10.6043	204260	10.6693	404670
10.4655	104020	10.5167	555004	10.6044	204293	10.6694	404580
10.4656	103950	10.5170	555001	10.6045	554395	10.6696	404680
10.466	103050	10.5171	555002	10.6046	554761	10.6697	404690
10.4661	554074	10.5172	554999	10.610	203320	10.6698	404941

CABOR	SEIM	CABOR	SEIM	CABOR	SEIM	CABOR	SEIM
10.6699	404940	10.7433	554492	10.8068	554547	10.9512	554275
10.676	403700	10.744	550250	10.8172	554548	10.9513	554276
10.6761	404330	10.745	550290	10.8182	554549	10.9514	554273
10.6762	404340	10.747	553020	10.8184	554550	10.9515	554277
10.6763	404350	10.7471	553030	10.8185	554546	10.9584	554280
10.6764	404360	10.748	553050	10.8186	554541	10.9586	554285
10.677	403630	10.7481	554512	10.8187	554553	10.9587	554286
10.6771	404130	10.7482	554513	10.8188	554551	10.9588	554283
10.6772	404120	10.7483	554514	10.8189	554552	10.9589	554284
10.6773	404180	10.7484	554515	10.8221	554532	10.9593	555029
10.6774	404530	10.7491	553171	10.8222	554533	10.9831	554291
10.6775	404540	10.7492	553060	10.8223	554534	10.9832	554292
10.6776	404720	10.7493	553220	10.8224	554535	10.9833	554319
10.6777	404730	10.750	550270	10.8225	554537	10.9834	554326
10.678	403620	10.7502	550280	10.8226	554536	10.9835	554320
10.679	403710	10.7503	553095	10.8227	554529	10.9836	554322
10.6791	404910	10.7504	553081	10.8581	554415	10.9837	554321
10.6792	554404	10.7505	723362	10.8582	554416	10.9863	554307
10.6793	554405	10.7507	554008	10.8594	554413	10.9864	554308
10.6794	554762	10.7509	553084	10.8595	554414	10.9865	554309
10.6852	404977	10.7512	554009	10.9033	553224	10.9866	554310
10.6853	404975	10.7513	554010	10.9038	554646	10.9867	554311
10.6854	404976	10.7514	554011	10.9040	554425	10.9868	554312
10.6890	404988	10.7515	554007	10.9041	554426	10.9873	554296
10.6891	554647	10.7516	554012	10.9042	554427	10.9874	554297
10.6892	554091	10.7517	723366	10.9043	555116	10.9875	554303
10.6893	554092	10.7518	554417	10.9325	554257	10.9876	554304
10.6895	554909	10.7531	553085	10.9326	554256	10.9877	554298
10.691	303160	10.7533	554016	10.9327	554258	10.9878	554299
10.713	550040	10.7534	554013	10.9328	554255	10.9879	554305
10.7131	553120	10.7535	554017	10.9329	554254	10.9880	554306
10.7132	554517	10.7536	554015	10.9330	554253	10.9881	554293
10.7133	553211	10.7537	554014	10.9331	554316	10.9882	554294
10.7134	553200	10.7543	553070	10.9332	554259	10.9883	554300
10.7135	553210	10.7544	553080	10.9333	554260	10.9884	554295
10.7136	723360	10.7546	554025	10.9334	554261	10.9885	554302
10.7137	723361	10.7560	554026	10.9336	554428	10.9886	554301
10.7138	554418	10.7562	554024	10.9337	554429	10.9890	554313
10.7139	554419	10.7563	554862	10.942	555021	10.9891	554314
10.7140	554420	10.7564	554863	10.943	352310	10.9892	554315
10.7141	554421	10.7583	554018	10.9434	554265	10.9895	555031
10.7384	555139	10.7585	554022	10.9435	554266	10028.2	505040
10.739	553100	10.7586	554021	10.9436	554264	10030.2	500910
10.7391	553221	10.7587	554020	10.9439	554263	10034.2	500810
10.7392	554518	10.7588	554019	10.9444	554271	10035.2	501811
10.7393	553225	10.7589	554023	10.9445	554270	10037.2	501810
10.7394	554519	10.7620	553180	10.9447	554272	10049.2	501670
10.7395	554520	10.7621	652151	10.9450	555022	10062.2	505020
10.7396	554521	10.7626	554524	10.9453	554289	10066.2	505030
10.7397	554522	10.7627	554525	10.9454	554290	10067.2	505210
10.7398	554523	10.7628	554526	10.9455	554281	10068.2	505220
10.740	550240	10.7630	554528	10.9456	554282	10072.2	501410
10.7401	553000	10.7631	554527	10.9457	554278	10074.2	501551
10.7402	553010	10.8061	554542	10.9458	554279	10078.2	501650
10.7403	553040	10.8063	554543	10.9462	554267	10079.2	501540
10.7405	554502	10.8064	554530	10.9463	554269	10080.2	500952
10.7406	553160	10.8065	554540	10.9464	554268	10082.2	501401
10.7409	553140	10.8066	554545	10.9465	555026	10083.2	501411
10.741	550160	10.8067	554539	10.9511	554274	10084.2	501100

CABOR	SEIM	CABOR	SEIM	CABOR	SEIM	CABOR	SEIM
10088.2	501520	11.224	100970	11.279	401570	11.315	550450
10089.2	501150	11.2241	101050	11.287	401130	11.316	550210
10180.2	501220	11.2242	101100	11.2871	401140	11.3214	200770
10181.2	501840	11.2243	101110	11.290	401520	11.3215	200791
10182.2	501300	11.2244	101280	11.291	401090	11.3235	200361
10183.2	502440	11.2245	101290	11.2911	554598	11.3239	554595
10187.2	501801	11.2248	101311	11.2912	401430	11.3264	200440
10188.2	500953	11.2251	101160	11.2913	401710	11.3265	200431
11.0123	600340	11.2252	101170	11.2914	554597	11.3266	200780
11.0161	554629	11.2255	101844	11.2915	401540	11.3267	200790
11.0176	122108	11.2256	101845	11.292	401290	11.3268	200721
11.0177	122105	11.226	101030	11.293	401000	11.3921	200510
11.021	081720	11.2280	101321	11.2962	401260	11.3922	101341
11.0221	084093	11.2281	101351	11.2963	401270	11.3923	200520
11.0271	084490	11.2282	101151	11.2971	401600	11.3924	101781
11.0273	084520	11.2283	101331	11.300	200170	11.3925	554565
11.0281	084090	11.2284	101802	11.3001	200270	11.5346	554946
11.0282	084091	11.2295	554562	11.3002	200290	11.544	603040
11.0284	084053	11.232	600160	11.3004	200230	11.5441	603050
11.029	084340	11.2321	600490	11.3005	200640	11.5442	603150
11.043	062060	11.2322	600500	11.3006	200250	11.5443	603170
11.065	550410	11.2323	600550	11.3007	200280	11.5444	603160
11.082	550380	11.2324	600670	11.3008	200300	11.5445	603200
11.087	550100	11.2327	600633	11.3011	200340	11.5446	554122
11.1246	554639	11.2328	600634	11.3012	200350	11.5448	554123
11.150	084350	11.2329	600635	11.3013	200480	11.545	600210
11.192	061783	11.2363	600300	11.3014	200600	11.5451	603294
11.1942	500550	11.243	600560	11.3015	200610	11.5452	602240
11.1962	084011	11.2432	600310	11.3016	200380	11.5454	603230
11.1963	122098	11.2433	600570	11.302	200120	11.5455	554124
11.198	084130	11.2435	600580	11.3028	554664	11.5459	554125
11.201	550350	11.246	600640	11.3029	200651	11.5462	554936
11.2141	101130	11.2462	600590	11.303	200180	11.548	600180
11.2142	101240	11.247	600480	11.3031	200330	11.549	600290
11.2143	101210	11.248	600270	11.3033	200310	11.5494	554120
11.2144	101300	11.250	650100	11.3034	200320	11.5495	554121
11.2145	101230	11.253	650210	11.3035	200360	11.5502	603090
11.2146	101220	11.2531	650370	11.3038	200630	11.5503	603100
11.2147	101250	11.2532	650400	11.304	200260	11.5505	603120
11.2148	101310	11.2533	650430	11.3041	200740	11.5507	603262
11.2149	101150	11.2534	650440	11.3042	200750	11.5510	603266
11.2151	101330	11.2535	650441	11.3043	200760	11.5511	603297
11.2152	101260	11.2536	554586	11.3045	200701	11.5513	554130
11.2153	101840	11.2537	554587	11.3046	200710	11.5571	554134
11.2154	101830	11.255	650260	11.3047	200370	11.5573	603285
11.216	100980	11.2551	650443	11.3048	200741	11.5576	603288
11.217	101000	11.2552	650280	11.3049	200751	11.5577	603287
11.218	100930	11.256	650431	11.305	200140	11.5578	554135
11.219	100990	11.2561	650350	11.3058	200551	11.566	603070
11.2191	101090	11.2562	650420	11.3059	200731	11.5661	603281
11.2195	101140	11.269	200130	11.306	200220	11.5662	603282
11.2196	101350	11.270	200010	11.3060	554668	11.5664	554139
11.2198	101791	11.271	200160	11.3062	200420	11.5665	554137
11.2199	554564	11.272	400920	11.3064	200441	11.5666	603292
11.220	100940	11.273	400130	11.3066	200500	11.5667	603291
11.221	100950	11.2781	401560	11.3067	200490	11.5668	554138
11.2211	101190	11.2782	401330	11.3068	200720	11.5669	554136
11.222	100960	11.2783	401340	11.307	200200	11.567	603080
11.2221	101080	11.2784	401030	11.308	200210	11.568	554133

CABOR	SEIM	CABOR	SEIM	CABOR	SEIM	CABOR	SEIM
11.5741	653282	11.5946	554389	11.6682	554400	11119.2	500901
11.5743	653284	11.5950	554367	11.6683	554401	11130.2	501813
11.5744	653281	11.5953	653307	11.676	404080	11133.2	501020
11.5745	653303	11.6021	202350	11.6761	404100	11134.2	554766
11.5746	653302	11.6022	203940	11.6762	404090	11135.2	500891
11.5751	653190	11.6023	203950	11.6763	404600	11136.2	500892
11.5752	653180	11.6024	202360	11.6764	404610	11138.2	502350
11.5753	653170	11.6025	203980	11.6765	404640	11139.2	500971
11.5754	653160	11.6026	203990	11.6766	404650	11140P2	500896
11.5755	653200	11.603	203770	11.6767	404620	11170.2	500302
11.5756	554371	11.6031	203860	11.6768	404630	11171.2	500621
11.5757	554374	11.6032	203870	11.677	403990	11175.2	500601
11.5758	554372	11.604	203780	11.6771	404900	11176.2	500390
11.5759	554373	11.605	203790	11.678	404000	11177P2	500561
11.5760	554368	11.606	203830	11.679	404110	11178P2	500462
11.5761	653304	11.607	203800	11.6791	402930	11185.2	500300
11.5762	653305	11.608	203810	11.6792	404200	11186.2	500620
11.5763	554728	11.609	203820	11.6793	404210	11188.2	500970
11.5764	554370	11.612	103500	11.6794	404980	11191.2	500260
11.5765	554369	11.650	403930	11.6795	404460	11192.2	500430
11.5766	554386	11.655	404040	11.6796	404740	11194.2	500582
11.5767	554387	11.656	404050	11.6797	404750	11223.2	505325
11.5768	653308	11.657	403960	11.6798	404978	11224.2	505260
11.5769	653309	11.6571	404653	11.6799	404979	11225.2	505190
11.5770	554375	11.6572	404654	11.6801	653152	11232P2	505300
11.5771	554376	11.6573	404651	11.6802	653299	1162.1	100900
11.5772	554377	11.6574	404652	11.6803	404982	1163.5	084430
11.5773	554379	11.658	403970	11.6805	404984	1171.1	203750
11.5774	554380	11.6581	404240	11.6807	404983	1171.2	102400
11.5775	554381	11.6582	404250	11.6809	554394	1171.3	102420
11.5776	554378	11.6583	404830	11.682	404060	1171.7	202440
11.5791	653241	11.6584	404820	11.6821	404430	1171.8	103770
11.5824	554868	11.6585	404810	11.683	402950	1172.1	200150
11.583	650240	11.6586	404800	11.684	402960	1172.2	200560
11.584	650250	11.6591	404140	11.685	404070	1172.3	200570
11.5853	653230	11.6592	404160	11.6851	404440	1172.4	200580
11.5854	653040	11.6593	404170	11.704	550120	1172.7	101730
11.5855	653100	11.6594	404500	11.9021	600200	1172.8	101843
11.5856	653140	11.6597	404881	11.905	600412	1173.2	084410
11.5857	554365	11.6598	404880	11.916	600190	12.0101	554003
11.5858	554648	11.6599	554399	11.917	600260	12.0102	554002
11.5859	653240	11.660	402920	11.919	554628	12.0103	554005
11.5862	554366	11.6600	554398	11.923	600411	12.0104	554006
11.5863	653287	11.662	404010	11.927	600350	12.0701	703451
11.5864	653242	11.664	404020	11000.2	500230	12.0702	703452
11.5865	554392	11.6642	404510	11001.2	500790	12.0704	703463
11.5866	554391	11.6661	404658	11005.2	500700	12.0705	703462
11.5867	554393	11.6662	404657	11008.2	500761	12.0707	554910
11.590	653030	11.6663	404656	11027.2	505060	12.0708	554098
11.592	653080	11.6664	404655	11028.2	505050	12.0709	554097
11.5931	653090	11.667	403980	11029.2	505331	12.0710	554096
11.5932	652140	11.6671	403140	11031.2	501621	12.0711	554926
11.5933	653270	11.6673	404550	11034.2	500980	12.0713	554106
11.5934	653291	11.6674	404560	11035.2	500942	12.0714	554105
11.5935	653292	11.6675	404760	11036.2	501940	12.0715	703453
11.5936	653298	11.6676	404770	11037.2	501622	12.0720	703503
11.5938	554727	11.6677	404780	11038.2	501942	12.0721	803502
11.5944	653271	11.6678	404790	11043.2	505333	12.0722	554093
11.5945	554388	11.6679	405300	11045.2	505100	12.0728	554923

CABOR	SEIM	CABOR	SEIM	CABOR	SEIM	CABOR	SEIM
12.0729	554922	1252.7	701288	17.0015	710301	17.1071	733302
12.0730	554068	1252.9	701299	17.0123	554731	17.1072	733344
12.0731	554067	1253.1	700200	17.0124	710321	17.1073	733343
12.0732	554070	1253.3	700030	17.0127	554351	17.1074	554483
12.0733	554069	1253.4	700180	17.0221	710302	17.1075	554484
12.0734	554916	1253.8	084671	17.0246	554353	17.1076	554485
12.0735	554917	1261.1	703220	17.0247	554352	17.1077	554486
12.0736	554100	1261.3	703494	17.0324	555078	17.1080	554487
12.0737	554099	1262.1	701201	17.0325	555079	17.1081	554488
12.0738	554918	1262.2	701180	17.0326	555080	17.1082	554489
12.0739	554101	1281P1	803190	17.0327	555081	17.1083	554490
12.0740	554925	1281P2	703190	17.0328	555082	17.1223	554472
12.0741	554924	1281P4	703200	17.0335	554361	17.1227	554473
12.0742	554104	1282P1	701130	17.0336	554362	17.1228	554474
12.0743	554103	1282P2	701140	17.0337	554356	17.1286	554461
12.0744	554108	1283P3	700201	17.0338	554357	17.1287	554462
12.0745	554912	13.101	103310	17.0339	554358	17.1288	554463
12.0746	554911	13.104	106490	17.0340	554359	17.1415	554452
12.0747	554914	13.106	010523	17.0347	554402	17.1416	554453
12.0750	554859	13.153	054140	17.0348	554403	17.1418	554455
12.0751	554858	14.201	600410	17.0349	555083	17.1419	554456
12.0752	554861	14.312	084320	17.0366	555076	17.1423	554454
12.0764	554127	14.317	062041	17.0367	555077	17.1425	554465
12.0765	554126	1401.3	703100	17.0510	555005	17.1426	554469
12.102E	554422	1402.1	701090	17.0582	735316	17.1427	554467
12.1500	554213	1402.2	701100	17.0583	735317	17.1428	554468
12.1501	554207	1402.3	701190	17.0585	554222	17.1436	554470
12.1502	554206	1403.3	700210	17.0586	554221	17.1437	554471
12.1503	554993	15.102E	722010	17.0587	554223	17.1469	554460
12.1504	554992	15.103E	723000	17.0588	554252	17.1480	554457
12.201E	721157	15.1314	356200	17.0589	554251	17.1481	554458
12.202E	721158	15.1316	356203	17.0594	554241	17.1482	554459
12.3702	554744	15.1317	356202	17.0595	554240	17.1483	554645
12.3703	554182	15.206E	721160	17.0596	554239	17.1527	555127
12.3704	554183	15.207E	721030	17.0597	554248	17.1528	555128
12.3705	554184	15.208E	721010	17.0598	554247	17.1549	554560
12.3706	554185	16.600	731000	17.0599	554250	17.1550	733336
12.3707	554186	1601.3	703050	17.0600	554249	17.1551	733335
12.3720	554187	1601.4	703060	17.0601	554246	17.1553	554475
12.3721	554188	1602.10	701284	17.0602	554245	17.1554	554476
12.3722	554745	1602.11	701285	17.0656	554230	17.1556	554477
12.3724	554973	1651.1	703140	17.0657	554229	17.1557	554478
12.3725	554975	1651.10	702240	17.0658	554238	17.1558	554479
12.522	701050	1651.2	703150	17.0659	554237	17.1559	554480
12.7201	554569	1651.20	554094	17.0671	554227	17.1560	554481
12.7202	554571	1651.3	703160	17.0672	554226	17.1561	554482
12.7203	554570	1651.4	703170	17.0676	554225	17.2120	554432
12.7204	554576	1653.10	084661	17.0678	554232	17.2121	554433
12.7205	554578	1653.2	700130	17.0679	554231	17.2123	554431
1201.1	703080	17.0001	713050	17.0681	554224	17.2282	555048
1201.30	703230	17.0002	713040	17.0682	554234	17.2283	555049
1251.1	703010	17.0003	554344	17.0683	554233	17.2290	554054
1251.10	703120	17.0004	554345	17.0684	554220	17.2291	554053
1251.2	703020	17.0005	554346	17.0685	554219	17.2518	554146
1251.5	703011	17.0006	554347	17.0686	554218	17.2519	554147
1251.9	703130	17.0007	554348	17.0687	554236	17.2520	554150
1252.32	701290	17.0008	554349	17.0688	554235	17.2521	554151
1252.33	701291	17.0009	554350	17.0689	554228	17.2522	554152
1252.5	701160	17.0014	710300	17.1070	733303	17.2523	554153

CABOR	SEIM
17.2524	554154
17.2525	554155
17.2526	554156
17.2527	554157
17.2530	554180
17.2531	554181
17.2540	554160
17.2541	554161
17.2542	554162
17.2543	554163
17.2544	554164
17.2545	554165
17.2550	554158
17.2551	554159
17.2552	554170
17.2553	554171
17.2554	554172
17.2555	554173
17.2560	554174
17.2561	554175
17.2562	554176
17.2563	554177
17.2565	554178
17.2566	554179
17.2570	554166
17.2571	554167
17.2575	554168
17.2576	554169
17.2600	554435
17.2601	554434
17.2604	554437
17.2605	554436
17.2720	554383
17.2721	554382
17.2722	554385
17.2723	554384
17.2732	554970
17.2733	554969
17.2734	554972
17.2735	554971
17.3502	554083
17.3503	554084
17.3504	554077
17.3505	554076
17.3506	554088
17.3507	554087
17.3508	554090
17.3509	554089
17.3510	554082
17.3511	554086
17.3512	554085
17.3515	554081
17.3516	554080
17.3530	554079
17.3531	554078
17.4014	731304
17.4015	731305
17.4017	731307
17.4018	731306

CABOR	SEIM
17.4202	554145
17.4203	554144
17.4210	554143
17.4211	554142
17.4220	554555
17.4221	554554
17.5014	554690
17.5016	733509
17.5020	733500
17.5021	733501
17.5022	733502
17.5023	733503
17.5026	554689
17.5028	554444
17.5029	554443
17.5040	554442
17.5041	554441
17.5043	554438
17.5045	554440
17.5046	554439
17.5050	554446
17.5051	554445
17.5062	554448
17.5063	554447
17.5064	554450
17.5065	554449
17.6000	554194
17.6001	554195
17.6020	554199
17.6021	554198
17.6026	554201
17.6027	554200
17.6030	554202
17.6035	554148
17.6036	554149
17.6040	554191
17.6041	554190
17.6042	554193
17.6044	554192
17.6050	554196
17.6051	554197
17.6060	554990
17.6061	554991
1703.4	554630
17600.2	504405
18.0052	710206
18.0071	710100
18.0072	554583
18.214	355005
18.2511	554582
18.2522	554581
18.306	735200
18.3500	734200
18.3501	554561
18.6003	554606
18.601	731201
18.6020	554585
18.6021	554588
18.6022	554584

CABOR	SEIM
18.6101	731203
18.6107	731204
18.6110	554608
18.6111	554609
18.6112	554610
19.101E	723310
19.102E	723320
19.103E	723330
19.105E	723350
19.208E	721151
19.209E	550562
19.211E	550553
19.300E	720010
19.800E	505200
1901.1	703000
1902.2	701000
1902.4	701200
1902.5	701080
1902.6	701283
1903.10	084672
1903.5	700150
1903.8	700220
1905.1	114113
241.2	554857
251.31	703501
251.32	703500
251.33	554001
251.34	554000
3049.2	505070
3089.2	505150
3098.2	505270
3127.2	505290
3133.2	505323
3206.2	501860
321.4	703090
321.5	703240
321.6	703498
321.7	703499
322.5	701294
322.8	701295
412.10	701210
412.11	701220
412.12	554580
413.20	700202
413.21	554621
431.10	554004
431.2	703110
432.3	701110
432.4	701120
441.3	554211
441.4	554210
442.1	701070
442.2	701150
451.1	554209
451.2	554208
461.1	702250
461.10	703360
461.11	703350
461.12	703400

CABOR	SEIM
461.13	703390
461.8	703320
461.9	703310
462.1	701240
462.2	701230
462.4	554573
462.6	701250
463.1	122109
463.3	122132
463.7	122134
463.8	122135
491.1	102440
491.11	703460
491.12	703450
491.13	554102
491.14	703465
491.15	703464
491.2	204080
491.21	703466
491.22	703467
491.3	204070
491.4	204050
491.5	204060
492.1	200511
492.10	554575
492.2	101340
492.3	200521
5F200	320200
5F201	320202
5F202	320201
5R250	320208
5R252	320206
622.11	701293
631.13	554927
631.20	703470
631.21	703480
631.30	554935
631.31	554934
632.12	554577
641.10	703492
641.12	703461
S07101	501120
S07122	500990
S07125	501534
S07126	501530
S21040	500902
S21070	500972
S24017	501023
S24110	501552

LECOY	SEIM
0025	103000
0041	100500
0067	103500
0077	103060
0080	084420
0081	084430
0090	103050

LECOY	SEIM
0093	100420
0094	100980
0115	100010
0117	100940
0120	103570
0121	103560
0123	103600
0130	100930
0134	100970
0140	100900
0144	100950
0146	103550
0153	100990
0162	103630
0165	101000
0173	103610
0184	101060
0185	100960
0186	101080
0200	101030
0201	101050
0222	103680
0223	103650
0224	103660
0229	103830
0230	101090
0236	101190
0237	084140
0238	084400
0240	103720
0241	103710
0245	101160
0246	101170
0251	101130
0254	103740
0255	103730
0257	101100
0258	101110
0259	101210
0261	103760
0269	101720
0270	101300
0273	101220
0275	101230
0278	103790
0279	101280
0280	101290
0281	101240
0282	101250
0283	101260
0284	101270
0285	103780
0286	200380
0300	104000
0301	103800
0302	103810
0306	103950
0308	103840
0309	103870

LECOY	SEIM
0310	103880
0311	103890
0312	103900
0314	102440
0317	103910
0318	103920
0319	103930
0320	103940
0326	101330
0327	103850
0328	103860
0330	103970
0331	103980
0334	103741
0335	104030
0336	104040
0339	102430
0340	104010
0341	104020
0342	084390
0343	101750
0346	101840
0349	104041
0350	104050
0352	104060
0353	104070
0354	104090
0355	104080
0356	104100
0357	104110
0359	101331
0360	554045
0361	554046
0362	101791
362	554564
0364	554042
0365	554043
0366	204304
0367	204303
0372	554074
0373	554075
0376	554044
0378	554053
0379	554054
0380	554616
0381	101844
0382	101845
0393	554758
0394	554759
0395	554760
0400	554056
0401	554058
0403	554050
0404	554051
0405	554057
1002	763040
1004	763030
1007	721180
1306	356308

LECOY	SEIM
1311	356200
1312	356204
1314	356202
1321	356306
1322	356307
1326	653294
1327	554216
1328	554217
1329	554215
1330	554214
1331	554644
2062	203730
2065	203480
2079	059040
2081	200160
2082	103260
2084	203450
2085	203460
2086	203690
2098	200140
2102	103520
2105	203680
2108	102420
2109	203750
2110	200150
2111	084011
2114	200120
2116	203740
2118	102400
2123	203660
2124	203670
2127	200170
2132	061783
2135	200180
2136	203930
2139	203770
2140	203780
2146	200260
2168	203840
2169	203850
2171	203860
2172	203870
2173	200270
2174	203790
2175	203830
2176	203800
2177	203810
2178	203820
2179	200290
2180	200200
2183	200210
2185	200220
2187	200230
2188	200250
2189	200330
2197	200640
2201	084130
2215	200280
2217	200310

LECOY	SEIM
2219	200320
2220	200300
2222	203940
2223	203950
2224	202350
2227	204160
2228	204170
2233	202360
2234	084410
2238	084100
2240	202390
2241	200340
2242	200350
2244	203880
2248	200420
2252	200441
2254	204290
2255	200480
2256	203910
2257	203920
2258	203890
2259	203900
2261	203960
2262	203970
2263	203980
2264	203990
2265	102390
2266	102410
2267	103960
2268	084310
2269	200440
2270	200431
2271	200360
2272	200450
2273	554595
2274	101151
2276	200460
2277	103770
2281	103700
2282	103690
2284	103750
2287	204060
2288	204050
2289	103990
2295	204020
2296	204010
2297	204040
2299	202361
2302	202440
2303	200560
2305	200570
2306	200580
2308	122098
2315	204070
2316	204080
2321	200600
2322	200610
2323	101350
2327	200490

LECOY	SEIM	LECOY	SEIM	LECOY	SEIM	LECOY	SEIM
2328	200500	2405	200910	4238	402950	4423	404160
2329	101340	2406	200650	4243	400930	4424	404170
2330	200521	2413	204297	4245	401570	4440	401170
2331	200511	2414	204298	4246	401580	4442	401180
2332	101140	2415	554664	4253	404040	4444	401330
2333	101150	2416	200911	4271	401010	4446	402930
2334	204200	2418	200651	4272	400920	4447	401600
2335	204210	2419	200551	4273	400990	4448	401270
2336	204190	2421	554062	4278	404010	4451	084320
2342	204240	2422	554064	4279	404020	4452	084330
2343	200721	2423	554060	4291	403970	4453	084340
2345	101730	2424	554063	4292	403960	4457	401300
2347	200720	2425	554061	4294	401000	4458	404240
2349	200790	2429	554655	4295	062150	4466	404250
2350	200780	2430	554052	4301	062060	4479	404640
2351	101843	2431	554065	4303	403700	4480	401710
2354	204291	2432	554069	4304	403710	4483	062673
2355	204292	2433	554070	4305	400850	4495	404550
2356	202371	2434	554049	4309	401260	4496	404560
2357	204250	2434	554067	4319	404430	4497	404500
2359	200700	2435	554068	4321	401290	4498	404480
2360	200710	2436	554761	4323	404270	4499	404650
2361	200740	2439	554677	4324	404980	4504	402480
2362	200750	3077	403020	4325	404460	4505	402970
2363	200760	3078	403030	4326	402960	4507	401430
2364	200520	3093	403040	4328	400980	4508	401130
2365	101341	3112	403100	4333	403980	4512	084091
2366	101780	3113	403110	4334	404080	4513	084093
2367	204270	3116	402100	4335	404110	4514	084053
2368	204280	3119	403210	4337	401520	4537	084280
2369	204281	3120	403200	4348	403140	4541	404330
2370	202373	3139	200000	4352	404120	4542	404340
2371	202374	3141	203640	4353	404130	4543	404350
2374	084580	3142	203420	4354	401100	4544	404360
2375	204180	3143	203310	4358	401120	4546	402440
2380	204260	3144	203650	4360	401390	4555	404530
2381	204294	3145	203320	4363	404150	4556	404540
2382	204296	3152	200010	4364	404140	4567	401140
2383	204295	3153	200100	4365	404200	4582	401490
2384	200522	4031	015790	4367	404210	4583	401610
2385	200770	4078	400020	4368	404470	4584	401450
2386	200791	4098	400420	4371	081720	4599	404570
2387	204293	4123	400130	4372	082310	4600	404580
2388	202470	4142	403620	4373	401560	4601	404730
2389	204301	4143	403630	4374	404090	4608	404840
2390	204302	4153	401060	4375	404100	4609	404670
2391	204300	4171	403990	4376	401090	4610	401500
2392	200361	4172	404000	4389	404510	4611	402971
2393	200741	4173	400120	4390	401110	4612	402972
2394	200751	4180	403940	4393	401190	4614	404680
2395	200761	4181	403950	4403	084070	4617	404690
2396	200701	4188	056880	4409	404600	4627	122149
2398	200711	4191	403930	4410	404610	4634	401550
2399	554562	4211	404260	4411	404620	4638	401510
2400	101311	4215	402920	4412	404630	4639	404720
2401	200510	4217	404050	4414	401220	4645	084520
2402	101351	4218	401030	4415	401340	4647	404760
2403	101781	4225	056870	4418	404180	4648	404770
2404	200550	4234	404440	4419	404490	4649	404780

LECOY	SEIM
4650	404790
4652	404977
4653	404975
4661	122123
4670	084490
4671	084510
4676	404978
4677	404979
4678	401630
4680	401350
4686	404800
4687	404810
4688	404820
4689	404830
4690	404320
4691	404850
4695	084540
4696	084530
4697	401701
4699	401621
4700	401620
4701	404920
4702	404940
4703	404710
4704	404930
4705	404931
4706	404860
4707	404861
4712	401650
4713	401660
4714	401670
4722	122153
4728	404910
4732	404941
4733	404950
4737	404870
4738	404871
4739	404880
4740	404881
4741	404976
4742	401690
4746	404984
4747	404983
4748	404982
4754	404972
4757	404973
4758	404974
4762	404659
4763	404656
4764	404655
4765	404658
4766	404657
4767	401712
4769	404988
4770	404654
4771	404653
4772	404652
4773	404651
4778	401700

LECOY	SEIM
4779	401702
4780	554764
4782	405300
4783	401540
4784	554600
4785	401671
4787	653152
4794	554405
4795	554407
4796	554408
4797	554400
4798	554767
4799	554404
4802	653299
4811	554401
4826	554091
4827	554092
5002	710300
5003	710301
5004	713336
5005	713337
5006	710205
5008	710228
5009	713050
5010	713040
5011	710200
5012	710100
5013	713338
5014	713339
5031	710103
5032	710101
5035	713302
5043	710000
5046	554346
5047	710218
5054	710319
5055	554350
5057	554348
5058	554731
5066	710320
5067	554349
5069	554347
5070	710321
5250	733340
5251	733315
5261	733303
5262	733302
5265	733323
5266	733324
5267	554145
5268	554144
5269	731304
5270	731306
5271	731305
5272	731307
5273	554555
5274	554554
5277	554160
5278	554161

LECOY	SEIM
5279	554164
5280	554165
5281	554174
5282	554175
5283	554176
5284	554177
5285	554163
5286	554162
5289	554199
5290	554198
5291	554201
5292	554200
5293	554222
5294	554221
5295	554223
5296	554219
5297	554220
5298	554218
5301	554432
5302	554433
5303	554430
5304	554431
5339	554483
5345	554486
5348	554485
5351	554642
5352	554643
6046	303160
6085	355004
6087	355002
6088	355001
6091	554561
6092	734300
6093	554076
6094	554077
6501	722010
6502	723000
6503	721010
6504	721160
6505	721050
6506	721040
6508	721030
6509	721150
6517	720040
6520	721156
6521	721157
6526	723310
6527	723320
6528	723350
6529	721151
6531	723340
6532	723363
6533	721158
6535	723360
6538	723362
6539	723311
7000	600050
7001	600070
7004	600160

LECOY	SEIM
7005	600480
7011	600560
7012	600510
7013	600530
7015	600270
7016	600310
7029	603294
7035	603130
7040	603040
7041	603020
7045	600520
7046	600280
7071	600490
7072	600570
7075	600410
7079	600500
7080	600550
7083	603050
7084	603269
7085	603250
7086	600400
7094	122108
7095	122105
7096	600180
7097	600590
7098	600600
7100	600290
7103	603150
7104	603160
7105	603170
7108	603090
7109	603100
7111	603120
7112	600580
7113	554123
7115	600540
7120	600620
7122	600633
7124	603262
7126	603263
7129	603200
7130	603251
7131	602240
7132	603253
7133	603266
7134	603252
7135	600634
7138	600635
7142	603230
7143	602000
7150	084630
7152	603080
7153	603070
7154	603281
7155	603282
7169	122104
7170	600670
7174	122164
7175	600181

LECOY	SEIM	LECOY	SEIM	LECOY	SEIM	LECOY	SEIM
7176	603293	7446	653285	7740	553080	7868	554525
7179	603297	7447	653292	7742	550270	7869	554513
7180	603233	7448	653291	7745	553090	8025	703080
7182	603235	7449	653270	7751	550450	8042	703000
7183	603236	7450	653240	7752	550460	8046	703230
7184	603237	7452	554728	7753	550552	8058	703060
7185	603238	7454	653298	7757	550542	8059	701050
7187	603298	7460	653287	7759	553220	8065	703010
7188	554109	7461	653242	7764	550541	8066	703020
7189	554113	7462	653241	7766	553221	8071	701284
7192	603220	7464	653307	7769	122107	8072	701285
7193	554110	7465	554386	7771	553092	8076	084730
7195	554115	7467	554383	7774	553095	8079	701200
7196	603210	7468	554382	7775	553096	8081	703090
7197	554120	7469	554385	7777	721165	8082	703110
7198	603232	7470	554384	7778	550490	8089	700150
7199	554121	7471	554371	7779	553097	8090	700180
7200	603231	7472	653304	7780	553098	8091	700030
7201	554119	7473	653305	7782	550561	8094	703011
7202	554111	7474	554372	7783	550550	8096	701160
7203	554127	7475	554374	7784	553140	8099	701070
7204	554126	7476	554648	7786	553150	8100	701150
7205	554128	7481	554365	7787	721155	8105	703160
7206	554114	7500	554387	7788	550553	8106	703170
7209	554112	7502	554377	7789	553160	8107	702240
7210	554117	7510	554373	7790	553081	8108	703140
7211	554118	7661	550040	7793	553180	8109	703150
7222	554702	7664	550150	7794	553083	8113	084710
7223	554701	7666	550140	7795	553211	8117	703220
7242	554134	7668	550210	7796	553210	8118	701201
7332	653030	7669	550070	7797	553200	8121	700220
7337	653230	7670	554516	7798	554018	8124	701120
7338	650210	7671	550240	7799	554018	8126	084731
7340	650260	7672	550230	7810	553203	8127	701180
7368	650240	7673	550290	7811	553222	8129	703100
7369	650250	7676	550260	7819	723361	8138	084671
7396	653090	7677	550190	7824	553225	8139	084734
7397	084350	7678	550120	7825	553223	8139	084734
7400	650443	7682	550520	7826	553224	8140	703130
7401	650280	7683	550250	7827	553229	8141	703120
7404	653040	7684	553171	7828	554417	8143	701294
7405	653100	7684	553171	7837	554016	8145	701100
7406	653080	7699	550410	7838	554015	8146	701080
7409	653170	7709	550420	7840	554014	8148	084672
7410	653160	7710	550340	7842	554014	8148	084672
7411	650370	7711	550320	7843	553085	8149	703050
7415	853200	7722	550320	7843	554013	8152	554004
7422	653140	7722	553100	7844	554017	8186	603242
7425	653190	7725	553050	7847	554421	8187	701288
7426	653180	7726	553060	7849	554419	8192	700210
7432	653260	7727	553020	7852	554307	8197	701140
7433	653261	7730	550581	7853	554308	8198	701130
7434	650350	7731	550430	7854	554309	8199	703180
7435	650400	7732	550440	7855	554309	8200	703190
7438	650431	7733	553030	7855	554312	8201	703200
7439	650440	7734	553000	7856	554310	8203	703240
7440	650430	7735	553010	7857	554314	8204	701190
7441	650420	7736	553040	7858	554311	8204	701190
7444	652140	7737	550470	7859	554313	8205	701283
		7737	550470	7860	554315	8208	703310
		7738	550350	7865	554514	8209	703320
		7739	553070	7866	554526	8210	703350

LECOY	SEIM	LECOY	SEIM	LECOY	SEIM	LECOY	SEIM
8211	703360	8329	554206	30377	310204	82222	803950
8212	703390	8330	554207	30383	554773	82244	803880
8213	703400	8331	554101	30390	554775	82256	803920
8214	701230	8332	554096	32138	200130	82258	803900
8215	703494	8334	554569	32339	310200	82261	803961
8217	122100	8335	554571	32412	554809	82263	803990
8218	700202	8336	554570	32441	310205	82283	803760
8219	701250	8348	554745	32456	554782	82287	804050
8220	702250	8354	554028	32457	554778	82295	804010
8221	701210	8355	554031	34736	554832	82297	804190
8222	701240	8357	554030	34807	554823	82342	804241
8223	701220	8359	554029	34808	554821	82357	804251
8230	703498	8364	353003	34837	554825	82367	804270
8231	700200	8365	353004	34846	554806	82380	804261
8236	703440	8366	353001	37217	554793	82387	804293
8237	703430	8367	353002	37219	554792	82389	804301
8244	703420	8368	554331	38225	703490	82429	805125
8245	703410	8369	554335	45120	250824	82430	805022
8247	703460	8370	554334	45150	250821	82431	805027
8252	703340	8371	554027	45180	250825	82432	805030
8253	084450	8372	554330	80146	803550	82434	805029
8257	084660	8373	554337	80162	803630	83141	203640 +203650
8258	084661	8374	554336	80173	803610	84291	403970 X 2
8261	701281	8375	554333	80223	803650	84292	403960 +403970
8262	701282	8376	554332	80240	803720	84303	803700
8265	703450	8501	352310	80242	803690	84304	803710
8266	703470	8504	352000	80254	803730	84333	803980
8267	703480	8518	352200	80261	kit 554658	84348	803140
8268	084690	8522	554291	80285	803780	84352	804120
8271	701295	8523	352311	80301	803800	84353	804130
8272	122132	8524	554265	80308	803840	84363	804150
8278	554000	8525	554266	80309	803871	84365	804200
8279	554001	8526	352300	80311	803890	84374	804090
8280	554210	8527	554256	80317	803910	84418	804180
8281	554211	8528	554258	80319	803940	84423	804160
8283	122137	8529	554293	80327	803860	84458	804240
8284	122138	8530	554294	80330	803971	84466	804250
8285	703495	8531	554295	80335	804031	84479	804640
8286	703496	8532	554305	80340	804011	84495	804450
8292	703492	8533	554306	80350	804051	84496	804560
8293	554098	8548	554289	80352	804061	84497	803450
8295	703500	8549	554290	80353	804071	84541	804330
8296	703501	8555	554259	80354	804081	84543	804350
8298	703452	8556	554260	80356	804100	84555	804530
8299	703451	8557	554261	80357	804111	84556	804540
8300	703463	8558	554267	80360	805017	84599	804570
8301	703462	8559	554269	80361	805018	84608	804840
8302	703502	8560	554268	80364	805015	84617	804690
8306	703506	8561	554292	80376	805016	84618	404740
8307	703507	8562	554326	80378	805023	84620	404890
8308	703466	8563	554319	82082	803260	84620	404750
8310	554093	8564	554321	82102	103520 x 2	84639	804720
8311	703461	8565	554322	82123	803660	84647	804760
8312	554097	8566	554429	82136	203930 X 2	84649	804780
8313	554105	8571	554428	82139	803770	84674	804980
8314	554106	8729	554536	82168	803850	84676	804978
8319	554659	30253	103820	82171	803870	84686	804800
8320	554660	30344	310202	82175	803830		
8323	703467	30345	310203	82177	803810		

LECOY	SEIM
84688	804820
84690	804320
84703	804710
84708	404900
84710	404901
84734	404902
84737	804870
84754	804972
84757	804973
84758	804974
84763	804655
84765	804657
84826	805033
84827	805034
85067	805063
85069	805062
86535	853120
87000	800050
87204	805039
87222	805128
87368	650240 +650250
87409	853170
87666	850140
87671	850240
87673	853290
87678	850120
87734	853000
87735	853010
87784	853140
87790	553081 +553081
87793	853180
87824	853225
87825	805080
87840	805002
87842	853085
88109	803150
88140	803130
88199	803190
88265	803460
88278	805000
88371	805006
88372	805060
88376	805061
88559	805044
C003	500700
C004	500761
C005	500790
C006	500870
C008	500900
C009	500970
C012	500925
C020	500580
C022	500540
C023	500911
C024	501240
C025	500430
C026	500260

LECOY	SEIM
C027	501890
C028	500620
C029	501021
C035	501363
C036	500450
C041	500410
C046	500470
C048	500301
C051	500461
C053	500621
C055	500390
C056	500302
C058	500582
C059	500601
C061	500561
C063	500462
C207	501811
C210	500910
C215	501810
C218	500810
C219	500901
C228	501621
C229	501940
C230	500800
C231	500942
C238	554766
C239	501622
C240	501942
C242	501020
C257	502350
C265	500971
C267	500891
C279	502405
C281	500972
C296	500871
C298	500902
C299	500990
C407	501650
C415	501410
C418	501150
C419	501300
C420	502440
C421	501220
C423	501401
C425	501551
C426	501670
C427	501840
C428	500952
C430	501100
C431	501411
C438	501520
C440	501023
C441	501950
C445	501801
C450	502900
C451	501552
C452	500953
C470	505330
D003	505170

LECOY	SEIM
D201	500943
D207	500721
D211	502408
D212	501360
D217	500896
D218	501400
D219	501510
D220	501534
D221	501530
D228	501120
H000	505060
H005	505050
H008	505100
H011	505333
H012	505332
H013	505334
H014	505335
H015	505337
H016	505339
K330	505190
K332	505300
K334	505325
K342	505260
K344	505324
K350	505338
K353	505336
N662	505210
N664	505200
N665	505030
N668	505328
P008	505080
P020	505150
P021	505290
P027	505323
P028	505327
S007	056582
S009	059611
S014	063641
S023	114104
S024	122091
S025	122115
S026	122092
S028	122093
S029	122096
S032	122095
S212	019803
S213	061990
S216	059612
S222	064433
S223	082880
S228	063590
S229	062223
S230	114102
S235	010523
S236	083580
S238	114092
S239	106490
S240	122111
S241	122102

LECOY	SEIM
S244	122101
S245	122110
S246	064250
S247	042020
S248	107300
S252	122103
S256	122113
S258	122114
S259	107301
S261	122145
S330	114103
S332	122140
S334	122167
S336	122139
S338	122184
S405	082925
S406	018780
S407	064230
S412	061776
S415	082850
S419	064232
S429	114100
S431	054140
S433	114091
S437	122154
S438	122155
S439	122157
S440	122156
S441	122152
S442	122158
S443	122179
S444	122160
S445	122146
S446	122147
S447	122162
S454	122090
S661	122143
S662	122169
S666	122174
S667	122181
S668	122142
S669	122170
S670	114109
S700	122163
S801	714000
S950	114119

TRISCAN	SEIM
814010102	203750
814010118	204050
814010119	204060
814010123	553180
814010127	104080
814010128	104090
814010131	204295
814010134	204296
814010135	202470
814010137	554060

TRISCAN	SEIM	TRISCAN	SEIM	TRISCAN	SEIM	TRISCAN	SEIM
814010140	554062	814014189	555079	814018114	554991	814025191	404881
814010142	554051	814014190	555080	814018131	554989	814025192	404880
814010143	554050	814014191	555081	814018132	554197	814025196	404941
814010144	102440	814014192	555082	814021115	554880	814025197	404940
814010150	555037	814014205	710100	814021120	554879	814025198	404910
814010152	555036	814014207	710206	814021121	554870	814025201	401140
814010155	204294	814015118	703220	814021122	554871	814025207	400120
814010158	202361	814015131	703190	814021123	554872	814025213	400420
814010178	555032	814015132	703180	814021124	554874	814025216	400980
814010201	200150	814015143	202440	814021126	554878	814025218	401560
814010205	356203	814015144	103770	814021201	554561	814025219	401300
814010206	200510	814015172	703430	814023106	555021	814025221	401530
814010207	101340	814015180	703470	814023116	352310	814025222	401090
814010208	356202	814015184	703450	814023125	554292	814025223	401710
814010209	200560	814015223	701070	814023132	554263	814025224	401350
814010211	200580	814015234	701160	814023138	554278	814025227	401340
814010212	200511	814015243	701283	814023177	554267	814025230	401270
814010213	101341	814015248	701140	814023701	554800	814025233	401500
814010214	200520	814015261	701190	814024131	653030	814025240	401130
814010215	554565	814015263	701220	814024133	653180	814025243	401600
814010216	101781	814015264	701240	814024134	653170	814025244	401330
814010217	401690	814015274	554577	814024135	653160	814025246	401120
814010220	101780	814015276	554575	814024147	653270	814025247	400850
814010221	200522	814015278	101843	814024154	554374	814025249	400020
814010306	084130	814015280	101730	814024156	554373	814025250	401712
814010309	084390	814015321	700030	814024159	653240	814025251	554597
814010402	501530	814015712	554771	814024171	653242	814025252	401540
814010404	554654	814015713	554772	814024172	554391	814025253	401110
814010405	500990	814015714	554769	814024189	554728	814025254	401100
814010702	554773	814015717	554770	814024192	401520	814025259	401671
814010703	554778	814015724	554795	814024209	650443	814025260	401700
814010708	554789	814016138	603080	814024210	650280	814025261	401701
814010709	554788	814016156	603266	814024231	650370	814025269	401000
814010711	554806	814016187	603230	814024233	650400	814025273	400930
814010712	554807	814016188	603297	814024236	734200	814025274	400920
814010716	554786	814016201	600500	814024238	650430	814025310	084070
814010717	554787	814016203	600540	814025101	404160	814025314	082310
814010718	554808	814016208	600400	814025102	403140	814025318	084490
814011127	554331	814016212	600490	814025104	404240	814025319	084053
814011138	554864	814016228	600520	814025121	403040	814025321	084520
814011143	554330	814016229	600280	814025125	403980	814025329	122185
814011148	554867	814016232	600310	814025133	403970	814025339	084093
814011149	554866	814016242	600633	814025143	404100	814025347	122153
814011150	554865	814016243	600634	814025144	404090	814025360	084510
814011152	555044	814016244	600635	814025148	404650	814025401	500953
814011153	555043	814016302	554628	814025156	404430	814025402	501520
814011701	554801	814016702	554794	814025157	404570	814025403	501023
814011703	554802	814016705	554792	814025163	550430	814025405	501670
814012110	554857	814016706	554791	814025164	404250	814025406	500952
814012121	703501	814016707	554790	814025165	404820	814025409	501801
814012122	703500	814017139	555003	814025166	404830	814025411	501411
814012126	554001	814017140	555004	814025167	404800	814025412	501401
814012127	554000	814017141	554999	814025168	404810	814025417	501220
814012135	554861	814017142	554998	814025173	404320	814025701	554823
814012136	554858	814017143	555001	814025177	404760	814025702	554821
814012137	554859	814017144	555002	814025178	404770	814025703	554832
814014166	554731	814017145	555000	814025182	404975	814025707	554835
814014167	710321	814017146	554997	814025187	404350	814025708	554836
814014188	555078	814018113	554990	814025188	404360	814027124	554542

TRISCAN	SEIM
814027132	554543
814027139	554546
814028101	203660
814028102	203670
814028103	203770
814028104	203780
814028107	203830
814028108	203800
814028127	203880
814028131	203910
814028132	203920
814028133	203890
814028134	203900
814028145	103780
814028146	103840
814028150	204040
814028152	204020
814028153	204010
814028154	103800
814028156	204240
814028157	203960
814028158	204291
814028160	204190
814028163	103890
814028164	103900
814028165	103850
814028166	103860
814028169	204250
814028172	204260
814028173	204293
814028188	204297
814028196	554669
814028201	200160
814028203	200180
814028204	200100
814028208	200140
814028209	200200
814028211	200250
814028215	200270
814028216	200230
814028217	200640
814028219	200210
814028220	200340
814028221	200350
814028223	200280
814028224	200300
814028225	200310
814028226	200320
814028234	200490
814028235	200600
814028236	200610
814028237	101140
814028240	200521
814028241	200740
814028242	200750
814028243	200630
814028244	200440
814028248	101321
814028249	101351

TRISCAN	SEIM
814028251	200761
814028252	554664
814028253	200651
814028254	200701
814028255	200710
814028257	200370
814028259	200441
814028260	101844
814028262	200361
814028264	200731
814028265	200551
814028266	200120
814028267	554595
814028268	200751
814028269	200741
814028270	200780
814028271	200790
814028272	200721
814028273	200770
814028274	200791
814028275	554562
814028277	200760
814028278	200360
814028279	200700
814028280	200910
814028282	101840
814028283	200431
814028304	061783
814028309	122098
814028401	500902
814028404	500896
814028405	500971
814028408	404550
814028705	554809
814028902	310205
814028903	310204
814029114	550280
814029137	553000
814029150	553010
814029155	103810
814029157	553081
814029167	723360
814029169	553225
814029171	554502
814029172	553160
814029188	723362
814029201	550420
814029203	550260
814029218	550450
814029235	550440
814029242	721165
814029246	721155
814038101	103550
814038102	103610
814038115	103630
814038116	103740
814038117	103730
814038122	103700
814038123	103690

TRISCAN	SEIM
814038124	103710
814038125	103720
814038126	103910
814038127	103920
814038128	103930
814038129	103940
814038130	103790
814038131	104060
814038133	104030
814038134	104040
814038136	104050
814038137	104041
814038138	104010
814038145	554074
814038146	554075
814038154	103970
814038156	554901
814038160	554906
814038212	100990
814038215	100010
814038217	101000
814038220	101160
814038227	101110
814038228	101090
814038233	200380
814038234	101300
814038239	101310
814038240	101150
814038243	101830
814038244	101802
814038245	101331
814038249	101190
814038250	554564
814038251	101311
814038252	100900
814038403	500550
814038408	500561
814038409	500601
814038701	554782
814038702	554775
814040127	554392
814040128	731305
814040130	731307
814040131	059040
814040134	554955
814040135	554956
814040151	554554
814040152	554555
814040153	554959
814040154	554960
814040165	401190
814040166	554145
814040167	554953
814040169	554954
814040174	554957
814040175	554958
814042150	555048
814042151	555049
814042197	555050

TRISCAN	SEIM
814042198	555051
814043143	554963
814043144	554964
814043169	554967
814043172	554965
814043175	554961
814043195	554968
814043197	554966
814043199	554962
814050131	554226
814050132	554227
814050169	554241
814050175	555005
814050177	554942
814050178	554943
814050179	554946
814050180	554947
814050183	555006
814066105	723320
814066203	721151
814066207	721154
814067112	555116
814069147	554689
814069153	555118
814069154	555119
814069209	731204
814080106	554881
814080108	554983
814080112	554885
814080117	554979
814080118	554980
814080119	554982
814080120	554981
814080121	554892
814080123	554889
8140131121	554472
8140131220	555131
8140131221	555132
8140131222	555120
8140131223	555121
8140131224	555124
8140131229	555123
8140131230	555122
8140131236	555134
8140131276	555127
8140131277	555128
8140131293	555130
8140131294	555129
8140131295	555126
8140131296	555125
8140141100	555069
8140141101	555070
8140141102	555076
8140141103	555077
8140141106	555083
8140141111	555074
8140141112	555075
8140141120	555061
8140141127	555066

TRISCAN	SEIM
8140141128	555065
8140141129	555062
8140151010	554916
8140151011	554917
8140151018	554096
8140151020	554108
8140151026	554745
8140151037	554910
8140151038	554927
8140151039	554973
8140151040	554188
8140151040	554975
8140151041	554911
8140151042	554914
8140151043	554912
8140151044	554923
8140151045	554922
8140151051	554935
8140151052	554934
8140151053	554928
8140151054	554929
8140151055	554994
8140151056	554995
8140151057	554919
8140151059	554918
8140151060	554920
8140151061	554921
8140151062	554930
8140151063	554931
8140151066	554992
8140151067	554993
8140161109	554123
8140161129	554936
8140161130	554948
8140161136	554951
8140161152	554938
8140161155	554949
8140161160	554952
8140161161	554950
8140161162	554939
8140161163	554940
8140161168	554937
8140161170	554944
8140161171	554945
8140231103	555022
8140231104	555023
8140231106	555028
8140231107	555026
8140231108	555027
8140231109	555029
8140231113	555031
8140231115	555117
8140241109	554868
8140241113	555072
8140241114	555073
8140241115	555150
8140241116	555071
8140241121	555088
8140241122	555089

TRISCAN	SEIM
8140241129	555087
8140241130	555086
8140251104	404976
8140251110	404972
8140251121	403700
8140251123	405300
8140251127	404983
8140251128	404984
8140251135	404120
8140251138	103650
8140251153	554908
8140251154	554909
8140251160	555110
8140251162	555111
8140251163	555097
8140251166	404270
8140251171	404110
8140251178	402972
8140281109	555094
8140281112	555091
8140291100	554524
8140291112	554526
8140291129	554862
8140291130	554863
8140291132	555139
8140291135	554527
8140291138	555144
8140291139	555140
8140291140	555141
8140291141	555142
8140291142	555143
8140291145	555114
8140291146	555115
8140421111	555052
8140421112	555046
8140421120	555053
8140421121	555054
814028247A	101791
814028250A	101151

TRW	SEIM
GCC1219	600520
GCC1457	200230
GCC1002	100900
GCC1011	101000
GCC1016	100010
GCC1023	100990
GCC1025	100970
GCC1034	101050
GCC1041	101030
GCC1052	101160
GCC1054	101130
GCC1055	101240
GCC1059	101710
GCC1069	200150
GCC1119	701200
GCC1136	701150
GCC1145	701070

TRW	SEIM
GCC1151	701294
GCC1152	701080
GCC1205	600570
GCC121	600633
GCC1247	600490
GCC1277	600310
GCC1282	600280
GCC1287	600400
GCC1295	600590
GCC1307	600550
GCC1314	600500
GCC1369	650210
GCC1373	650260
GCC1379	650431
GCC1396	650280
GCC1400	650443
GCC1403	401260
GCC1408	401270
GCC1409	401090
GCC1413	554598
GCC1430	200100
GCC1433	200160
GCC1435	200140
GCC1438	200170
GCC1440	200120
GCC1443	200180
GCC1446	200210
GCC1448	200200
GCC1451	200270
GCC1453	200220
GCC1459	200640
GCC1464	200250
GCC1470	200320
GCC1472	200280
GCC1474	200300
GCC1482	200350
GCC1483	200340
GCC1516	401340
GCC1519	401330
GCC1522	554684
GCC1531	401120
GCC1532	401100
GCC1536	401180
GCC1537	401190
GCC1541	401170
GCC1548	401140
GCC1553	401350
GCC1556	401130
GCC1564	400020
GCC1570	400920
GCC1574	701000
GCC1577	550150
GCC1578	550070
GCC1584	550320
GCC1587	550420
GCC1662	710207
GCC1663	710206
GCC1665	101090
GCC1712	100950

TRW	SEIM
GCC1713	101190
GCC1715	200380
GCC1716	101300
GCC1717	101230
GCC1718	101210
GCC1719	101220
GCC1720	101260
GCC1721	101250
GCC1722	101311
GCC1723	200370
GCC1724	554595
GCC1725	101100
GCC1726	101110
GCC1727	101290
GCC1728	101280
GCC1729	554562
GCC1730	101350
GCC1732	200510
GCC1733	101341
GCC1734	200520
GCC1739	200770
GCC1740	200610
GCC1741	200741
GCC1742	200751
GCC1744	200360
GCC1750	200420
GCC1751	200440
GCC1752	200431
GCC1753	200780
GCC1755	400120
GCC1758	401300
GCC1759	401550
GCC1762	401500
GCC1763	401510
GCC1767	401610
GCC1768	401450
GCC1770	401490
GCC1771	401710
GCC1777	401600
GCC1781	550470
GCC1783	721155
GCC1789	550430
GCC1792	550542
GCC1794	550541
GCC1804	554605
GCC1813	650370
GCC1814	650400
GCC1816	650350
GCC1821	600540
GCC1825	355005
GCC1827	600580
GCC1830	600620
GCC1850	356202
GCC1858	721150
GCC1863	550553
GCC1891	731204
GCC1913	701100
GCC1914	701190
GCC1917	701283

TRW	SEIM
GCC1919	701160
GCC1925	701290
GCC1927	554579
GCC1928	701282
GCC1931	701140
GCC1932	701210
GCC1933	701220
GCC1934	554580
GCC1935	701240
GCC1937	701250
GCC1938	554573
GCC1941	701110
GCC1995	710100
GCC1999	710201
GCC2000	710204
GCC2004	200560
GCC2005	200790
GCC2006	200570
GCC2007	200580
GCC2010	200310
GCC3100	101830
GCC3101	554610
GCC3103	200760
GCC3105	550440
GCC3106	101791
GCC3108	101151
GCC3150	650430
GCC3151	734200
GCH1024	703110
GCH1034	103560
GCH1047	103610
GCH1049	103550
GCH1052	103680
GCH1054	103660
GCH1055	103650
GCH1056	103710
GCH1057	103720
GCH1058	103690
GCH1059	103700
GCH1064	103740
GCH1065	103730
GCH1067	103000
GCH1070	102420
GCH1071	203750
GCH1072	102400
GCH1081	703080
GCH1092	703000
GCH1099	703010
GCH1100	703120
GCH1103	703220
GCH1108	703090
GCH1109	703140
GCH1110	703150
GCH1111	703160
GCH1112	703170
GCH1115	703011
GCH1118	703130
GCH1120	703100
GCH1134	702240

TRW	SEIM
GCH1155	603050
GCH1187	603010
GCH1193	603080
GCH1198	603040
GCH1202	603294
GCH1247	650250
GCH1255	650240
GCH1256	653260
GCH1260	653190
GCH1261	653180
GCH1265	653100
GCH1266	653080
GCH1267	653090
GCH1292	203660
GCH1293	203670
GCH1294	203770
GCH1295	203780
GCH1296	203840
GCH1297	203850
GCH1298	203860
GCH1299	203870
GCH1300	203790
GCH1302	203830
GCH1303	203800
GCH1304	203810
GCH1305	203820
GCH1310	202360
GCH1311	202350
GCH1312	203940
GCH1313	203950
GCH1314	203880
GCH1315	203910
GCH1316	203920
GCH1317	203890
GCH1318	203900
GCH1322	203640
GCH1323	203650
GCH1340	203420
GCH1348	203450
GCH1349	203460
GCH1352	203730
GCH1356	203680
GCH1361	203930
GCH1378	404430
GCH1389	403140
GCH1393	404550
GCH1405	404090
GCH1406	404100
GCH1410	404630
GCH1417	403040
GCH1419	403030
GCH1420	403930
GCH1427	404210
GCH1428	404200
GCH1433	403980
GCH1434	404130
GCH1435	404120
GCH1442	404240
GCH1443	404250

TRW	SEIM
GCH1447	404350
GCH1448	404360
GCH1451	404500
GCH1472	403700
GCH1476	403710
GCH1481	403960
GCH1482	403970
GCH1513	723000
GCH1514	723363
GCH1515	554422
GCH1516	550120
GCH1518	550140
GCH1521	553100
GCH1526	553050
GCH1539	553097
GCH1544	553098
GCH1561	554019
GCH1577	356301
GCH1603	404270
GCH1605	202440
GCH1606	103770
GCH1633	203970
GCH1634	203960
GCH1651	653160
GCH1652	653170
GCH1653	550240
GCH1655	553010
GCH1656	553040
GCH1658	554018
GCH1666	550290
GCH1668	103780
GCH1669	103840
GCH1670	103850
GCH1673	103880
GCH1674	103890
GCH1675	352310
GCH1679	554029
GCH1681	554028
GCH1688	204050
GCH1690	763040
GCH1692	763030
GCH1695	103800
GCH1696	103810
GCH1697	103630
GCH1698	204020
GCH170	554051
GCH1703	204190
GCH1709	404320
GCH1710	404850
GCH1712	404830
GCH1713	404820
GCH1714	404810
GCH1715	103790
GCH1717	404570
GCH1718	404840
GCH1719	404670
GCH1723	404690
GCH1725	404530
GCH1726	404730

TRW	SEIM
GCH1727	404540
GCH1728	404720
GCH1730	404640
GCH1731	404650
GCH1733	404760
GCH1734	404770
GCH1735	404780
GCH1736	404790
GCH1747	404977
GCH1748	404975
GCH1750	204240
GCH1759	404800
GCH1767	553081
GCH1771	553095
GCH1772	553096
GCH1785	554030
GCH1786	554031
GCH1831	554291
GCH1832	554292
GCH1846	703340
GCH1849	202361
GCH1853	803190
GCH1854	703190
GCH1858	703430
GCH1867	703360
GCH1877	554094
GCH1901	603150
GCH1903	603160
GCH1904	602240
GCH1905	554122
GCH1916	603251
GCH1926	603100
GCH1928	603120
GCH1929	603262
GCH1934	553180
GCH1935	713300
GCH1943	603282
GCH1957	731305
GCH1958	731306
GCH1959	731307
GCH1972	731318
GCH1973	731319
GCH1998	554150
GCH1999	554151
GCH2000	554152
GCH2001	554153
GCH2027	554209
GCH2029	554208
GCH2037	554227
GCH2038	554226
GCH2091	653040
GCH2094	653140
GCH2095	653298
GCH2096	554365
GCH2098	653240
GCH2102	103760
GCH2105	653270
GCH2107	653292
GCH2115	103750

TRW	SEIM
GCH2156	723320
GCH2159	723350
GCH2160	553000
GCH2181	733502
GCH2182	733503
GCH224	554731
GCH226	710321
GCH2297	554532
GCH2298	554533
GCH2308	554549
GCH2310	554542
GCH2314	554516
GCH2319	554517
GCH2324	554502
GCH2329	553160
GCH2331	553060
GCH2332	554512
GCH2337	554518
GCH2357	713040
GCH2358	713050
GCH2416	204070
GCH2417	204080
GCH2421	103910
GCH2422	103930
GCH2423	103920
GCH2424	103940
GCH2425	103870
GCH2427	103860
GCH2430	103900
GCH2431	703490
GCH2501	554225
GCH2502	554224
GCH2510	554392
GCH2512	653241
GCH2514	653242
GCH2516	554367
GCH2518	104030
GCH2519	104040
GCH2523	204250
GCH2537	554025
GCH2541	554045
GCH2542	104041
GCH2551	103970
GCH2555	731304
GCH2558	554555
GCH2559	554554
GCH2566	204040
GCH2567	204060
GCH2568	204010
GCH2571	204293
GCH2574	554513
GCH2575	554514
GCH2576	554442
GCH2577	554441
GCH2578	554524
GCH2579	554097
GCH2583	554000
GCH2590	554026
GCH2595	554264

TRW	SEIM
GCH2596	554265
GCH2597	554266
GCH2605	554428
GCH2615	703470
GCH2618	554373
GCH2619	554371
GCH2620	554372
GCH2623	554374
GCH2626	204260
GCH2629	104050
GCH2631	103950
GCH2632	554001
GCH2635	554334
GCH2636	554335
GCH2638	554467
GCH2639	554468
GCH2644	554022
GCH2645	554046
GCH2646	554037
GCH2647	554038
GCH2649	554418
GCH2651	554175
GCH2652	554174
GCH2654	104080
GCH2660	554387
GCH2661	554386
GCH2662	703501
GCH2663	703500
GCH2684	554024
GCH5006	803690
GCH5008	803650
GCH5011	803880
GCH5014	803920
GCH5016	803830
GCH5027	803140
GCH5030	803980
GCH5033	804160
GCH5034	804130
GCH5035	804120
GCH5036	804150
GCH5037	803700
GCH5042	804450



Lined area for notes with horizontal dotted lines.



Lined area for notes with horizontal dotted lines.



Lined area for notes with horizontal dotted lines.

Retour Garantie

Garantie

Tous les produits MGI COUTIER SEIM bénéficient d'une garantie contre tous vices de fabrication pendant une période d'un an à compter de la date de livraison. Cette garantie est limitée au remplacement gratuit ou au remboursement des produits reconnus défectueux par MGI COUTIER SEIM.

Toute demande de garantie pourra être refusée dans les cas suivants :

- Mauvaises conditions de stockage du produit,
- Installation non conforme aux règles de l'art et/ou aux notices.
- Adaptations et/ou modifications du produit.
- Mauvais fonctionnement résultant d'adjonction de pièces ou de dispositifs ne provenant pas de MGI COUTIER SEIM.

Procédure

Pour toute demande de retour garantie il faut impérativement accompagner les produits défectueux avec un formulaire de retour garantie (un par pièce retournée) dûment renseigné. Ce formulaire est disponible auprès de notre service ADV au **Tél. 04 74 46 07 34** ou téléchargeable sur notre site **www.seim.fr**

Il est également possible de contacter le commercial de son secteur pour expertiser les pièces sur place et juger du droit (ou non) à la garantie. En cas de doute, le commercial pourra demander au client d'envoyer son retour, accompagné du formulaire de retour garantie, chez MGI COUTIER SEIM.

Toute demande de retour garantie sans formulaire sera systématiquement refusée par nos services.

Adresse de retour :

**MGI COUTIER SEIM
Service Retour Garantie
Rue de la Gare
01800 VILLIEU**

Après réception des produits en garantie accompagnés du formulaire de retour, le service technique et qualité s'engage à les expertiser et transmettre les résultats au client sous un délai d'un mois. En cas d'acceptation du retour garantie par MGI COUTIER SEIM, le service ADV effectuera un avoir de compensation au client.

Le service commercial

Notre réseau de distribution

Our distribution network

Des agences commerciales dans le monde entier

Worldwide sales agencies

GERMANY | BELGIUM | DENMARK | SPAIN | GREECE | ITALY | POLAND | TURKEY | UNITED KINGDOM |
NORTH AFRICA | ARGENTINA | COLOMBIA

+33 (0) 4 74 46 32 25

FRANCE



HOLLEBECQ Jean-Christian

Tél. : +33 (0) 6 07 06 86 09

Email : holle@wanadoo.fr

Départements : 02 / 59 / 60 / 62 / 76 / 80



ESNAULT Gérard

Tél. : +33 (0) 6 07 21 03 91

Email : esnault44@free.fr

Départements : 14 / 22 / 27 / 28 / 29 / 35 / 37 / 44 / 49 /
50 / 53 / 56 / 61 / 72 / 79 / 85 / 86



CORBIN Thierry

Tél. : +33 (0) 6 07 28 76 97

Email : tcorbin@free.fr

Départements : 09 / 11 / 12 / 15 / 16 / 17 / 19 / 23 / 24 /
31 / 32 / 33 / 40 / 46 / 47 / 64 / 65 / 66 / 81 / 82 / 87



BAUMGARTEN Franck

Tél. : +33 (0) 6 87 82 99 07

Email : franck.baumgarten@mgicoutier.fr

Départements : 08 / 10 / 18 / 36 / 41 / 45 / 51 / 52 /
54 / 55 / 57 / 67 / 68 / 70 / 75 / 77 / 78 / 88 / 90 / 91 /
92 / 93 / 94 / 95



CROUTTE Joël

Tél. : +33 (0) 6 09 30 19 96

Email : joel.croutte@wanadoo.fr

Départements : 01 / 03 / 07 / 21 / 25 / 26 / 38 / 39 /
42 / 43 / 48 / 58 / 63 / 69 / 71 / 73 / 74 / 89



ZARAGOZA Jean-jacques

Tél. : +33 (0) 6 14 51 00 16

Email : zaragoza@wanadoo.fr

Départements : 04 / 05 / 06 / 13 / 2A / 2B / 30 / 34 /
83 / 84

Nos dépôts pour mieux vous servir



NORD EQUIP AUTO

Rue Chalant - 59 790 RONCHIN

Tél. : +33 (0) 3 20 53 37 43



BG DISTRIBUTION

44, avenue du Général de Gaulle - 92 230 GENNEVILLIERS

Tél. : +33 (0) 1 41 21 05 45



CENTRAL DEPOT

4, rue Etienne Dolet - 18 100 VIERZON

Tél. : +33 (0) 2 48 71 33 99



RICHE DIFFUSION

ZI - 12, rue des Tisserands CP3119 - 44 806 SAINT HERBLAIN

Tél. : +33 (0) 2 28 03 12 12



BEZIAT

34, rue Marcel Delattre - 33 321 BEGLES Cedex

Tél. : +33 (0) 5 56 49 54 44



MAGNE

13, avenue de Fondreyre - 31 200 TOULOUSE

Tél. : +33 (0) 5 61 47 79 32



MARSEILLE DEPOT

375, boulevard National - 13 003 MARSEILLE

Tél. : +33 (0) 4 91 50 70 44



AUTO DEPOT LYONNAIS

1, rue Emile Zola - 69 150 DECINES-CHARPIEU

Tél. : +33 (0) 4 78 80 22 81



STOCK CENTRAL DE VILLIEU

Rue de la Gare - Villieu - 01 800 MEXIMIEUX FRANCE

Tél. : +33 (0) 4 74 46 07 34



FED NANCY 54

48, avenue de la Paix - 54 510 TOMBLAINE

Tél. : +33 (0) 3 83 18 01 70



Rue de la Gare

01 800 VILLIEU (France)

Tél. : +33 (0) 4 74 46 07 34

Fax. : +33 (0) 4 74 61 38 14



seim

MGI COUTIER

N° SIRET 344 844 998 RCS Bourg-en-Bresse
CODE APE : 343 Z
INTRACOM : FR 33 344 844 998

A global automotive supplier offering superior support to independant aftermarket